



PRICE BOOK

Prices Effective June 1, 2025

greatopenings.com

Updates and revisions to this book:

Date	Page	Update
5-7-25		Price adjustments
8-5-25		Addition of Laminate Pedestal and Laminate Chester
8-8-25	12	Price adjustments for additional keys
8-8-25	21	Price correction for COM Fabric
8-11-25		Price correction for COM Fabrics on multiple products
9-18-25		Moved Laminate Pedestal and Laminate Chester to Laminate Price Book
10-22-25		Added new 65-7/8" 3 H Cubbys
11-7-25	134	Updates to GSA Terms and Conditions
1-28-26	31	Added Adjustable Shelves
2-19-26	44	Lateral Islands - Addition
3-11-26	Multiple	Removed discontinued products (Bill, Cayenne Stack-on Cube, Pete, Sly, Ben, Sofia, Lily, and Flip)
6-2-26	18	Addition of GOcart
6-2-26	15	Updates to Marty



Specification Guide

- 4 Quick Reference for Ordering
- 5 Metal Colors
- 6 Laminates
- 9 Fabrics
- 11 Locks
- 12 Key Alike
- 13 Product Care and Maintenance

Trace Personal Storage & Pedestals

- 14 Specifications
- 15 Personal Storage
- 20 Pedestals
- 21 Designer Pedestal
- 21 Under Work Surface Storage
- 22 Freestanding Pedestals
- 23 Pedestal Accessories

Trace Lateral Files

- 24 Specifications
- 25 Lateral Files
- 31 Laminate Tops - Trace Laterals
- 35 Trace Lateral Accessories

Recessed Front Lateral Files

- 37 Specifications
- 38 Lateral Files
- 40 Recessed Door Lateral Files
- 42 Laminate Tops - Recessed Front Laterals
- 43 Recessed Front Lateral Accessories

Collaboration Islands

- 44 Specifications

Trace Lockers

- 46 Specifications
- 48 Metal Lockers
- 57 Metal Locker Accessories
- 58 Ganging Kit & Locker Door Number Plates
- 59 Laminate Lockers
- 67 Laminate Locker Accessories
- 68 Laminate Tops - Lockers
- 69 How to Order Multicolored Locker Doors

Trace Wardrobe Towers

- 78 Specifications
- 79 Wardrobe Towers

Storage Cabinets

- 84 Specifications
- 85 Double Door Storage Cabinets
- 88 Laminate base Cabinets

Trace Bookcases

- 89 Specifications
- 90 Bookcases

Cayenne Storage

- 93 Specifications
- 94 Cayenne Storage
- 97 Cayenne Accessories

Height Adjustable Tables

- 99 Specifications
- 100 Height Adjustable Tables

Trace Freestanding Desks

- 101 Specifications
- 105 Trace Bare Bones Desks
- 106 Trace Desk Shells
- 107 Trace Corner Desks
- 112 Trace Extended Corner Desks
- 113 Trace Extended Corner Desks End-of-Run
- 114 Trace Bridge Desks
- 115 Trace Desk Components Sold Separately
- 117 Trace Desk Modesty Panels Sold Separately
- 118 Trace Desk Work Surface Panels Sold Separately

Desk Accessories

- 119 Work Surface Stiffeners
- 119 Desk Hutch
- 122 Task Lighting
- 120 Personal Drawer
- 122 Acrylic Screens
- 122 Metal Modesty Panels
- 123 Tackable Privacy Screens
- 125 Desk Accessories

Sparkeology

- 126 Cupcake
- 126 Oscar

127 Commercial Terms & Conditions

129 GSA Terms & Conditions

Great Openings Price Book

Great Openings
902 E. 4th Street
Ludington, MI 49431

Customer Service:
Phone: 888-712-8582
goorders@greatopenings.com

www.greatopenings.com
Printed Literature: www.goliterature.com

QUICK REFERENCE FOR ORDERING

All drawer fronts are not available on all products. For restrictions see the individual product pages.

A: Full Pull

B: S-9000 Pull

D: Radiused, Recessed Pull

D: and F: Recessed Pull Colors:
 0256 Black Umber
 0257 Light Grey
 0004 Medium Tone

Q: Square, Satin Nickel Bar Pull

F: Square, Recessed Pull

I: Radiused, HW Pull

S: Square, Satin Nickel Loop Pull
 (Add "B" suffix for black pull)

H: Square, HW Pull

N: Radiused, Satin Nickel Loop Pull
 (Add "B" suffix for black pull)

P: Square, P Pull

P: Square Front "P" Pull Colors:
 0159 Beige
 0006 Charcoal
 0547 Graphite
 0131 Smoke

Products ordered in any other color will include 0006 Charcoal pulls

Standard Paint Finishes

Allsteel	Herman Miller	Steelcase
0217 Brilliant White	0256 Black Umber	0995 Arctic White Textured
01A7 Champagne Metallic	0257 Light Grey	0668 Black Textured
0073 Cloud	0004 Medium Tone	0044 Black
0232 Driftwood	0001 Dark Tone	0998 Carbon Metallic Textured
0231 Flint	0744 Metallic Champagne	0678 Fieldstone Textured
0536 Loft	0666 Silver Metallic	0722 Midnight Textured
0683 Muslin	02L6 Soft White	02A4 Milk
0345 Parchment	0784 Warm Grey Neutral	0666 Platinum Metallic
0166 Platinum Metallic	0348 Innertone Light	0705 Sterling Metallic
0239 Fossil		0280 Warm White
Haworth	Knoll	Teknion
0159 Beige	0968 Beige Mist Metallic	02M0 Arctic Textured
0228 Cement Textured	0222 Bright White Smooth	02X5 Espresso Textured
0141 Chalk	02Z3 Bright White Textured	02M3 Granite
0006 Charcoal	02Y7 Brown	02A3 Grey
0547 Graphite	0623 Folkstone Grey	02U2 Latte Textured
0205 Greystone	0188 Medium Grey	02M2 Nevada
0229 Grout Textured	02Y6 Medium Metallic Grey	02X7 Platinum Metallic
0112 Putty	0756 Sandstone	02Z0 Satin Black
02Y9 Silver Metallic	02X9 Silver Metallic	02X4 Silver Textured
0131 Smoke	0030 Soft Grey	02N0 Storm White Textured

Laminates

GO Part #	HPL Laminate	Brand Code
DWDW	Designer White	Wilsonart D354-60 HPL
BKBK	Black	Wilsonart 1595-60 HPL
FGFG	Fashion Grey	Wilsonart 381-60 HPL
SGSG	Shadow	Wilsonart D96-60 HPL
DMGH	Slate Grey	Wilsonart D91-60 HPL
DZDZ	Desert Zephyr	Wilsonart 4841-60 HPL
SLSL	Steel Mesh	Wilsonart 4879-38 HPL
GYGY	Grey Mesh	Wilsonart 4877-38 HPL
B4B4	Bleached Legno	Formica 8845-58 HPL
NNNN	Neutral Twill	Formica 8826-58 HPL
S8S8	Sarum Twill	Formica 8827-58 HPL
BGBG	Brighton Walnut	Wilsonart 7922K-07 HPL
RHRH	River Cherry	Wilsonart 7937-38 HPL
CBBC	Biltmore Cherry	Wilsonart 7924K-07 HPL
WCWC	Wild Cherry	Wilsonart 7054-60 HPL
KMKM	Kensington Maple	Wilsonart 10776-60 HPL
GO Part #	TFL Laminate	Brand Code
M-1573-60	Frosty White	Wilsonart M-1573-60
M-BKBK	Black	Wilsonart M-1595-60
M-FGFG	Fashion Grey	Wilsonart M-381-60

Dwelling Color Paint Finishes

03Q9	Special Gray
03Q7	Bracing Blue
03Q8	Honest Blue
03Q0	Retreat
03Q1	Riverway
03P9	Independent Gold
03Q4	Jonquil
03P8	Garden Sage
03Q5	Emberglow
03Q3	Chamois
03Q6	Brandywine
03Q2	Antique Red

C.F. Stinson New Hempstead Fabrics

GO Part #	Fabric	New Hempstead #
7A	Black	NH333
8Q	Azure	NH359
7C	Nickel	NH361
7J	Steel	NH366
7K	Navy	NH369
8R	Red Red Wine	NH389
7B	Grey	NH395
8M	Cocoa	NH424

C.F. Stinson Sprint Fabrics

GO Part #	Sprint	GO Part #	Sprint
64020	Mist	64030	Rust
64021	Ivory	64031	Nocturne
64022	Quarry	64032	Storm
64023	Turquoise	64033	Driftwood
64024	Gold	64034	Cherry
64025	Twig	64035	Cordovan
64026	Graphite	64036	Blackberry
64027	Fern	64037	Peat
64028	Breeze	64038	Abyss
64029	Blaze		

METAL COLORS

All Great Openings products are finished with a hybrid powder formula (epoxy and polyester), which ensures an exceptionally durable, consistent finish. Simply select from our 72 Standard Colors, Industry Favorites (viewed online), or Custom Colors.

72 STANDARD COLORS

All at standard lead times and price, standard colors are smooth, except those identified as textured.

Allsteel		Steelcase		Knoll		Dwelling Color Palette	
0217	Brilliant White	0995	Arctic White Textured	0968	Beige Mist Metallic	03Q9	Special Gray
01A7	Champagne Metallic	0668	Black Textured	02Z2	Bright White Smooth	03Q7	Bracing Blue
0073	Cloud	0044	Black	02Z3	Bright White Textured	03Q8	Honest Blue
0232	Driftwood	0998	Carbon Metallic Textured	02Y7	Brown	03Q0	Retreat
0231	Flint	0678	Fieldstone Textured	0623	Folkstone Grey	03Q1	Riverway
0536	Loft	0722	Midnight Textured	0188	Medium Grey	03P9	Independent Gold
0683	Muslin	02A4	Milk	02Y6	Medium Metallic Grey	03Q4	Jonquil
0345	Parchment	0666	Platinum Metallic	0756	Sandstone	03P8	Garden Sage
0166	Platinum Metallic	0705	Sterling Metallic	02X9	Silver Metallic	03Q5	Emberglow
0239	Fossil	0280	Warm White	0030	Soft Grey	03Q3	Chamois
		Haworth		Teknion		03Q6	Brandywine
0256	Black Umber	0159	Beige	02M0	Arctic Textured	03Q2	Antique Red
0257	Light Grey	02Z8	Cement Textured	02X5	Espresso Textured		
0004	Medium Tone	0141	Chalk	02M3	Granite		
0001	Dark Tone	0006	Charcoal	02A3	Grey		
0744	Metallic Champagne	0547	Graphite	02U2	Latte Textured		
0666	Silver Metallic	0205	Greystone	02M2	Nevada		
02L6	Soft White	02Z9	Grout Textured	02X7	Platinum Metallic		
0784	Warm Grey Neutral	0112	Putty	02Z0	Satin Black		
0348	Innertone Light	02Y9	Silver Metallic	02X4	Silver Textured		
		0131	Smoke	02N0	Storm White Textured		

CUSTOM COLORS

When you need a color that's not included in our 72 Standard Colors or Industry Favorites, simply send us a paint chip and we'll get it matched. A special lead time or cost will likely be included, but we can almost certainly supply exactly the color you need.

- No minimum order size on Custom Colors
- Custom Color up-charge is applied on a per unit basis
- Minimum lead-time is 15 working days after we receive your written color approval
- We must receive a purchase order before exchanging custom color samples.

Check our website for Custom Color Idea Starters, a sampling of trending new custom colors!

Here's how it works for custom colors:

1. Along with your purchase order, send us a 2" X 2" sample of your desired Custom Color (a metal chip is best, but often a laminate or paper sample will work).
2. We'll work with our paint suppliers to find a match, a process that typically takes 10 to 15 business days. Then we'll send a metal sample of our recommended paint color back to you, along with a sign-off sheet, total net up-charge, and lead-time requirements.
3. You'll return the sign-off sheet, we'll send you an order acknowledgment, and away we go!

Two-tone cabinets, with fronts painted a different color than the cabinet are available. Contact Sales for a quote.

Please note: Our objective is to order exactly the correct amount of paint for each order so that we can offer you the lowest possible price. For this reason, if you happen to order the same custom color again weeks, months, or years later, paint inventory will likely not exist and any additional costs will once again be charged per unit, no matter the order size.

Great Openings Laminate Program

Great Openings offers the laminates listed below, at a standard price and lead time. We also make it easy to order other laminates and edge bands, as described below as "Special Laminates". For memo samples, please go to wilsonart.com or formica.com.

HPL and TFL Laminates

<https://www.greatopenings.com/finish-center/standard-laminates/>

Special Laminates

When you need a laminate or edge band that's not included in our Standard Laminates & Edges, call Great Openings to request a special quote and lead-time. We have access to WilsonArt®, Formica®, Nevamar®, Pionite® and many more.

Please note that special laminates or edges will require additional charges, lead-time, and minimum order quantities.

When it's time to place your custom laminate order, include the following information on your PO:

- name of your laminate and edge
- manufacturer names
- pattern names
- identification numbers

Special laminates and edges cannot be changed or canceled after the order has been confirmed by our Customer Service Department and an order acknowledgment has been sent.

Standard Work Surface Specifications

Specifications for (HPL) high pressure laminate work surfaces, cabinet tops, and drawer fronts

- Industrial grade particleboard, single-sided decorative laminate overlay
- High performance, high pressure laminate backer
- California Air Regulation Board Compliant to Phase 2. FSC Controlled Wood Status
- Water based, formaldehyde free, GREENGUARD® certified adhesive
- Finished thickness of horizontal application work surfaces is 1.2"
- Finished thickness of vertical application drawer fronts and doors is .8"
- Edge bands are 2mm or 3mm
- Cayenne laminate tops are 5/8" thick

Specifications for (HPL) high pressure laminate doors

- Identical to the specification shown above, except doors feature two-sided decorative high pressure laminate, so the appearance is identical inside and out



Specifications for (TFL) thermal fused laminates for drawer fronts and doors

- TFL is a cost effective, durable product used on vertical services such as drawer fronts and doors
- TFL offers the same abrasion resistance as High Pressure Laminate and slightly less impact resistance, therefore it's appropriate for use on drawer fronts and doors. Thermal Fused Laminates do not meet NEMA specification requirements, scratch resistance, or ball drop tests
- Doors feature two-sided decorative TFL, so the appearance is identical inside and out
- California Air Regulation Board Compliant to Phase 2. FSC Controlled Wood Status
- Finished thickness of TFL drawer fronts and doors is .75"
- Edge bands are 2mm or 3mm (identical to those used on HPL fronts)

LAMINATES

Products Available with Laminate Fronts

Any of the following Great Openings cabinets may be special-ordered to include factory-installed laminate fronts. Laminates may be one of Great Openings' standards, or a special ordered laminate. Laminate wood grain is positioned vertically on all fronts, including tower doors. Laminate fronts must be specified to include any one of our loop pulls. UM Series locks are included as standard. When ordering more than 50 of any single laminate size, please call Sales for a quote.

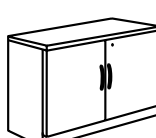
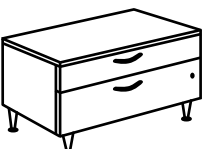
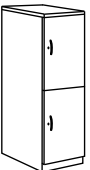
	Notes	Product
	<p>Pedestal drawer fronts and lock strip will be laminate. Cushion pedestals will not include a loop pull on the lock strip. Not available on 3" pencil drawers.</p>	<p>box/file pedestal file/file pedestal box/box/file pedestal</p>
	<p>Lateral drawer fronts and lock strip will be laminate. The lateral top and base are both visible from the front of the cabinet, and will be metal.</p>	<p>Box/file lateral (any width) 2-high lateral (any width) 3-high lateral (any width) 4-high lateral (any width) 5-high lateral (any width) 6-high lateral (any width)</p>
	<p>Laminate drawer and door fronts are full-width. The tower top and base are both visible from the front of the cabinet, and will be metal.</p>	<p>Cupboard wardrobe tower (any height)</p>
	<p>Double door storage fronts are full-width. The cabinet top and base are both visible from the front of the cabinet, and will be metal.</p>	<p>2-high storage cabinet (any width) 3-high double door cabinet (any width)</p>
	<p>Cayenne drawer fronts are full width, and the lock is located in the bottom drawer.</p>	<p>Cayenne two drawer cabinet (any width)</p>
	<p>In the locker section of this pricebook, you'll find laminate front options already priced, as an alternative to metal fronts.</p>	

FABRICS

Fabrics

Great Openings has graded programs with C.F. Stinson and Maharam, and fabric swatches may be ordered directly from them. Please check greatopenings.com for our current fabrics and grades.

For your convenience, we display 28 C.F. Stinson fabrics in our finish card and price book, just to make it simple to pick a low texture, solid color, 100% polyester fabric. All of these “standard” fabrics are priced at GRADE 1.

GO Part #	Fabric	C.F. Stinson New Hempstead #	GO Part #	C.F. Stinson Sprint Fabric	GO Part #	C.F. Stinson Sprint Fabric
7A	Black	NH333	64020	Mist	64030	Rust
8Q	Azure	NH359	64021	Ivory	64031	Nocturne
7C	Nickel	NH361	64022	Quarry	64032	Storm
7J	Steel	NH366	64023	Turquoise	64033	Driftwood
7K	Navy	NH369	64024	Gold	64034	Cherry
8R	Red Red Wine	NH389	64025	Twig	64035	Cordovan
7B	Grey	NH395	64026	Graphite	64036	Blackberry
8M	Cocoa	NH424	64027	Fern	64037	Peat
			64028	Breeze	64038	Abyss
			64029	Blaze		

For memo samples, contact C.F. Stinson at 800-841-6279 or see www.cfstinson.com.

Fabric Specifications

- Contents..... 100% polyester
- Finish..... Soil and stain protective finish
- Abrasion Resistance (astm d-4157) Exceeds 100,000 (Bryant Park), and 800,000 (New Hempstead) double rubs (heavy duty Wyzenbeek Method)
- Color Fastness - Light (aatcc-16)..... 40 hours class 4 minutes (New Hempstead), and 5 minutes (Bryant Park)
- Crocking (aatcc-8) (dry) class 4.5 minutes (wet) class 4.5 minutes
- Flammability:
 - Calif. 191-53 Tech. Bulletin 117, Section E..... Passes
 - UFAC and BIFMA Class 1
- Cleaning (w-s)..... Professional service is recommended or use water-based agents

Unless otherwise specified, the fabric grain on all cushions will be applied "front-to-back" as shown below.

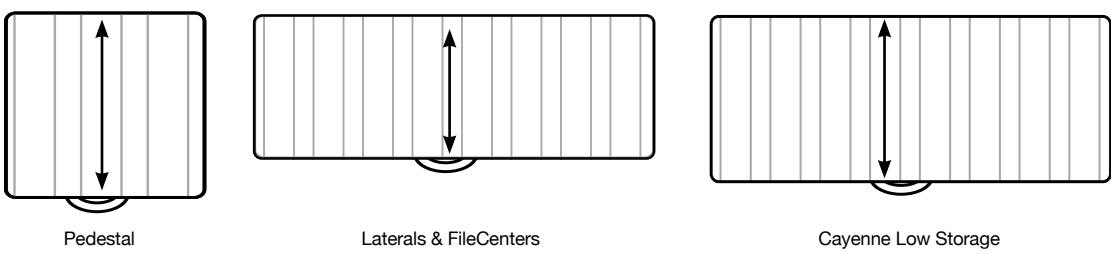

FABRICS

How to specify COM fabric on your purchase order:





Calculate the yards of fabric needed using the chart below. If ordering more than 20 identical units, call for fabric requirements

Clearly label your fabric package with:

- Purchase order #
- Dealer name
- Fabric description
- Yardage quantity enclosed



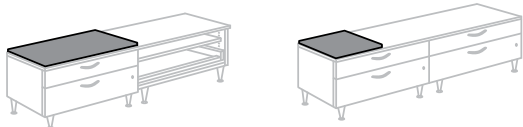
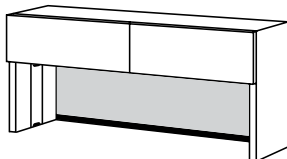

Send the fabric to:

Great Openings (Fabric), 901 East Sixth St., Ludington, MI 49431
 Please note PO or Sales order

Product	Required Yardage
 <p>Cushion FileCenter Cushion Pedestal Molly</p>	<p>Required for 54" or 66" fabric</p> <p>1 linear yard per unit</p>
 <p>Slim</p>	<p>Required for 54" or 66" fabric</p> <p>Slim (3/4 linear yard per unit)</p>
 <p>Trace Box/File Lateral Cushions</p>	<p>Required for 54" or 66" fabric</p> <p>•30", 36", and 42" wide laterals (3/4 linear yard)</p>
 <p>Cayenne Cushion</p>	<p>Required for 54" or 66" fabric</p> <p>12" wide cushion (3/4 linear yard) 18" wide cushion (3/4 linear yard) 30" wide cushion (3/4 linear yard) 36" wide cushion (3/4 linear yards) 42" wide cushion (3/4 linear yards)</p>
 <p>Desk Hutch</p>	<p>Required for 54" or 66" fabric</p> <ul style="list-style-type: none"> • 36" wide tack board requires 42" fabric (1-1/2 linear yard) • 42" wide tack board requires 48" fabric (1-1/2 linear yards) • 48" wide tack board requires 54" fabric (1-1/2 linear yards) • 54" wide tack board requires 66" fabric (2 linear yards) • 60" wide tack board requires 66" fabric (2 linear yards) • 66" wide tack board requires 72" fabric (2 linear yards) • 72" wide tack board requires 77" fabric (2-1/2 linear yards)
 <p>Rectangle Screen Scalloped-Shaped Screen</p>	<p>Required for 54" or 66" fabric</p> <ul style="list-style-type: none"> • 23" wide screen requires 29" fabric (1 linear yard) • 29" wide screen requires 35" fabric (1 linear yard) • 35" wide screen requires 41" fabric (1-1/2 linear yards) • 41" wide screen requires 47" fabric (1-1/2 linear yards) • 47" wide screen requires 53" fabric (1-1/2 linear yards) • 59" wide screen requires 65" fabric (2 linear yards) • 65" wide screen requires 71" fabric (2 linear yards) • 71" wide screen requires 77" fabric (2-1/2 linear yards)

The scalloped-shaped screens require the same amount of fabric as the rectangular screens. The 20-3/4" and 12" screen height dimension will be taken from the width of the cloth.

KEYED LOCKS

	UM (G) (our standard lock)	LL (Z)	SL (H)	ML (H)	HW (Z)	K (G)
						
	Black Patent	Satin Nickel, Scalloped	Grey Scalloped	Grey Scalloped	Satin Nickel, Scalloped	Black Patent
Compatible with which other Manufacturers?	Herman Miller	None	Haworth SL	Haworth ML	Haworth HW	Knoll Series
Interchangeable with other manufacturers' locks?	Interchangeable key and core	N/A	Interchangeable key and core	Interchangeable key and core	N/A	You cannot interchange K Series cores between Great Openings and Knoll products, but our "K" keys will operate Knoll's "K" locks, and vice versa
Description	As standard, all GO products are shipped with a randomly-assigned UM lock, which is black, master-keyed, and core removable	The LL lock is master-keyed and core removable	There is no master-key available for SL locks	Great Openings does not offer the Haworth ML series lock, but Haworth's ML lock cores will operate in our SL Lock mechanism Order the SL lock and then replace the cores and keys with ML in the field. It is the dealer's responsibility to source and provide the ML cores and keys	Great Openings does not offer the Haworth HW series lock, but Haworth's HW lock cores will operate in our LL Lock mechanism Order the LL lock and then replace the cores and keys with HW in the field. It is the dealer's responsibility to source and provide the HW cores and keys	Our K Series cores and keys will operate the Knoll K Series locks Order the UM Series lock and then replace the cores and keys with K Series in the field We support a key range of K-001 through K-100; should you require numbers K-101 through K-250, please contact Customer Service
How to order	No special instructions are needed No extra charge	You must clearly specify "LL Series Locks" on your purchase order No extra charge	You must clearly specify "Haworth SL Series Locks" on your purchase order No extra charge	You must clearly specify "Haworth SL Series Locks" on your purchase order No extra charge	You must clearly specify "LL Series Locks" on your purchase order No extra charge	When ordering the product, no need for special ordering instructions; GO products ship as standard with UM locks You must also order K Series cores and keys separately, either random or with specified key codes No extra charge
Key # range	226 to 425 (408 & 412 not available)	226 to 425 (408 & 412 not available)	1 to 300	N/A	N/A	1 to 250
When shipped....	UM core and key are randomly assigned	LL core and key are randomly assigned	SL core and key are randomly assigned	SL core and key are randomly assigned	LL core and key are randomly assigned	Products are shipped with UM Series lock housing, cores and keys
Key alike service available? (cores and keys will ship separately)	Yes, no charge Specify the desired key sequence on your PO, or specify "random"	Yes, no charge Specify the desired key sequence on your PO, or specify "random"	Yes, no charge Specify the desired key sequence on your PO, or specify "random"	No	No	Yes, no charge Specify the desired key sequence on your PO, or specify "random"
At installation....	No extra steps are needed	No extra steps are needed	No extra steps are needed	Remove and dispose of the SL cores and keys, then replace with ML cores and keys	Remove and dispose of the LL cores and keys, then replace with HW cores and keys	Remove and dispose of the UM Series cores and keys, then replace with K Series cores and keys

Key-Alike Order Form



Type or write in your requests. If you have typed in the form, save and email as an attachment to goorders@greatopenings.com. If you have filled out form by hand, please scan and email.

Date _____ Order Entry # _____
 PO# _____ Notes _____

CUSTOMER INFORMATION

Company _____
 Contact Name _____
 Address _____
 City _____ State _____ Zip _____

SHIPPING INFORMATION

Company _____
 Address _____
 City _____ State _____ Zip _____

CORE KEY UM LL Knoll SL Quantity _____

KEYED ALIKE

_____ Sets of _____ keyed alike	_____ Sets of _____ keyed alike
_____ Sets of _____ keyed alike	_____ Sets of _____ keyed alike
_____ Sets of _____ keyed alike	_____ Sets of _____ keyed alike
_____ Sets of _____ keyed alike	_____ Sets of _____ keyed alike
_____ Sets of _____ keyed alike	_____ Sets of _____ keyed alike

Key-Alike Process and Charges:

- Your key-alike request can be ordered on the original purchase order or under separate cover.
- Key-alike requests for the UM, SL, LL and K Series locks are processed at no charge as long as the quantity of key/core sets match the quantity of cabinets.
- When including the UM, SL, and LL Series locks, products will be shipped with randomly assigned cores/keys. Your key-alike requests for all lock series will be shipped separately and labeled to allow for easy change-out in the field, after the product is installed.
- A core-removal key is provided at no charge with each key-alike request.
- Additional keys, cores, master keys, and core keys may be purchased separately. The cost is \$6 net per item, plus \$20 net for shipping costs.

When ordering products to be keyed-alike, include this Key Order Form with your purchase order.

TAGGED AND LABELED KEY SETS

Line	Type	Core Number	Quantity	Tagging Information
1				
2				
3				
4				
5				
6				
7				
8				
9				
10				
11				
12				
13				
14				
15				

This guide provides specific information to keep your Great Openings and Sparkeology products like new. With proper care, you can expect years of trouble-free use.

Cleaning Painted Metal

1. Apply a small amount of nonabrasive cleaner such as Simple Green®, Windex®, or 409®, using a paper towel or a clean, dry, lint-free microfiber cloth.
2. Rub gently to remove dirt.
3. Wipe clean using a new paper towel or cloth.

Cleaning Laminate

1. Apply a vinegar-and-water solution to a paper towel or a clean, lint-free microfiber cloth.
2. Gently wipe the surface to remove any surface dust. Caution: do not use furniture polish that contains waxes and oils on laminate surfaces. Do not use bleached-based cleaners on laminate as it may discolor. Do not use hard bristle brushes that may scratch the surface.
3. To spot clean laminate, use a mild soap-and-water solution or Windex®.
4. Rub the soiled area in the direction of the grain. If no grain is present, rub in a circular motion.

Cleaning Fabric

1. Regularly clean your fabric by vacuuming or light brushing.
2. Always check the fabric-specific cleaning instructions before deciding which cleaning product to use.
3. Test the cleaning product in an inconspicuous area first to guard against color bleeding or fabric shrinkage.

Cleaning Acrylic Screens and Resin Tops

1. Use mild soap-and-water, applied with a dry lint-free cloth.
2. Wipe clean to remove soap and moisture residue.

PERSONAL STORAGE AND TRACE PEDESTAL SPECIFICATIONS



Basic Construction

- All Great Openings products meet or exceed applicable ANSI-BIFMA standards for durability and safety
- Welded steel frame construction and formed channels ensure strength in key areas
- Top and side channels are 18-21 gauge cold rolled steel
- Outer panels and drawer bins are 22 gauge steel, drawer fronts are 20 gauge steel
- Weight limits of 200 lbs for mobile pedestals and cushion mobile storage
- Black plastic casters are 37 mm, 2 locking and 2 non-locking, installed in the field
- Translucent casters are 50mm, all four casters are non-locking, installed in the field
- Cabinet heights listed include black plastic 37mm casters
- Four leveling glides with 1-5/8" adjustment ensure proper alignment and operation
- Leveling glides are not interchangeable with casters
- The front-facing kick plate on Trace freestanding pedestals is 3.25" high

Features

- Drawer fronts are mechanically fastened and removable to maximize design flexibility
- All drawers include full extension, steel ball bearing slides
- Slides include anti-rebound and quick disconnect features
- Drawer fronts include rubber bumpers for quiet operation
- Drawers can accommodate letter, legal, and ledger filing. Legal and ledger filing require a file drawer divider, sold separately

Options and Accessories

- All options and accessories are sold separately or are available as an upgrade
- Box drawer dividers snap into position and remain in place
- File drawer dividers snap into position to accommodate side-to-side filing
- Pencil trays include four compartments and sit on top of the sides of the box or file drawer bin
- Laminate drawer fronts may be specified. See the Specification Guide for details
- Polyethylene drawer front fillers increase sound absorption
- Individually locking drawers, either keyed or electronic

Lock System

- All Great Openings products include randomly-assigned UM Series locks
- UM locks are black-faced, master-keyed, and core-removable
- Locks may be keyed-alike in the field
- Other key series are available, including Haworth SL, bright nickel LL, and Knoll K. See the Specification Guide for details and how to order
- Pedestals may be ordered to include individually locking security drawers. See the Pedestal Accessory section for details

Counterweights

- Mobile Pedestals, Freestanding Pedestals, and Mobile FileCenters include factory installed counterweight
- Counterweights are not necessary for work surface supporting pedestals or hanging pedestals

Load Capacity

- Pencil drawer: 50 lbs
- Box drawer: 50 lbs
- File drawer: 70 lbs
- Slim bottom drawers: 70 lbs

Trace Pedestal File Inside Dimensions

(in inches)

	Inner Height	Inner Width	Inner Depth
Pedestal 17-7/8" deep			
pencil drawer	1.75"	12.125"	15.2"
box drawer	4.5"	12.125"	15.2"
file drawer	9.5"	12.125"	15.2"
Pedestal 18-7/8" deep			
pencil drawer	1.75"	12.125"	15.2"
box drawer	4.5"	12.125"	15.2"
file drawer	9.5"	12.125"	15.2"
Pedestal 21-7/8" deep			
pencil drawer	1.75"	12.125"	18.25"
box drawer	4.5"	12.125"	18.25"
file drawer	9.5"	12.125"	18.25"
Pedestal 27-7/8" deep			
pencil drawer	1.75"	12.125"	24.25"
box drawer	4.5"	12.125"	24.25"
file drawer	9.5"	12.125"	24.25"
Slim			
concealed drawer	1.75"	9.5"	15.2"
bottom drawer	11.0"	9.75"	15.2"
Molly			
box drawer	4.5"	12.125"	15.2"
file drawer	9.5"	12.125"	15.2"
open shelf/cupboard	17.2"	13.8"	17.3"
Mobile FileCenter			
box drawer	4.5"	12.125"	15.2"
file drawer	9.5"	12.125"	15.2"
Personal Drawer			
personal drawer	2.0"	18.0"	12.2"

Marty



Nano E-lock

- All Great Openings products meet or exceed applicable ANSI-BIFMA standards for durability and safety
- 14 gauge steel frame and 12 gauge steel door, available in 72 standard colors plus custom powder coated finishes
- Laminate shelf (TFL) in white, grey or black
- Detachable hook for hanging bags
- Marty's touch-latch door is available non-locking for easy access, with UM series lock or Nano E-lock.

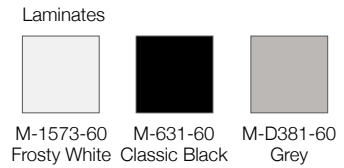
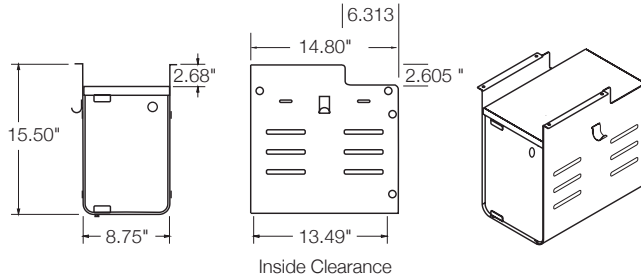

Description	H	D	W	Pkg Wt	Pkg Cube	Part #	Metal Color	Laminate	List Price
Marty Right Hinge	15"	14.80"	8.75"	22 Lb	2.5	HAN1513RH	?	?	\$772
Marty Right Hinge, Locking	15"	14.80"	8.75"	22 Lb	2.5	HNU1513RH	?	?	\$883
Marty Right Hinge, Nano E-lock	15"	14.80"	8.75"	22 Lb	2.5	HWE1513RH	?	?	\$1,166
Marty Left Hinge	15"	14.80"	8.75"	22 Lb	2.5	HAN1513LH	?	?	\$772
Marty Left Hinge, Locking	15"	14.80"	8.75"	22 Lb	2.5	HNU1513LH	?	?	\$883
Marty Left Hinge, Nano E-lock	15"	14.80"	8.75"	22 Lb	2.5	HWE1513LH	?	?	\$1,166

PERSONAL STORAGE

SIN 33721



Slim

- Bottom drawer may be specified as single-sided (left or right) or two-sided
- A two-sided drawer includes file bars to accommodate letter or legal hanging files
- A concealed top drawer is accessible when bottom drawer is open
- Cushion is 1" foam
- Linear yardage required for COM fabric (20 units or fewer): Slim - 3/4 yard
- Unless otherwise specified, the fabric grain on cushions will be applied "front-to-back"
- To specify an electronic lock instead of keyed lock, add an "E" after the "U" of the part number and add \$460 to the list price
- Includes black 37mm casters (2) locking and (2) non-locking
- A 5th caster is located under the bottom drawer
- Caster height allows for 1.792" clearance

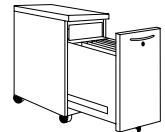

two-sided

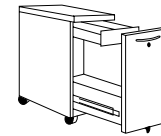

One-sided drawer, access from left side



One-sided drawer, access from right side

SLIM XLT

- 75mm black casters (2L/2NL) integrated into outrigger base for added stability and higher clearance
- Ergonomic, three-stage telescoping handle
- Rear storage bag with one full-length and one half-length pocket for laptop and accessories
- Self closing slides keep drawer closed during travel

H	D	W	Description	Top Option	Drawer access from side	Pkg Wt	Pkg Cube	Part #	Front	Part #	Metal Color	Fabric #	GR 1 Price	GR 2 Price	GR 3 Price	GR 4 Price	GR 5 Price	COM Price
20	18-7/8	12	one-sided drawer	metal	left	41lb	3.8 ft	SLU	?	5638	?	n/a	\$862	n/a	n/a	n/a	n/a	n/a
20	18-7/8	12	one-sided drawer	metal	right	41 lb	3.8 ft	SRU	?	5638	?	n/a	\$862	n/a	n/a	n/a	n/a	n/a
20	18-7/8	12	two-sided drw. & file bars	metal	n/a	41 lb	3.8 ft	STU	?	5640	?	n/a	\$892	n/a	n/a	n/a	n/a	n/a
21	18-7/8	12	one-sided drawer	cushion	left	49 lb	3.8 ft	SLU	?	5638C	?	?	\$1,084	\$1,196	\$1,240	\$1,285	\$1,322	\$1,079
21	18-7/8	12	one-sided drawer	cushion	right	49 lb	3.8 ft	SRU	?	5638C	?	?	\$1,084	\$1,196	\$1,240	\$1,285	\$1,322	\$1,079
21	18-7/8	12	two-sided drw. & file bars	cushion	n/a	49 lb	3.8 ft	STU	?	5640C	?	?	\$1,115	\$1,226	\$1,272	\$1,314	\$1,350	\$1,110
22-1/2	21	14	XLT one-sided drawer	cushion	left	54 lb	3.8 ft	SLU	?	5650C	?	?	\$1,386	\$1,496	\$1,541	\$1,586	\$1,623	\$1,381
22-1/2	21	14	XLT one-sided drawer	cushion	right	54 lb	3.8 ft	SRU	?	5650C	?	?	\$1,386	\$1,496	\$1,541	\$1,586	\$1,623	\$1,381
22-1/2	21	14	XLT two-sided drw. & file bars	cushion	n/a	54 lb	3.8 ft	STU	?	5650C	?	?	\$1,425	\$1,533	\$1,576	\$1,621	\$1,658	\$1,420

Available Fronts | A B D F H J K L N P Q | S

PERSONAL STORAGE

SIN 33721

Molly



- 1-1/2" cushion is factory-installed with screws
- Linear yardage required for COM fabric (20 units or fewer): Molly - 1 yard
- Unless otherwise specified, the fabric grain on cushions will be applied "front-to-back"
- Box/File drawer may be specified on either left or right side
- Includes either open shelves or hinged door
- Hinges are always oriented on the outside of the cabinet
- Electronic lock is not available
- Includes black 37mm casters (2) locking and (2) non-locking
- A 5th caster is located under the bottom drawer

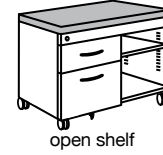

H	D	W	Description	Drawer/ Location	Pkg Wt	Pkg Cube	Part #	Front	Part #	Metal Color	Fabric #	Lam/ Edge #	GR 1 Price	GR 2 Price	GR 3 Price	GR 4 Price	GR 5 Price	COM Price
22-3/8	18-1/4	30-1/2	cup. dr./met. top	left	96.5 lb	12.2 ft	FL	?	L4G 6T	?	n/a	n/a	\$1,844	n/a	n/a	n/a	n/a	n/a
22-3/8	18-1/4	30-1/2	cup. dr./met. top	right	96.5 lb	12.2 ft	FR	?	L4T 9T	?	n/a	n/a	\$1,844	n/a	n/a	n/a	n/a	n/a
22-3/8	18-1/4	30-1/2	open sh./met. top	left	92.5 lb	12.2 ft	FL	?	L4U 2T	?	n/a	n/a	\$1,611	n/a	n/a	n/a	n/a	n/a
22-3/8	18-1/4	30-1/2	open sh./met. top	right	92.5 lb	12.2 ft	FR	?	L4U 1T	?	n/a	n/a	\$1,611	n/a	n/a	n/a	n/a	n/a
22-3/8	18-1/4	30-1/2	cup. dr./lam. top	left	98.5 lb	12.2 ft	FL	?	L4 G6	?	n/a	?	\$2,104	n/a	n/a	n/a	n/a	n/a
22-3/8	18-1/4	30-1/2	cup. dr./lam. top	right	98.5 lb	12.2 ft	FR	?	L4 T9	?	n/a	?	\$2,104	n/a	n/a	n/a	n/a	n/a
22-3/8	18-1/4	30-1/2	open sh./lam. top	left	94.5 lb	12.2 ft	FL	?	L4 U2	?	n/a	?	\$1,981	n/a	n/a	n/a	n/a	n/a
22-3/8	18-1/4	30-1/2	open sh./lam. top	right	94.5 lb	12.2 ft	FR	?	L4 U1	?	n/a	?	\$1,981	n/a	n/a	n/a	n/a	n/a
22-5/8	18-1/4	30-1/2	cup. dr./cushion	left	101.5 lb	12.4 ft	FL	?	L4G 6C	?	?	n/a	\$2,152	\$2,331	\$2,403	\$2,475	\$2,535	\$2,147
22-5/8	18-1/4	30-1/2	cup. dr./cushion	right	101.5 lb	12.4 ft	FR	?	L4T 9C	?	?	n/a	\$2,152	\$2,331	\$2,403	\$2,475	\$2,535	\$2,147
22-5/8	18-1/4	30-1/2	open sh./cushion	left	97.5 lb	12.4 ft	FL	?	L4U 2C	?	?	n/a	\$2,027	\$2,208	\$2,278	\$2,353	\$2,411	\$2,022
22-5/8	18-1/4	30-1/2	open sh./cushion	right	97.5 lb	12.4 ft	FR	?	L4U 1C	?	?	n/a	\$2,027	\$2,208	\$2,278	\$2,353	\$2,411	\$2,022

Available Fronts | A Q | S

Yogi

- All Great Openings products meet or exceed applicable ANSI-BIFMA standards for durability and safety
- 14 gauge steel frame, available in 72 standard colors and custom powder coat finishes
- Dual Durometer 75mm black/grey locking casters (2L/2NL)
- Black laminate shelves include felt liners

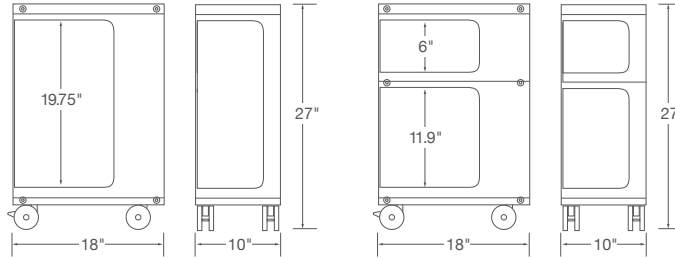

Description	H	D	W	Pkg Wt	Pkg Cube	Part #	Metal Color	List Price
Yogi - Left Facing - Single Bin	27	18	10	27 lb	3.93 ft	LUND1020	?	\$1,092
Yogi - Right Facing - Single Bin	27	18	10	27 lb	3.93 ft	RUND1020	?	\$1,092
Yogi - Left Facing - Double Bin	27	18	10	30 lb	3.93 ft	LUND2020	?	\$1,215
Yogi - Right Facing - Double Bin	27	18	10	30 lb	3.93 ft	RUND2020	?	\$1,215

M3 Cart

- Grey PET felt tray liners

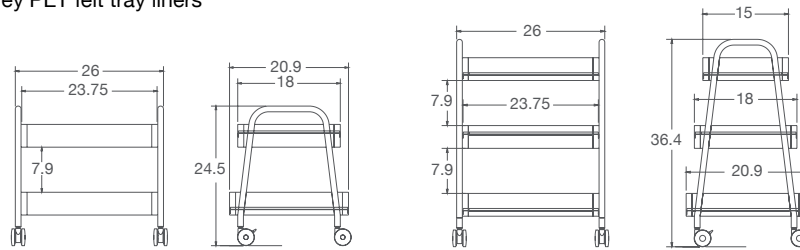

Description	H	D	W	Pkg Wt	Pkg Cube	Part #	Metal Color	List Price
M3 Mini Cart	24-1/2	20.9	26	62 lb	13 ft	MIM2426	?	\$1,422
M3 Team Cart	36.4	20.9	26	76 lb	19 ft	MIM3626	?	\$1,789

GOcart

- Metal case construction
- Black plastic casters are 37 mm, 2 locking and 2 non-locking, installed in the field
- Black plastic 5th wheel supports full extension lower drawer
- Front available in standard painted metal with choice of integrated side access finger pull, satin nickel loop pull or satin nickel bar pull
- Drawer fronts include rubber bumpers for quiet operation
- Includes UM series locks, keyed alike, black-faced, master-keyed, and core-removable (may be keyed-alike in the field)
- Other available key series include SL and LL bright nickel
- Cushion option available upon request. Call for quote

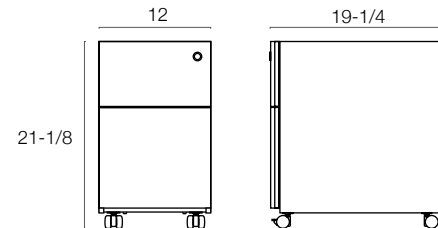
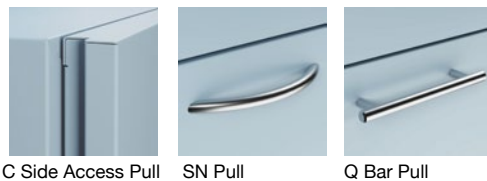

H	D	W	Pkg Wt	Pkg Cube	Part #	Front	Part #	Metal Color	Price
21-1/8	19-1/4	12	49 lb	3.8 ft	SL	?	1431	?	\$740

TRACE PEDESTALS

SIN 33721

TRACE Mobile FileCenter



- Choose from cushion top or metal top
- 1-1/2" cushion is factory-installed with screws
- Linear yardage required for COM fabric (20 units or fewer): 1 yard
- Black casters offered in 37mm (1.5") and 75mm (3") diameters
- 5th wheels on file drawer to prevent tipping
- Cabinet heights listed include casters
- Weight limits of 200 lbs
- Electronic lock is not available

H	D	W	Description	Caster Style	Pkg Wt	Pkg Cube	Part #	Front	Part #	Metal Color	Fabric #	GR 1 Price	GR 2 Price	GR 3 Price	GR 4 Price	GR 5 Price	COM Price
22-5/8	18-1/4	30-1/2	cushion top	37mm black	109 lb	12.2 ft	FL	?	0107-5W-C	?	?	\$2,183	\$2,358	\$2,422	\$3,097	\$3,183	\$2,178
24-1/4	18-1/4	30-1/2	cushion top	75mm black	109 lb	12.2 ft	FL	?	0108-5W-C	?	?	\$2,234	\$2,409	\$2,471	\$3,148	\$3,232	\$2,229

H	D	W	Description	Caster Style	Pkg Wt	Pkg Cube	Part #	Front	Part #	Metal Color	Fabric #	Price
21-3/4	18-1/4	30-1/2	metal top	37mm black	109 lb	12.2 ft	FL	?	0107-5W-T	?	n/a	\$1,933
23-3/8	18-1/4	30-1/2	metal top	75mm black	109 lb	12.2 ft	FL	?	0108-5W-T	?	n/a	\$1,984

Available Fronts | A | F | H | P | Q | S

TRACE Cushion Mobile Pedestal



- 1-1/2" cushion is factory-installed with screws
- 1 linear yard required for COM fabric (20 units or fewer)
- Unless otherwise specified, the fabric grain on cushions will be applied "front-to-back"
- When any loop pull is designated, a matching loop pull is included on the lock strip
- When any non-loop pull is designated, a Satin Nickel loop pull is included on the lock strip
- To specify an electronic lock instead of keyed lock, add an "E" after the "U" of the part number and add \$460 to the list price
- For COM fabric ordering instructions, see the Specification Guide
- Includes black 37mm casters (2) locking and (2) non-locking
- Box/File pedestal available with fifth wheel and no counterweight

H	D	W	Drawer Options	Pkg Wt	Pkg Cube	Part #	Front	Part #	Metal Color	Fabric #	Part #	GR 1 Price	GR 2 Price	GR 3 Price	GR 4 Price	GR 5 Price	COM Price
22-5/8	18-7/8	15-1/4	box/file	60 lb	5.9 ft	U	?	1403	?	?	N	\$1,065	\$1,150	\$1,185	\$1,229	\$1,249	\$1,060
22-5/8	18-7/8	15-1/4	box/file with 5th wheel	44 lb	5.9 ft	U	?	1403-37W	?	?	N	\$1,052	\$1,136	\$1,173	\$1,208	\$1,236	\$1,047
22-5/8	21-7/8	15-1/4	box/file	70 lb	6.6 ft	U	?	1503	?	?	N	\$1,082	\$1,169	\$1,206	\$1,240	\$1,266	\$1,077
22-5/8	21-7/8	15-1/4	box/file with 5th wheel	54 lb	6.6 ft	U	?	1503-37W	?	?	N	\$1,069	\$1,156	\$1,191	\$1,226	\$1,254	\$1,064
25-1/2	18-7/8	15-1/4	pencil/box/file	70 lb	6.1 ft	U	?	1719	?	?	N	\$1,274	\$1,358	\$1,394	\$1,429	\$1,457	\$1,269
25-1/2	21-7/8	15-1/4	pencil/box/file	75 lb	6.8 ft	U	?	1819	?	?	N	\$1,296	\$1,381	\$1,418	\$1,453	\$1,479	\$1,291



box/file



box/file 5th wheel



pencil/box/file

Available Fronts	box and file drawers	A	B	D	F	H	I	N	P	Q	S
	pencil drawers	A	B	D	F	H	I	N	P	Q	S

TRACE PEDESTALS

SIN 33721

TRACE Mobile Pedestal

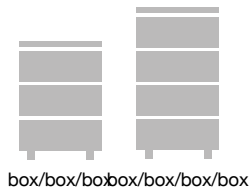
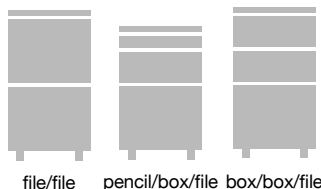
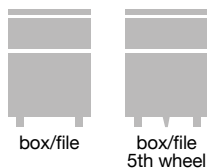

- To add a Satin Nickel loop pull on the lock strip (as shown on the Cushion Mobile Pedestal), add an "N" as a suffix to the part number and \$53 to the list price
- Mobile pedestals are not to be used as a seat, a cushion may not be added to this mobile pedestal
- To specify an electronic lock instead of keyed lock, substitute an "E" for the second letter "L" of the part number and add \$460 to the list price
- Includes black 37mm casters (2) locking and (2) non-locking

H	D	W	Drawer Options	Pkg Wt	Pkg Cube	Part #	Front	Part #	Metal Color	Price
26-7/8	18-7/8	15-1/4	file/file	60 lb	7.0 ft	EL	?	2009	?	\$823
26-7/8	18-7/8	15-1/4	box/box/file	64 lb	7.0 ft	EL	?	2011	?	\$911
26-7/8	18-7/8	15-1/4	box/box/box/box	60 lb	7.0 ft	EL	?	2010	?	\$955
26-7/8	21-7/8	15-1/4	file/file	68 lb	8.0 ft	EL	?	2109	?	\$835
26-7/8	21-7/8	15-1/4	box/box/file	73 lb	8.0 ft	EL	?	2111	?	\$917
26-7/8	21-7/8	15-1/4	box/box/box/box	68 lb	8.0 ft	EL	?	2110	?	\$982
26-7/8	27-7/8	15-1/4	file/file	79 lb	10.0 ft	EL	?	2209	?	\$930
26-7/8	27-7/8	15-1/4	box/box/file	85 lb	10.0 ft	EL	?	2211	?	\$981
26-7/8	27-7/8	15-1/4	box/box/box/box	79 lb	10.0 ft	EL	?	2210	?	\$1,027
24	18-7/8	15-1/4	pencil/box/file	73 lb	7.8 ft	EL	?	1719	?	\$992
24	21-7/8	15-1/4	pencil/box/file	73 lb	7.8 ft	EL	?	1819	?	\$1,028
24	27-7/8	15-1/4	pencil/box/file	73 lb	7.8 ft	EL	?	1919	?	\$1,051
21-1/8	18-7/8	15-1/4	box/file	54 lb	5.6 ft	EL	?	1403	?	\$769
21-1/8	18-7/8	15-1/4	box/file with 5th wheel	38 lb	5.6 ft	EL	?	1403-37W	?	\$754
21-1/8	18-7/8	15-1/4	box/box/box	54 lb	5.6 ft	EL	?	1404	?	\$857
21-1/8	21-7/8	15-1/4	box/file	63 lb	6.3 ft	EL	?	1503	?	\$786
21-1/8	21-7/8	15-1/4	box/file with 5th wheel	47 lb	6.3 ft	EL	?	1503-37W	?	\$772
21-1/8	21-7/8	15-1/4	box/box/box	63 lb	6.3 ft	EL	?	1504	?	\$867
21-1/8	27-7/8	15-1/4	box/file	73 lb	7.8 ft	EL	?	1603	?	\$853
21-1/8	27-7/8	15-1/4	box/file with 5th wheel	57 lb	7.8 ft	EL	?	1603-37W	?	\$839

Available Fronts	box and file drawers	A	B	D	F	H	I	N	P	Q	S
	pencil drawers	A	B	D	F	H	I	N	P	Q	S

Spec Guide Personal Storage Pedestals Lateralis Collab. Islands Lockers Lam Lockers Towers Storage Cabinets Bookcases Cayenne Ht Adj Tables Trace Desk Desk Accs Sparkology Terms/Conds

TRACE Designer Pedestal

- Metal case construction
- Front available in standard painted metal with integrated side access finger pull or TFL laminate front with black plastic recessed pull
- TFL laminate fronts in black, gray or white
Other laminates available – call for a quote
- Drawer fronts are mechanically fastened and removable to maximize design flexibility
- Slides include anti-rebound and quick disconnect features
- Drawer fronts include rubber bumpers for quiet operation
- Drawers can accommodate letter, legal, and ledger filing. Legal and ledger filing require a file drawer divider, sold separately



Metal Front



Laminate Front



H	D	W	Drawer Options	Pkg Wt	Pkg Cube	Part #	Metal Color	Laminate	Price
21-1/8	19-1/4	15-1/4	metal front – box/file	68 lb	7.6 ft	DLC1403	?	na	\$706
21-1/8	19-1/4	15-1/4	laminate front – box/file	68 lb	7.6 ft	DLC1403	?	?	\$897

TRACE Work Surface Supporting Pedestal

- Top channels are exposed, to attach to underside of work surface
- Special 27" and 24-3/4" heights accommodate low profile work surfaces
- Counterweight not included; a Work Surface Supporting Pedestal cannot be used in a freestanding application
- To specify an electronic lock instead of keyed lock, substitute an "E" for the second letter "L" of the part number and add \$460 to the list price

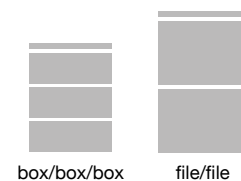
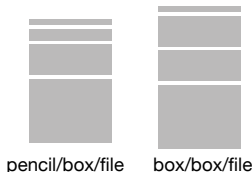

H	D	W	Drawer Options	Pkg Wt	Pkg Cube	Part #	Front	Part #	Metal Color	Price
27-3/4	17-7/8	15-1/4	file/file	51 lb	7.2 ft	EL	?	2909	?	\$779
27-3/4	17-7/8	15-1/4	box/box/file	53 lb	7.2 ft	EL	?	2911	?	\$846
27-3/4	17-7/8	15-1/4	box/box/box/box	56 lb	7.2 ft	EL	?	2910	?	\$865
27-3/4	21-7/8	15-1/4	file/file	56 lb	8.6 ft	EL	?	3009	?	\$786
27-3/4	21-7/8	15-1/4	box/box/file	59 lb	8.6 ft	EL	?	3011	?	\$859
27-3/4	21-7/8	15-1/4	box/box/box/box	56 lb	8.6 ft	EL	?	3010	?	\$902
27-3/4	27-7/8	15-1/4	file/file	67 lb	10.6 ft	EL	?	3109	?	\$894
27-3/4	27-7/8	15-1/4	box/box/file	70 lb	10.6 ft	EL	?	3111	?	\$937
27-3/4	27-7/8	15-1/4	box/box/box/box	67 lb	10.6 ft	EL	?	3110	?	\$973
27	17-7/8	15-1/4	file/file	51 lb	7.2 ft	EL	?	3809	?	\$813
27	17-7/8	15-1/4	box/box/file	53 lb	7.2 ft	EL	?	3811	?	\$889
27	21-7/8	15-1/4	file/file	55 lb	8.4 ft	EL	?	3309	?	\$820
27	21-7/8	15-1/4	box/box/file	58 lb	8.4 ft	EL	?	3311	?	\$906
24-3/4	21-7/8	15-1/4	pencil/box/file	56 lb	8.2 ft	EL	?	2719	?	\$948
24-3/4	27-7/8	15-1/4	pencil/box/file	67 lb	10.2 ft	EL	?	2819	?	\$1,031

Available Fronts	box and file drawers	A	B	D	F	H	I	N	P	Q	S
	pencil drawers	A	B	D	F	H	I	N	P	Q	S

TRACE Hanging Pedestal



- Hangs from underneath a work surface
- Includes quick-mount attachment, for easy installation
- To specify an electronic lock instead of keyed lock, substitute an “E” for the second letter “L” of the part number and add \$460 to the list price

H	D	W	Drawer Options	Pkg Wt	Pkg Cube	Part #	Front	Part #	Metal Color	Price
13-5/8	21-7/8	15-1/4	box/box	33 lb	4.1 ft	EL	?	3623	?	\$628
19-3/8	17-7/8	15-1/4	box/file	40 lb	5.3 ft	EL	?	0503	?	\$619
19-3/8	17-7/8	15-1/4	box/box/box	43 lb	5.3 ft	EL	?	0504	?	\$891
19-3/8	21-7/8	15-1/4	box/file	43 lb	5.3 ft	EL	?	0603	?	\$638
19-3/8	21-7/8	15-1/4	box/box/box	48 lb	6.4 ft	EL	?	0604	?	\$902
25	21-7/8	15-1/4	box/box/file	52 lb	8.6 ft	EL	?	1211	?	\$924
25	21-7/8	15-1/4	file/file	52 lb	8.6 ft	EL	?	1209	?	\$849

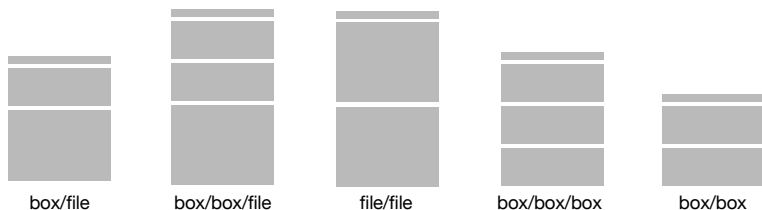

Available Fronts | A | B | D | F | H | I | N | P | Q | S

TRACE Freestanding Pedestal



- To specify an electronic lock instead of keyed lock, substitute an “E” for the second letter “L” of the part number and add \$460 to the list price

H	D	W	Drawer Options	Pkg Wt	Pkg Cube	Part #	Front	Part #	Metal Color	Price
27-3/4	18-7/8	15-1/4	file/file	68 lb	7.6 ft	EL	?	6109	?	\$796
27-3/4	18-7/8	15-1/4	box/box/file	70 lb	7.6 ft	EL	?	6111	?	\$866
27-3/4	18-7/8	15-1/4	box/box/box/box	69 lb	7.6 ft	EL	?	6110	?	\$929
27-3/4	21-7/8	15-1/4	file/file	74 lb	8.6 ft	EL	?	5109	?	\$818
27-3/4	21-7/8	15-1/4	box/box/file	76 lb	8.6 ft	EL	?	5111	?	\$891
27-3/4	21-7/8	15-1/4	box/box/box/box	75 lb	8.6 ft	EL	?	5110	?	\$953
27-3/4	27-7/8	15-1/4	file/file	83 lb	10.6 ft	EL	?	5309	?	\$918
27-3/4	27-7/8	15-1/4	box/box/file	86 lb	10.6 ft	EL	?	5311	?	\$999
27-3/4	27-7/8	15-1/4	box/box/box/box	87 lb	10.6 ft	EL	?	5310	?	\$1,061
24-7/8	18-7/8	15-1/4	pencil/box/file	53 lb	8 ft	EL	?	6219	?	\$1,126
24-7/8	21-7/8	15-1/4	pencil/box/file	55 lb	8.3 ft	EL	?	4119	?	\$1,158
24-7/8	27-7/8	15-1/4	pencil/box/file	67 lb	8.8 ft	EL	?	4219	?	\$1,239

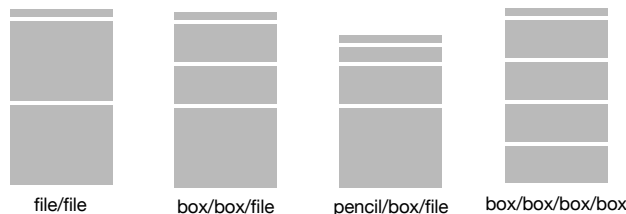

Available Fronts | box and file drawers | A | B | D | F | H | I | N | P | Q | S |
 pencil drawers | A | ~~B~~ | ~~D~~ | ~~F~~ | ~~H~~ | ~~I~~ | N | ~~P~~ | Q | S

**Pedestal Accessories
(Factory Installed)**



file drawer divider

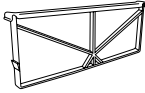

box drawer divider

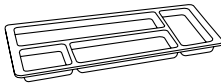

pencil tray

- Order one of these packages to be installed in the pedestal in the factory
- Black plastic pencil tray includes 4 compartments and sits on top of drawer bin sides
- Black plastic drawer dividers snap in place. The drawer divider may also be used as a file conversion bar for side-to-side filing, and as a file compressor
- Accessory package prices will be added to the standard pedestal prices

Description	Options	Part #	Price
file/file pedestals will include two 12" drawer dividers	file/file	add "A" as a suffix to the part number	\$38
box/box/file will include two 6" drawer dividers, one 12" drawer divider, and one pencil tray	box/box/file	add "A" as a suffix to the part number	\$68
box/file will include one 6" divider, one 12" divider and one pencil tray	box/file	add "A" as a suffix to the part number	\$56
pedestal will include one pencil tray	any	add "P" as a suffix to the part number	\$21

**Pedestal Accessories
Sold Separately**

- Individual pedestal accessories, described above, are packaged and sold separately

Description	Pkg Weight	Pkg Cube	Part #	Price
single pencil tray	.5 lb	4.3	VMEX 000 29-1	\$21
single box drawer divider	.25 lb	1.7	ECOX 1070-1	\$15
single file drawer divider	.75 lb	4.3	ECOX 1071-1	\$21

**Security Pedestal
Upgrade**



- Pedestals that include box or file drawers may be converted to a security unit by adding a lock to each drawer and a security shelf between each drawer
- This (non-UM) double-bit security lock is conical in shape and chrome plated. Please call our Customer Service for lead-time information
- Security pedestal upgrade prices will be added to the standard pedestal price

Description	Options	Part #	Price
security pedestal upgrade	file/file	Add "EY" as a suffix to the part number	\$305
	box/file	Add "EY" as a suffix to the part number	\$332
	box/box/file	Add "EY" as a suffix to the part number	\$384

Available Fronts | A B | D | F H I | N P | Q | S

**Drawer Front Filler
-Pedestals**

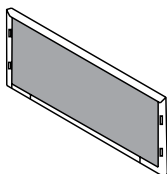

Inside View

- Pedestals with box or file drawers may be upgraded to include a closed cell polyethylene filler piece that adheres to the inside of the drawer front for improved sound dampening. (3" pencil drawers are enclosed as standard with a formed metal piece.)
- Drawer Front Filler upgrades, priced per drawer, will be added to the product list price

Description	Options	Part #	Price/Drw
drawer front filler	price per drawer	Add "U" as a suffix to the part number	\$21

Available Fronts | A | B | D | F | H | I | N | P | Q | S



Basic Construction

- Trace lateral files feature horizontal lines and full-width fronts consistent with all other Trace products
- All Great Openings products meet or exceed applicable ANSI-BIFMA standards for durability and safety
- Welded steel frame construction and formed channels ensure strength in key areas
- Reinforced vertical and horizontal channels ensure dimensional stability
- Top and side channels are 20 gauge cold rolled steel. Fronts, tops, outer panels are 20 and 22 gauge. Drawer bins and shelves are 18 and 20 gauge
- The lock strip on 4-high and 5-high laterals is located above the fourth drawer. In 6-high laterals, the lock strip is located above the fifth drawer
- Four leveling glides with 1-1/4" adjustment ensure proper alignment and operation
- The front-facing kick plate on Trace lateral files is 3.25" high

Features

- The top opening of 5-high and 6-high Trace laterals features an over-the-top flipper door with 13-1/4" inside clear height that will accommodate standard height binder storage
- All drawers and roll-out shelves include full extension steel ball-bearing slides with anti-rebound features to ensure smooth operation
- Trace lateral file metal and laminate tops are sized to be flush with the sides of the cabinet, so that files installed side-to-side will have no gaps between
- Drawers include full-height side panels
- Two file bars are included in each drawer, for side-to-side filing. File conversion bars for front-to-back filing are sold separately
- Drawer bins will accommodate A4, Letter, and Legal size filing

Options and Accessories

- All options and accessories are sold separately or are available as an upgrade
- Laminate drawer fronts may be specified. See the Specification Guide for details
- Common laminate tops
- Polyethylene drawer front fillers increase sound absorption
- Individually locking drawers, either keyed or electronic
- File conversion bars for front-to-back filing
- Magnetic shelf dividers
- Magnetic label
- Magnetic drawer dividers for lateral box drawers

Lock System

- All Great Openings products include randomly-assigned UM Series locks
- UM locks are black-faced, master-keyed, and core-removable
- Locks may be keyed-alike in the field
- Other key series are available, including Haworth SL, bright nickel LL, and Knoll K. See the Specification Guide for details and how to order

- Trace lateral file locking system captures drawer fronts on both sides
- Trace lateral files may be ordered to include individually locking security drawers

Counterweights & Interlock

- The safety interlock mechanism is integrated into the drawer slides, allowing only one drawer to open at a time
- All lateral files with drawers and roll-out shelves used as freestanding cabinets must have counterweight if not ganged together or otherwise anchored
- Counterweights may be factory-installed or purchased separately to be installed in the field

Load Capacity

- Drawer and roll-out shelf load capacity:
 - 30", 36", and 42" wide drawers is 125 lb
- Fixed and adjustable shelf load capacity:
 - 30" shelf: 95 lbs
 - 36" shelf: 116 lbs
 - 42" shelf: 136 lbs
- Lateral file metal top load capacity:
 - 30" wide top: 140 lbs
 - 36" wide top: 168 lbs
 - 42" wide top: 192 lbs

Trace Lateral File Inside Dimensions (in inches)

	Inner Height	Inner Width	Inner Depth
File Drawers (positioned below lock strip)			
30" wide	10.43"	26.7"	16.0"
36" wide	10.43"	32.7"	16.0"
42" wide	10.43"	38.7"	16.0"
File Drawers (positioned below other drawers)			
30" wide	10.75"	26.7"	16.0"
36" wide	10.75"	32.7"	16.0"
42" wide	10.75"	38.7"	16.0"
Top Flipper Door Opening on 5-high Trace Laterals			
30" wide	13"	26.7"	16.0"
36" wide	13"	32.7"	16.0"
42" wide	13"	38.7"	16.0"
Box Drawers (positioned below lock strip)			
30" wide	4.7"	26.7"	16.0"
36" wide	4.7"	32.7"	16.0"
42" wide	4.7"	38.7"	16.0"
Box Drawers (positioned below other drawers)			
30" wide	5.1"	26.7"	16.0"
36" wide	5.1"	32.7"	16.0"
42" wide	5.1"	38.7"	16.0"
Fixed Shelves			
30" wide	12.50"	28.5"	16.0"
36" wide	12.50"	34.5"	16.0"
42" wide	12.50"	40.5"	16.0"

TRACE LATERAL FILES

SIN 33721

TRACE Lateral File



- 5-high and 6-high include top flipper door that stows over-the-top, revealing either a roll-out or fixed shelf
- Flipper compartment features 13-1/4" inside clear height for binder storage
- Counterweight is required if not ganged together or otherwise anchored
- Laminate tops are sold separately for individual laterals and laterals paired side-by-side or back-to-back (see lateral accessory section). Please note that a laminate top may not be placed on top of a Trace lateral that includes a flipper door on the top opening
- Trace lateral files with flipper door on top, when installed in a "built-in" wall situation will require a minimum of 1-1/2" clearance above the cabinet for the flipper door to go up and over the top

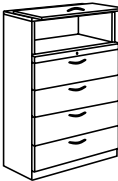
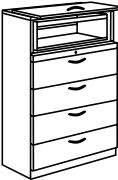

H	D	W	Cabinet Style	Contains	Pkg Wt	Pkg Cube	Part #	Front	Part #	Metal Color	Price
28-3/8	18-1/4	30			98 lb	11.8 ft	RG	?	C301	?	\$1,455
28-3/8	18-1/4	36	2-high	2 drawers	114 lb	14.0 ft	RG	?	C401	?	\$1,556
28-3/8	18-1/4	42			130 lb	16.2 ft	RG	?	C501	?	\$1,710
39-7/8	18-1/4	30			134 lb	16.5 ft	RG	?	C602	?	\$1,968
39-7/8	18-1/4	36	3-high	3 drawers	156 lb	19.6 ft	RG	?	C702	?	\$2,096
39-7/8	18-1/4	42			180 lb	22.7 ft	RG	?	C802	?	\$2,310
51-3/8	18-1/4	30			171 lb	22.0 ft	RG	?	C903	?	\$2,426
51-3/8	18-1/4	36	4-high	4 drawers	198 lb	26.0 ft	RG	?	D103	?	\$2,578
51-3/8	18-1/4	42			225 lb	30.0 ft	RG	?	D203	?	\$2,838
65-7/8	18-1/4	30		4 drawers	207 lb	28.0 ft	RG	?	D304	?	\$3,037
65-7/8	18-1/4	36	5-high	1 top flipper door, rollout shelf	241 lb	33.0 ft	RG	?	D404	?	\$3,229
65-7/8	18-1/4	42			275 lb	38.0 ft	RG	?	D504	?	\$3,551
65-7/8	18-1/4	30		4 drawers	205 lb	28.0 ft	RG	?	D311	?	\$2,931
65-7/8	18-1/4	36	5-high	1 top flipper door, fixed shelf	240 lb	33.0 ft	RG	?	D411	?	\$3,119
65-7/8	18-1/4	42			273 lb	38.0 ft	RG	?	D511	?	\$3,445
77-3/8	18-1/4	30		5 drawers	243 lb	32.6 ft	RG	?	E778	?	\$3,453
77-3/8	18-1/4	36	6-high	1 top flipper door, rollout shelf	283 lb	38.5 ft	RG	?	E878	?	\$3,856
77-3/8	18-1/4	42			325 lb	44.5 ft	RG	?	E978	?	\$4,180
77-3/8	18-1/4	30		5 drawers	239 lb	32.6 ft	RG	?	E7G7	?	\$3,344
77-3/8	18-1/4	36	6-high	1 top flipper door, fixed shelf	279 lb	38.5 ft	RG	?	E8G7	?	\$3,748
77-3/8	18-1/4	42			321 lb	44.5 ft	RG	?	E9G7	?	\$4,073

Available Fronts | A | B |  | F | H |  | P | Q | S

TRACE LATERAL FILES

SIN 33721

TRACE Low Height Lateral File

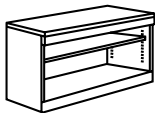

- Trace box/file lateral files require counterweight unless they are ganged back-to-back with another lateral file or otherwise tethered to a permanent structure. Without counterweights, ganging box/file lateral files side-by-side will not ensure stability
- Choosing counterweight for lateral files with box drawers requires special attention. Select the appropriate counterweight by the height of the cabinet, rather than by the number of drawers
- Open shelf lateral files do not need counterweight
- Cushion is 1-1/2" tall, an upholstered board factory-installed with screws
- 3/4 linear yard required for COM fabric (20 units or fewer)
- Unless otherwise specified, the fabric grain on all cushions will run "front-to-back"
- Open shelf unit allows for binder height storage on one shelf. Shelves adjust in 1/2" increments, and counterweight is not necessary

H	D	W	Top	Cabinet Style	Pkg Wt	Pkg Cube	Part #	Front	Part #	Metal Color	Price
22-5/8	18-1/4	30	metal	box/file	97 lb	11.8 ft	RG	?	V3L7	?	\$1,452
22-5/8	18-1/4	36	metal	box/file	115 lb	14.0 ft	RG	?	V4L7	?	\$1,541
22-5/8	18-1/4	42	metal	box/file	135 lb	16.2 ft	RG	?	V5L7	?	\$1,683

H	D	W	Top	Cabinet Style	Pkg Wt	Pkg Cube	Part #	Metal Color	Price
22-5/8	18-1/4	30	metal	box/file	54 lb	7.8 ft	ROS V3M9	?	\$1,154
22-5/8	18-1/4	36	metal	OS lateral 1 adjustable shelf	58 lb	8.1 ft	ROS V4M9	?	\$1,275
22-5/8	18-1/4	42	metal		62 lb	9.3 ft	ROS V5M9	?	\$1,387

H	D	W	Top	Cabinet Style	Wt	Cube	Part #	Front	Part #	Metal Color	Fab #	GR 1 Price	GR 2 Price	GR 3 Price	GR 4 Price	GR 5 Price	COM Price
23-1/2	18-1/4	30	1-1/2-h. cushion	box/ file	90 lb	7.8 fr	RG	?	V3L7C	?	?	\$1,850	\$1,989	\$2,047	\$2,102	\$2,147	\$1,845
23-1/2	18-1/4	36	1-1/2-h. cushion	box/ file	96 lb	8.1 ft	RG	?	V4L7C	?	?	\$1,962	\$2,102	\$2,160	\$2,214	\$2,260	\$1,957
23-1/2	18-1/4	42	1-1/2-h. cushion	box/ file	122 lb	9.3 ft	RG	?	V5L7C	?	?	\$2,145	\$2,285	\$2,342	\$2,398	\$2,443	\$2,140

H	D	W	Top	Cabinet Style	Wt	Cube	Part #	Metal Color	Fab #	GR 1 Price	GR 2 Price	GR 3 Price	GR 4 Price	GR 5 Price	COM Price
23-1/2	18-1/4	30	1-1/2-h. cushion	box/file	57 lb	7.8 ft	ROS V3M9CT	?	?	\$1,559	\$1,700	\$1,757	\$1,813	\$1,858	\$1,554
23-1/2	18-1/4	36	1-1/2-h. cushion	OS lateral 1 adjustable shelf	61 lb	8.1 ft	ROS V4M9CT	?	?	\$1,700	\$1,841	\$1,898	\$1,953	\$1,999	\$1,695
23-1/2	18-1/4	42	1-1/2-h. cushion		65 lb	9.3 ft	ROS V5M9CT	?	?	\$1,855	\$1,996	\$2,053	\$2,110	\$2,153	\$1,850

Available Fronts | A B C D E F G H I J K L M N O P Q | S

Spec Guide Personal Storage Pedestals Lateral Collab. Islands Lockers Lam Lockers Towers Storage Cabinets Bookcases Cayenne Ht Adj Tables Trace Desk Desk Accs Sparkology Terms/Conds

TRACE LATERAL FILES

SIN 33721

TRACE Lateral File with Box Drawers



- All lateral files with drawers used as freestanding cabinets must have counterweight if not ganged together or otherwise anchored
- Choosing counterweight for lateral files with box drawers requires special attention. Select the appropriate counterweight by the height of the cabinet, rather than by the number of drawers

H	D	W	Cabinet Style	Contains	Pkg Wt	Pkg Cube	Part #	Front	Part #	Metal Color	Price
28-3/8	18-1/4	30	2 high	(4) box	113 lb	11.8 ft	RG	?	C307	?	\$2,057
28-3/8	18-1/4	36	2 high	(4) box	132 lb	14.0 ft	RG	?	C407	?	\$2,188
28-3/8	18-1/4	42	2 high	(4) box	151 lb	16.2 ft	RG	?	C507	?	\$2,357
28-3/8	18-1/4	30	2 high	(2) box (1) file	103 lb	11.8 ft	RG	?	C338	?	\$1,687
28-3/8	18-1/4	36	2 high	(2) box (1) file	120 lb	14.0 ft	RG	?	C438	?	\$1,786
28-3/8	18-1/4	42	2 high	(2) box (1) file	137 lb	16.2 ft	RG	?	C538	?	\$1,931
<hr/>											
39-7/8	18-1/4	30	3 high	(6) box	159 lb	16.5 ft	RG	?	C606	?	\$2,634
39-7/8	18-1/4	36	3 high	(6) box	186 lb	19.6 ft	RG	?	C706	?	\$2,809
39-7/8	18-1/4	42	3 high	(6) box	213 lb	22.7 ft	RG	?	C806	?	\$3,036
39-7/8	18-1/4	30	3 high	(2) box (2) file	139 lb	16.5 ft	RG	?	C641	?	\$2,263
39-7/8	18-1/4	36	3 high	(2) box (2) file	162 lb	19.6 ft	RG	?	C741	?	\$2,412
39-7/8	18-1/4	42	3 high	(2) box (2) file	185 lb	22.7 ft	RG	?	C841	?	\$2,603
39-7/8	18-1/4	30	3 high	(4) box (1) file	149 lb	16.5 ft	RG	?	C6B6	?	\$2,583
39-7/8	18-1/4	36	3 high	(4) box (1) file	178 lb	19.6 ft	RG	?	C7B6	?	\$2,746
39-7/8	18-1/4	42	3 high	(4) box (1) file	212lb	22.7 ft	RG	?	C8B6	?	\$2,967
<hr/>											
51-3/8	18-1/4	30	4 high	(8) box	206 lb	21.3 ft	RG	?	C905	?	\$3,298
51-3/8	18-1/4	36	4 high	(8) box	240 lb	25.2 ft	RG	?	D105	?	\$3,519
51-3/8	18-1/4	42	4 high	(8) box	274 lb	29.1 ft	RG	?	D205	?	\$3,795
51-3/8	18-1/4	30	4 high	(2) box (3) file	176 lb	21.3 ft	RG	?	C940	?	\$2,770
51-3/8	18-1/4	36	4 high	(2) box (3) file	204 lb	25.2 ft	RG	?	D140	?	\$2,949
51-3/8	18-1/4	42	4 high	(2) box (3) file	232 lb	29.1 ft	RG	?	D240	?	\$3,180

Available Fronts | A Q | S

TRACE LATERAL FILES

SIN 33721

TRACE Individual-Locking Lateral File



top opening does not lock



- High security locking system with a double-bit keyed lock
- Will not key-alike with a standard UM series lock
- Drawer fronts are captured on both sides
- A security pan is included between each drawer
- The standard gang lock, which typically locks all drawers together, is not included
- A safety interlock, which allows for just one drawer to be opened at a time, is included
- Counterweight is required if not ganged together or otherwise anchored
- Contact Customer Service to discuss key series availability and lead time
- To change the keyed lock to an electronic lock, change the "RG" to an "RE" in the first part number and add \$460 list per drawer. Electronic locks may only be specified with an "A: Full Pull" drawer front
- 5-high and 6-high laterals include a non-locking flipper door with fixed shelf in the top opening

H	D	W	Cabinet Style	Contains	Pkg Wt	Pkg Cube	Part #	Front	Part #	Metal Color	Part #	Price
28-3/8	18-1/4	30	2-high		98 lb	11.8 ft	RG	?	C301	?	RY	\$1731
28-3/8	18-1/4	36	2-high	2 drawers	114 lb	14.0 ft	RG	?	C401	?	RY	\$1832
28-3/8	18-1/4	42	2-high		130 lb	16.2 ft	RG	?	C501	?	RY	\$1986
39-7/8	18-1/4	30	3-high		134 lb	16.5 ft	RG	?	C602	?	RY	\$2384
39-7/8	18-1/4	36	3-high	3 drawers	156 lb	19.6 ft	RG	?	C702	?	RY	\$2512
39-7/8	18-1/4	42	3-high		180 lb	22.7 ft	RG	?	C802	?	RY	\$2726
51-3/8	18-1/4	30	4-high		171 lb	22.0 ft	RG	?	C903	?	RY	\$2982
51-3/8	18-1/4	36	4-high	4 drawers	198 lb	26.0 ft	RG	?	D103	?	RY	\$3134
51-3/8	18-1/4	42	4-high		225 lb	30.0 ft	RG	?	D203	?	RY	\$3394
65-7/8	18-1/4	30	5-high	4 drawers	205 lb	28.0 ft	RG	?	D311	?	RY	\$3487
65-7/8	18-1/4	36	5-high	1 top flipper door with fixed shelf	240 lb	33.0 ft	RG	?	D411	?	RY	\$3676
65-7/8	18-1/4	42	5-high		273 lb	38.0 ft	RG	?	D511	?	RY	\$4001
77-3/8	18-1/4	30	6-high	5 drawers	239 lb	32.6 ft	RG	?	E7G7	?	RY	\$3983
77-3/8	18-1/4	36	6-high	1 top flipper door with fixed shelf	279 lb	38.5 ft	RG	?	E8G7	?	RY	\$4387
77-3/8	18-1/4	42	6-high		321 lb	44.5 ft	RG	?	E9G7	?	RY	\$4712

Available Fronts | A | B | F | H | X | P | Q | S

**TRACE
Counterweight
– Factory Installed**

- In order to satisfy ANSI-BIFMA standards for stability, counterweights are required for all lateral files that include roll-out drawers or shelves if they are not ganged together or otherwise anchored
- Fixed and open shelf lateral files do not require counterweights, nor do lateral files that are anchored to a wall or ganged together. See specific lateral file descriptions to determine counterweight requirements

Cabinet Height	Description	Part #	Price
22-5/8" & 23-1/2"	30" box/file c-wt	Add a "W" suffix to the lateral file part number	\$205
22-5/8" & 23-1/2"	36" box/file c-wt		\$226
22-5/8" & 23-1/2"	42" box/file c-wt		\$262
28-3/8"	2 drawer c-wt		\$205
39-7/8"	3 drawer c-wt		\$205
51-3/8"	4 drawer c-wt		\$164
65-7/8"	5 drawer c-wt		\$164
77-3/8"	6 drawer c-wt		\$79

**TRACE
Counterweight
– Sold Separately**

- These counterweights are shipped separately to be installed at the work site
- In order to satisfy ANSI-BIFMA standards for stability, counterweights are required for all lateral files that include roll-out drawers or shelves if they are not ganged together or otherwise anchored
- Fixed and open shelf lateral files do not require counterweights, nor do lateral files that are anchored to a wall or ganged together. See specific lateral file descriptions to determine counterweight requirements

Cabinet Height	Description	Pkg Wt	Pkg Cube	Part #	Price
22-5/8" & 23-1/2"	30" box/file c-wt	42 lb	.7 ft	TRA 2300	\$335
22-5/8" & 23-1/2"	36" box/file c-wt	52 lb	.8 ft	TRA 5500	\$424
22-5/8" & 23-1/2"	42" box/file c-wt	63 lb	.8 ft	TRA 6500	\$493
28-3/8"	2 drawer c-wt	42 lb	.7 ft	TRA 2300	\$335
39-7/8"	3 drawer c-wt	42 lb	.7 ft	TRA 2300	\$335
51-3/8"	4 drawer c-wt	31.5 lb	.6 ft	TRA 4500	\$273
65-7/8"	5 drawer c-wt	31.5 lb	.6 ft	TRA 4500	\$273
77-3/8"	6 drawer c-wt	10.5 lb	.6 ft	TRA 6000	\$132

**Lateral File
Ganging Kit**



- Rather than install a counterweight, an alternate method of ensuring lateral file stability is to gang two or more laterals together side-by-side or back-to-back
- Trace box/file laterals require a counterweight unless they are ganged back-to-back with another lateral file or otherwise tethered to a permanent structure. Without counterweights, ganging box/file laterals side-by-side will not ensure stability
- Ganging kit includes a drill template, screws, and instructions

Description	Pkg Wt	Pkg Cube	Part #	Price
kit to gang two laterals together	1 lb	.2 ft	LME 100010K	\$63

TRACE LATERAL FILES

SIN 33721

TRACE Open Shelf Lateral File With Metal Top



- Box/file open shelf allows for binder storage on 1 adjustable shelf
- 2-high allows for binder storage on 1 adjustable shelf
- 3-high allows for binder storage on 2 adjustable shelves
- Shelves adjust in 1/2" increments
- Counterweight not necessary

H	D	W	Top	Shelf Options	Pkg Wt	Pkg Cube	Part #	Metal Color	Price
28-3/8	18-1/4	30	Metal	2-high	65 lb	10.0 ft	ROS X601	?	\$1,265
28-3/8	18-1/4	36	Metal	OS lateral	77 lb	11.3 ft	ROS X701	?	\$1,318
28-3/8	18-1/4	42	Metal	1 adjustable shelf	88 lb	13.0 ft	ROS X801	?	\$1,447
39-7/8	18-1/4	30	Metal	3-high	79 lb	13.6 ft	ROS X902	?	\$1,403
39-7/8	18-1/4	36	Metal	OS lateral	91 lb	16.1 ft	ROS Y102	?	\$1,457
39-7/8	18-1/4	42	Metal	2 adjustable shelves	103 lb	18.6 ft	ROS Y202	?	\$1,608

Adjustable Metal Shelves

Part #	Description	Pkg Wt	Pkg Cube	Price
FFBX00030	30" Additional Adjustable Shelf	7.95 lb	1.0 ft	\$210
FFBX00036	36" Additional Adjustable Shelf	9.4 lb	1.5 ft	\$220
FFBX00042	42" Additional Adjustable Shelf	10.7 lb	2.0 ft	\$230

TRACE Mobile Lateral File



- Metal top lateral file is identical in structure to our Trace Lateral File
- Counterweight is included
- Includes black 75mm casters (2) locking and (2) non-locking

H	D	W	Top	Cabinet Style	Pkg Wt	Pkg Cube	Part #	Front	Part #	Metal Color	Price
31-1/2	18-1/4	30	metal	2-high	140 lb	11.8 ft	RG	?	C3Q6	?	\$1,878
31-1/2	18-1/4	36	metal	2-high	166.5 lb	14.0 ft	RG	?	C4Q6	?	\$2,009
31-1/2	18-1/4	42	metal	2-high	193 lb	16.2 ft	RG	?	C5Q6	?	\$2,194

Available Fronts | A | B | C | D | E | F | G | H | I | J | K | L | M | N | O | P | Q | S

TRACE Work Surface Supporting Lateral File



- TRACE lateral file without a top
- Includes top channels for mounting under a work surface
- Counterweight is not required if installed beneath a desk work surface or otherwise anchored or ganged to another cabinet
- Not to be used as a freestanding cabinet

H	D	W	Drawer Options	Pkg Wt	Pkg Cube	Part #	Front	Part #	Metal Color	Part #	Price
27-3/4	18-1/4	30	2 drawer	80 lb	11.8 ft	RG	?	C301	?	NT	\$1,439
27-3/4	18-1/4	36	2 drawer	102 lb	14.0 ft	RG	?	C401	?	NT	\$1,536
27-3/4	18-1/4	42	2 drawer	115 lb	16.2 ft	RG	?	C501	?	NT	\$1,681

Available Fronts | A | B | C | F | H | I | J | P | Q | S

TRACE LATERAL FILES

SIN 33721

TRACE Work Surface Supporting Multi-drawer FileCenter

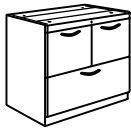

12-12-30



6-6-12-30

- Includes top channels for mounting under a work surface
- All drawers include full-extension steel ball bearing slides
- Counterweight is not required if installed beneath a desk work surface or otherwise anchored or ganged to another cabinet
- Not to be used as a freestanding cabinet, because no counterweight is included
- The inside dimensions of the top box and file drawers are shown on the Trace Lateral FAQs page
- The inside dimension of the bottom lateral drawer are: height - 10.75", width - 27.3", depth - 16.0"

H	D	W	Cabinet Style	Pkg Wt	Pkg Cube	Part #	Front	Part #	Metal Color	Price
27-3/4	18-1/4	30-1/2	12"/12"/30"	95 lb	11.8 ft	WL	?	0102	?	\$1,838
27-3/4	18-1/4	30-1/2	6"/6"/12"/30"	105 lb	11.8 ft	WL	?	0103	?	\$1,924
27-3/4	18-1/4	30-1/2	12"/6"/6"/30"	105 lb	11.8 ft	WL	?	0104	?	\$1,924
27-3/4	18-1/4	30-1/2	6"/6"/6"/6"/30"	115 lb	11.8 ft	WL	?	0105	?	\$1,953

Available Fronts | A | ~~B~~ | ~~C~~ | F | H | ~~K~~ | ~~L~~ | P | Q | S

**TRACE Individual
Lateral File
Laminate Top**



- Laminate top may be factory-installed or shipped separately
- A laminate top may not be placed on a Trace lateral file that includes a flipper door in the top opening
- When factory-installed, the list price shown will be added to the accompanying lateral file price
- A metal top is not included when using a laminate top
- The finish height of a Trace lateral file will be 5/8" taller when using a 1-1/4" laminate top than the height of a Trace lateral file with metal top
- Specify any standard GO laminate and edge. Special order laminates may require an up-charge and/or extended lead-time; call for details
- Laminate tops used on individual lateral files are sized to be flush with the sides of the lateral file case, so that individual files installed side-by-side will have no gaps between

Description	H	W	D	Pkg Wt	Pkg Cube	Part #	Lam/Edge #	Price
factory installed	1.25	30.00	18.25	n/a	n/a	Add laminate color as a suffix to the lateral part number	?	\$474
	1.25	36.00	18.25	n/a	n/a	Add this price to lateral price	?	\$533
	1.25	42.00	18.25	n/a	n/a		?	\$590
top shipped separately	1.25	30.00	18.25	19 lb	.6 ft	FC 1931	?	\$570
	1.25	36.00	18.25	23 lb	.7 ft	FC 1937	?	\$638
	1.25	42.00	18.25	26 lb	1.0 ft	FC 1943	?	\$707

**Laminate
Common Tops
for TRACE
Lateral Files**

- Common laminate tops are shipped separately, to be installed in the field
- A laminate top may not be placed on a Trace lateral file that includes a flipper door in the top opening
- The finish height of a Trace lateral file will be 5/8" taller when using a 1-1/4" laminate top than the height of a Trace lateral file with metal top
- Common top sizes allow for 1/8" overhang on all four sides
- It is recommended that you remove the metal top from lateral files before attaching the common laminate top
- Trace Work Surface Supporting Lateral Files, which are 2 drawer files and do not include metal tops, are available in this price book
- Trace lateral files may be special-ordered to not include metal tops
- Specify any standard GO laminate and edge. Special order laminates may require an up-charge and/or extended lead-time; call for details
- Lateral files that are ganged together with a common top do not need a counterweight

Two Laterals Side-by-Side:	H	W	D	Pkg Wt	Pkg Cube	Part #	Lam/Edge #	Price
(2) 30" Lateral	1.25	60.25	18.50	39 lb	.8 ft	TL 1860	?	\$644
(1) 30" & (1) 36" Lateral	1.25	66.25	18.50	43 lb	.9 ft	TL 1866	?	\$702
(2) 36" Lateral	1.25	72.25	18.50	47 lb	1.0 ft	TL 1872	?	\$759
(2) 42" Lateral	1.25	84.25	18.50	55 lb	1.1 ft	TL 1884	?	\$829

Three Laterals Side-by-Side:	H	W	D	Pkg Wt	Pkg Cube	Part #	Lam/Edge #	Price
(3) 30" Lateral	1.25	90.25	18.50	58 lb	1.2 ft	TL 1890	?	\$838
(3) 36" Lateral	1.25	108.25	18.50	70 lb	1.4 ft	TL 18108	?	\$1,084
(3) 42" Lateral	1.25	126.25	18.50	82 lb	1.7 ft	TL 18126	?	\$1,358

Two Laterals Back-to-Back:	H	W	D	Pkg Wt	Pkg Cube	Part #	Lam/Edge #	Price
(2) 30" Lateral	1.25	30.25	36.75	39 lb	.8 ft	TL 3730	?	\$676
(2) 36" Lateral	1.25	36.25	36.75	47 lb	1.0 ft	TL 3736	?	\$818
(2) 42" Lateral	1.25	42.25	36.75	54 lb	1.1 ft	TL 3742	?	\$825

Four Laterals Back-to-Back:	H	W	D	Pkg Wt	Pkg Cube	Part #	Lam/Edge #	Price
(4) 30" Lateral	1.25	60.25	36.75	77 lb	1.6 ft	TL 3760	?	\$1,087
(4) 36" Lateral	1.25	72.25	36.75	93 lb	1.9 ft	TL 3772	?	\$1,342
(4) 42" Lateral	1.25	84.25	36.75	108 lb	2.2 ft	TL 3784	?	\$1,414

Six Laterals Back-to-Back:	H	W	D	Pkg Wt	Pkg Cube	Part #	Lam/Edge #	Price
(6) 30" Lateral	1.25	90.25	36.75	116 lb	2.5 ft	TL 3790	?	\$1,576
(6) 36" Lateral	1.25	108.25	36.75	138 lb	2.8 ft	TL 37108	?	\$1,891
(6) 42" Lateral	1.25	126.25	36.75	162 lb	3.5 ft	TL 37126	?	\$2,282

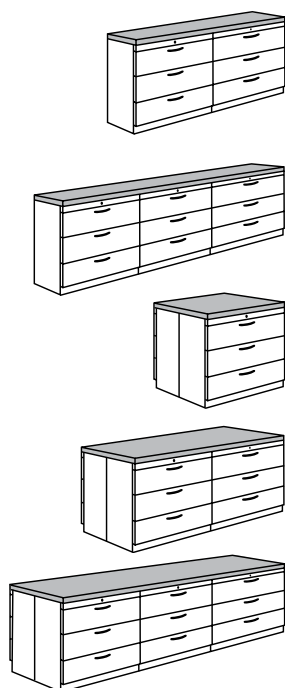

TRACE LATERAL FILES

SIN 33721

TRACE Combo Lateral File/ Storage Cabinet



- Includes two UM Series locks, keyed alike
- Units with 2-high cupboards allow binder storage on one shelf
- Units with 3-high cupboards allow binder storage on two shelves
- Counterweights are required in some models, and are included as standard

H	D	W	# 12" Drawers	Cupbd Ht	Pkg Wt	Pkg Cube	Part #	Front	Part #	Metal Color	Price
51-3/8	18-1/4	30	2 drawer	2-high	166 lb	22.0 ft	RG	?	G7B9	?	\$2,792
51-3/8	18-1/4	36	2 drawer	2-high	181 lb	25.8 ft	RG	?	G8B9	?	\$3,320
51-3/8	18-1/4	42	2 drawer	2-high	206 lb	28.6 ft	RG	?	G9B9	?	\$3,614
65-7/8	18-1/4	30	2 drawer	3-high	188 lb	26.0 ft	RG	?	H1B2	?	\$3,336
65-7/8	18-1/4	36	2 drawer	3-high	203 lb	30.8 ft	RG	?	H2B2	?	\$3,709
65-7/8	18-1/4	42	2 drawer	3-high	234 lb	35.6 ft	RG	?	H3B2	?	\$4,087
65-7/8	18-1/4	30	3 drawer	2-high	183 lb	26.0 ft	RG	?	H4B3	?	\$3,437
65-7/8	18-1/4	36	3 drawer	2-high	212 lb	30.8 ft	RG	?	H5B3	?	\$3,818
65-7/8	18-1/4	42	3 drawer	2-high	231 lb	35.6 ft	RG	?	H6B3	?	\$4,254
77-3/8	18-1/4	30	3 drawer	3-high	206 lb	30.7 ft	RG	?	H7B1	?	\$3,978
77-3/8	18-1/4	36	3 drawer	3-high	234 lb	36.4 ft	RG	?	H8B1	?	\$4,420
77-3/8	18-1/4	42	3 drawer	3-high	260 lb	42.1 ft	RG	?	H9B1	?	\$4,926
77-3/8	18-1/4	30	4 drawer	2-high	210 lb	30.7 ft	RG	?	J1B4	?	\$4,077
77-3/8	18-1/4	36	4 drawer	2-high	230 lb	36.4 ft	RG	?	J2B4	?	\$4,534
77-3/8	18-1/4	42	4 drawer	2-high	254 lb	42.1 ft	RG	?	J3B4	?	\$5,049

B, H, and P fronts will include "A" pull on cupboard doors

Available Fronts | A | B | F | H | P | Q | S

TRACE LATERAL FILES

SIN 33721

TRACE Combo Lateral File/ Open Shelves

- Includes one UM Series lock
- Units with 2-high shelves allow binder storage on one shelf
- Units with 3-high shelves allow binder storage on two shelves
- Counterweights are required in some models, and are included as standard



H	D	W	# 12" Drawers	Shelf Ht	Pkg Wt	Pkg Cube	Part #	Front	Part #	Metal Color	Price
51-3/8	18-1/4	30	2 drawer	2-high	159 lb	22.0 ft	RG	?	F1A8	?	\$2,615
51-3/8	18-1/4	36	2 drawer	2-high	188 lb	25.8 ft	RG	?	F2A8	?	\$2,870
51-3/8	18-1/4	42	2 drawer	2-high	199 lb	28.6 ft	RG	?	F3A8	?	\$3,163
65-7/8	18-1/4	30	2 drawer	3-high	174 lb	26.0 ft	RG	?	F490	?	\$3,003
65-7/8	18-1/4	36	2 drawer	3-high	200 lb	30.8 ft	RG	?	F590	?	\$3,373
65-7/8	18-1/4	42	2 drawer	3-high	216 lb	35.6 ft	RG	?	F690	?	\$3,753
65-7/8	18-1/4	30	3 drawer	2-high	168 lb	26.0 ft	RG	?	F789	?	\$3,159
65-7/8	18-1/4	36	3 drawer	2-high	194 lb	30.8 ft	RG	?	F889	?	\$3,539
65-7/8	18-1/4	42	3 drawer	2-high	212 lb	36.6 ft	RG	?	F989	?	\$3,975
77-3/8	18-1/4	30	3 drawer	3-high	183 lb	30.7 ft	RG	?	G197	?	\$3,645
77-3/8	18-1/4	36	3 drawer	3-high	206 lb	36.4 ft	RG	?	G297	?	\$4,087
77-3/8	18-1/4	42	3 drawer	3-high	229 lb	42.1 ft	RG	?	G397	?	\$4,589
77-3/8	18-1/4	30	4 drawer	2-high	179 lb	30.7 ft	RG	?	G498	?	\$3,800
77-3/8	18-1/4	36	4 drawer	2-high	202 lb	36.4 ft	RG	?	G598	?	\$4,256
77-3/8	18-1/4	42	4 drawer	2-high	224 lb	42.1 ft	RG	?	G698	?	\$4,770

Available Fronts | A | B | ~~D~~ | F | H | ~~K~~ | ~~N~~ | P | Q | S

**Magnetic
Shelf Divider**

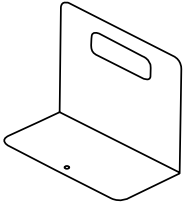

- Black magnetic dividers are 7.5" tall and 8" wide, with a 4" base. Magnet is 7-7/8" x 3"
- Appropriate for use on any lateral file drawer or shelf, bookcase, or double door storage cabinet

H	D	W	Description	Pkg Wt	Pkg Cube	Part #	Price
7-1/2	4	8	(package of 3)	2 lb	2 ft	LFM 300 30	\$76

Magnetic Label



- Magnetic labels adhere to any metal surface to identify contents
- Label dimensions are 1" high x 3" wide

Description	H	W	Pkg Wt	Pkg Cube	Part #	Price
(package of 10)	1	3	.2 lb	.08 ft	TGOX 000 11K	\$53

**Lateral File
Conversion Bar**

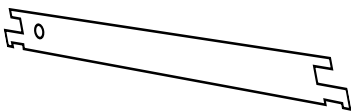

- Conversion bars allow for front-to-back filing in 18-1/4" and 17-3/8" deep lateral files. Use 2 bars each in 36" and 42" lateral drawers for legal size filing

Description	Pkg Wt	Pkg Cube	Part #	Price
(package of 4)	2 lb	.8 ft	LME 4500 19	\$42

"How many standard file conversion bars do I need?"

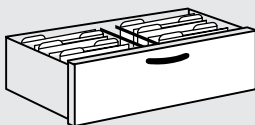

- 30" Wide Lateral**
- 2 file conversion bars per drawer
 - 15.5" x 2 rows = 31" filing space

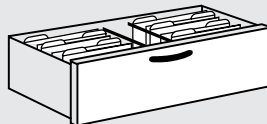

- 36" Wide Lateral**
- 2 file conversion bars per drawer
 - 15.5" x 2 rows = 31" filing space

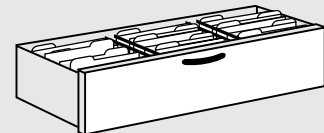

- 42" Wide Lateral**
- 4 file conversion bars per drawer
 - 15.5" x 3 rows = 46.5" filing space

**Drawer Front
Filler For TRACE
Lateral Files**

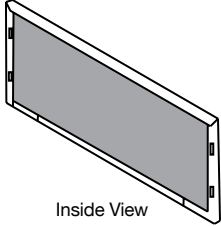

- Lateral drawers may be upgraded to include a closed cell polyethylene filler piece that adheres to the inside of the drawer front for improved sound dampening
- Drawer Front Filler upgrades, priced per drawer, will be added to the product list price

Descriptions	Pkg Wt	Pkg Cube	Part #	Price Per Drawer
price per drawer	2 lb	.8 ft	Add a "U" as a suffix to the part number	\$92
Available Fronts A B D F H J K P Q S				

**Magnetic
Drawer Dividers
For Box Drawer**

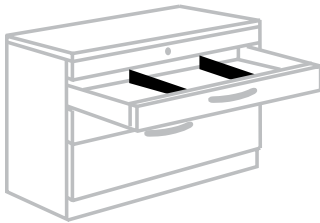

- Dividers fit inside box lateral drawer bins to create sectioned drawer space
- 16" depth divider fits front-to-back in drawer bin, painted black
- Magnets attach to front and back of drawer bin

Description	Pkg Wt	Pkg Cube	Part #	Price
pkg of (4) 16" x 4" dividers	22 lb	1.8 ft	LFM 40042K	\$133



Basic Construction

- While TRACE lateral files feature horizontal lines and full-width fronts consistent with all other TRACE products, Recessed Front lateral files have in-set drawer fronts and the flipper doors stow inside the cabinet
- Recessed Front lateral files finish at different heights and have completely different horizontal lines than the TRACE products
- Recessed Front lateral files are available with three different front styles:
A: Full Pull, F: Square Recessed Pull, and H: HW Pull. These recessed style pulls allow the 12" flipper door to recede fully inside the cabinets
- All Great Openings products meet or exceed applicable ANSI-BIFMA standards for durability and safety
- Steel frame construction is welded and channels are formed in key areas for strength
- Reinforced vertical and horizontal channels ensure dimensional stability
- Inner frame is 20 gauge metal. Fronts, tops, outer panels are 20 and 22 gauge. Drawer bins and shelves are 18 and 20 gauge
- Four leveling glides with 7/8" adjustment are included to ensure proper drawer alignment and operation

Features

- Positive self-closing hinges and door follower channel provide superior flipper door tracking and a snug door closure. The doors are drawn in when closed to ensure uniform door alignment
- Flipper doors include a built-in sound absorption feature in the flipper door for quiet operation
- 12" receding flipper doors stow completely inside the cabinet
- 15" receding flipper doors extend 2-1/4" outside the front of the cabinet. Please allow for this clearance when creating your floor plan
- All drawers and roll-out shelves include full extension steel ball-bearing slides with anti-rebound features to ensure smooth operation
- Drawer includes full-height side panels
- Two file bars are included in each drawer for side-to-side filing
- All Great Openings' lateral drawer bins will accommodate A4, Letter, and Legal size filing

Options and Accessories

- All options and accessories are sold separately or are available as an upgrade
- Laminate drawer fronts may be specified. See the Specification Guide for details
- Common laminate tops
- Polyethylene drawer front fillers increase sound absorption
- File conversion bars for front-to-back filing
- Magnetic shelf dividers
- Magnetic label

Lock System

- All Great Openings products include randomly-assigned UM Series locks
- UM locks are black-faced, master-keyed, and core-removable
- Locks may be keyed-alike in the field
- Other key series are available, including Haworth SL, bright nickel LL, and Knoll K. See the Specification Guide for details and how to order
- The locking system captures drawer fronts on both sides

Counterweight & Interlock

- The safety interlock mechanism is integrated into the drawer slides, allowing only one drawer to open at a time
- All lateral files with drawers and roll-out shelves used as freestanding cabinets must have counterweight if not ganged together or otherwise anchored
- Counterweights may be factory-installed or purchased separately to be installed in the field

Load Capacity

- Drawer and roll-out shelf load capacity:
 - 30", 36", and 42" wide drawers: 125 lb
- Fixed and adjustable shelf load capacity:
 - 30" shelf: 95 lbs
 - 36" shelf: 116 lbs
 - 42" shelf: 136 lbs
- Lateral file metal top load capacity:
 - 30" wide top: 140 lbs
 - 36" wide top: 168 lbs
 - 42" wide top: 192 lbs

Inside Dimensions

(in inches)

	Inner Height	Inner Width	Inner Depth
File Drawers			
30" wide	11.25"	26.7"	16.0"
36" wide	11.25"	32.7"	16.0"
42" wide	11.25"	38.7"	16.0"
12" Receding Door (fixed shelves)			
30" wide	10.3"	28.6"	16.5"
36" wide	10.3"	34.6"	16.5"
42" wide	10.3"	40.6"	16.5"
12" Receding Door (roll-out shelves)			
30" wide	10.25"	26.7"	16.0"
36" wide	10.25"	32.7"	16.0"
42" wide	10.25"	38.7"	16.0"
15" Receding Door (fixed shelves)			
30" wide	12.5"	28.6"	16.5"
36" wide	12.5"	34.6"	16.5"
42" wide	12.5"	40.6"	16.5"

RECESSED FRONT LATERAL FILES

SIN 33721

Recessed Front Lateral File



- 3-high and 5-high lateral files may be specified with all drawers, or with a receding door in the top opening with either a fixed or rollout shelf
- The receding door in these lateral files is approximately 12" high; when open, the door stows fully inside the cabinet
- Counterweight required if not ganged together or otherwise anchored
- Individual locking drawers not available

H	D	W	Cabinet Style	Contains	Pkg Wt	Pkg Cube	Part #	Front	Part #	Metal Color	Price
27-3/4	17-3/8	30	2-high	2 drawers	93 lb	11.8 ft	RG	?	0101	?	\$1,702
27-3/4	17-3/8	36	2-high	2 drawers	108 lb	14.0 ft	RG	?	0201	?	\$1,894
27-3/4	17-3/8	42	2-high	2 drawers	123 lb	16.2 ft	RG	?	0301	?	\$2,070
39-7/8	17-3/8	30	3-high	3 drawers	129 lb	16.5 ft	RG	?	0402	?	\$2,239
39-7/8	17-3/8	36	3-high	3 drawers	150 lb	19.6 ft	RG	?	0502	?	\$2,475
39-7/8	17-3/8	42	3-high	3 drawers	171 lb	22.7 ft	RG	?	0602	?	\$2,700
39-7/8	17-3/8	30	3-high	2 drawers 1 rec. door, fixed shelf	129 lb	16.5 ft	RG	?	04D6	?	\$2,370
39-7/8	17-3/8	36	3-high	2 drawers 1 rec. door, fixed shelf	150 lb	19.6 ft	RG	?	05D6	?	\$2,756
39-7/8	17-3/8	42	3-high	2 drawers 1 rec. door, fixed shelf	171 lb	22.7 ft	RG	?	06D6	?	\$3,141
52	17-3/8	30	4-high	4 drawers	166 lb	21.3 ft	RG	?	0703	?	\$2,765
52	17-3/8	36	4-high	4 drawers	192 lb	25.2 ft	RG	?	0803	?	\$3,047
52	17-3/8	42	4-high	4 drawers	218 lb	29.1 ft	RG	?	0903	?	\$3,323
64-1/8	17-3/8	30	5-high	5 drawers	202 lb	26.0 ft	RG	?	1008	?	\$3,614
64-1/8	17-3/8	36	5-high	5 drawers	235 lb	31.0 ft	RG	?	1108	?	\$4,001
64-1/8	17-3/8	42	5-high	5 drawers	268 lb	35.6 ft	RG	?	1208	?	\$4,386
64-1/8	17-3/8	30	5-high	4 drawers 1 rec. door, fixed shelf	202 lb	26.0 ft	RG	?	1011	?	\$3,337
64-1/8	17-3/8	36	5-high	4 drawers 1 rec. door, fixed shelf	235 lb	31.0 ft	RG	?	1111	?	\$3,621
64-1/8	17-3/8	42	5-high	4 drawers 1 rec. door, fixed shelf	268 lb	35.6 ft	RG	?	1211	?	\$3,895
64-1/8	17-3/8	30	5-high	4 drawers 1 rec. door, rollout shelf	202 lb	26.0 ft	RG	?	1004	?	\$3,614
64-1/8	17-3/8	36	5-high	4 drawers 1 rec. door, rollout shelf	235 lb	31.0 ft	RG	?	1104	?	\$4,001
64-1/8	17-3/8	42	5-high	4 drawers 1 rec. door, rollout shelf	268 lb	35.6 ft	RG	?	1204	?	\$4,386

Available Fronts | A  F | H 

**Recessed Front
Lateral File
Counterweight
- Factory Installed**

- In order to satisfy ANSI-BIFMA standards for stability, counterweights are required for all lateral files that include roll-out drawers or shelves if they are not ganged together or otherwise anchored
- Fixed shelf lateral files do not require counterweights, nor do lateral files that are anchored to a wall or ganged together. See specific lateral file descriptions to determine counterweight requirements

Description	Part #	Price
2 drawer c-wt		\$254
3 drawer c-wt	Add a "W" suffix to the lateral file part number	\$202
4 drawer c-wt		\$145
5 drawer c-wt		\$95

**Recessed Front
Lateral File
Counterweight
- Sold Separately**

- These counterweights are shipped separately to be installed at the work site
- In order to satisfy ANSI-BIFMA standards for stability, counterweights are required for all lateral files that include roll-out drawers or shelves if they are not ganged together or otherwise tethered
- Fixed shelf lateral files do not require counterweights, nor do lateral files that are anchored to a wall or ganged together. See specific lateral file descriptions to determine counterweight requirements

Description	Pkg Wt	Pkg Cube	Part #	Price
2 drawer c-wt	42 lb	.7 ft	SME 220019	\$348
3 drawer c-wt	31.5 lb	.7 ft	SME 230019	\$298
4 drawer c-wt	21 lb	.6 ft	SME 240019	\$202
5 drawer c-wt	10.5 lb	.6 ft	SME 250019	\$123

**Lateral File
Ganging Kit**

- Rather than install a counterweight, an alternate method of ensuring lateral file stability is to gang two or more laterals together side-by-side
- Ganging kit includes a drill template, screws, and instructions for attaching two laterals together



Description	Pkg Wt	Pkg Cube	Part #	Price
kit to gang laterals together	1 lb	.2 ft	LME 100010K	\$63

Spec Guide Personal Storage Pedestals **Laterals** Collab. Islands Lockers Lam Lockers Towers Storage Cabinets Bookcases Cayenne Ht Adj Tables Trace Desk Desk Accs Sparkology Terms/Conds

RECESSED FRONT LATERAL FILES

SIN 33721

12" Receding Door Lateral File with Roll-Out or Fixed Shelves

- All doors flip-up and recede fully inside the cabinet
- Choose from fixed or roll-out shelves
- Counterweight is required in lateral files with roll-out shelves if not ganged together or otherwise anchored



H	D	W	Cabinet Style	Contains	Pkg Wt	Pkg Cube	Part #	Front	Part #	Metal Color	Price
27-3/4	17-3/8	30	2-high		82 lb	11.8 ft	RG	?	0142	?	\$2,288
27-3/4	17-3/8	36	2-high	2 rec. doors roll-out shelves	104 lb	14.0 ft	RG	?	0242	?	\$2,668
27-3/4	17-3/8	42	2-high		118 lb	16.2 ft	RG	?	0342	?	\$2,988
39-7/8	17-3/8	30	3-high		127 lb	16.5 ft	RG	?	0421	?	\$3,100
39-7/8	17-3/8	36	3-high	3 rec. doors fixed shelves	148 lb	19.6 ft	RG	?	0521	?	\$3,519
39-7/8	17-3/8	42	3-high		169 lb	22.7 ft	RG	?	0621	?	\$3,954
39-7/8	17-3/8	30	3-high		129 lb	16.5 ft	RG	?	0443	?	\$3,217
39-7/8	17-3/8	36	3-high	3 rec. doors roll-out shelves	150 lb	19.6 ft	RG	?	0543	?	\$3,636
39-7/8	17-3/8	42	3-high		171 lb	22.7 ft	RG	?	0643	?	\$4,064
52	17-3/8	30	4-high		147 lb	21.3 ft	RG	?	0722	?	\$3,946
52	17-3/8	36	4-high	4 rec. doors fixed shelves	171 lb	25.2 ft	RG	?	0822	?	\$4,499
52	17-3/8	42	4-high		204 lb	29.1 ft	RG	?	0922	?	\$5,149
52	17-3/8	30	4-high		149 lb	21.3 ft	RG	?	0744	?	\$4,064
52	17-3/8	36	4-high	4 rec. doors roll-out shelves	173 lb	25.2 ft	RG	?	0844	?	\$4,617
52	17-3/8	42	4-high		207 lb	29.2 ft	RG	?	0944	?	\$5,149
64-1/8	17-3/8	30	5-high		179 lb	26.0 ft	RG	?	1023	?	\$4,848
64-1/8	17-3/8	36	5-high	5 rec. doors fixed shelves	214 lb	30.8 ft	RG	?	1123	?	\$5,455
64-1/8	17-3/8	42	5-high		236 lb	35.6 ft	RG	?	1223	?	\$6,107
64-1/8	17-3/8	30	5-high		181 lb	26.0 ft	RG	?	1045	?	\$4,969
64-1/8	17-3/8	36	5-high	5 rec. doors roll-out shelves	216 lb	30.8 ft	RG	?	1145	?	\$5,575
64-1/8	17-3/8	42	5-high		238 lb	35.6 ft	RG	?	1245	?	\$6,224

Available Fronts | A   F | H     

RECESSED FRONT LATERAL FILES

SIN 33721

15" Receding Door Lateral File with Fixed Shelves



- All doors flip-up and recede inside cabinet
- When open, 15" receding flipper doors extend 2-1/4" outside the front of the cabinet
- All shelves are fixed
- No counterweight is necessary

H	D	W	Cabinet Style	Contains	Pkg Wt	Pkg Cube	Part #	Front	Part #	Metal Color	Price
64-1/8	17-3/8	30	4-high	4 door	178 lb	26.0 ft	RG	?	1049	?	\$3,107
64-1/8	17-3/8	36	4-high	4 door	213 lb	30.8 ft	RG	?	1149	?	\$3,454
64-1/8	17-3/8	42	4-high	4 door	228 lb	35.6 ft	RG	?	1249	?	\$3,804
79-3/8	17-3/8	30	5-high	5 door	186 lb	26.0 ft	RG	?	1650	?	\$3,818
79-3/8	17-3/8	36	5-high	5 door	220 lb	37.7 ft	RG	?	1750	?	\$4,245
79-3/8	17-3/8	42	5-high	5 door	238 lb	43.6 ft	RG	?	1850	?	\$4,671

Available Fronts | A F | H

15" Receding Door Lateral File with Standard Drawers



- Top 1 or 2 openings include 15" flipper doors that recede inside the cabinet, with fixed shelves
- When open, 15" receding flipper doors extend 2-1/4" outside the front of the cabinet
- Bottom 3 or 4 openings include standard height drawers
- Counterweights are required if not ganged together or otherwise anchored

H	D	W	Cabinet Style	Contains	Pkg Wt	Pkg Cube	Part #	Front	Part #	Metal Color	Price
67-1/8	17-3/8	30	5-high	(1) 15" receding doors fixed shelf 4 std drawers	202 lb	22.9 ft	RG	?	3970	?	\$3,825
67-1/8	17-3/8	36	5-high	(1) 15" receding doors fixed shelf 4 std drawers	237 lb	27.5 ft	RG	?	4070	?	\$3,910
67-1/8	17-3/8	42	5-high	(1) 15" receding doors fixed shelf 4 std drawers	252 lb	32.1 ft	RG	?	4170	?	\$4,078
70-1/4	17-3/8	30	5-high	(2) 15" receding doors fixed shelf 3 std drawers	166 lb	23.4 ft	RG	?	2475	?	\$3,872
70-1/4	17-3/8	36	5-high	(2) 15" receding doors fixed shelf 3 std drawers	200 lb	28.1 ft	RG	?	2575	?	\$3,952
70-1/4	17-3/8	42	5-high	(2) 15" receding doors fixed shelf 3 std drawers	218 lb	32.8 ft	RG	?	2675	?	\$4,149

Available Fronts | A F | H

Individual Laminate Tops for Recessed Front Lateral



- Factory installed or shipped separately
- List price shown will be added to the accompanying lateral price
- Metal top is not included when using a laminate top
- Finish height of lateral file will be 5/8" taller than the height of a standard Recessed Front lateral file with metal top
- Specify any standard GO laminate and edge. Special order laminates may require an up-charge; call for details
- Laminate tops used on individual lateral files are sized to be flush with the sides of the lateral, so that individual laterals installed side-by-side will have no gaps between

Description	H	W	D	Pkg Wt	Pkg Cube	Part #	Lam/Edge #	Price
factory installed	1.25	30.00	17.375	n/a	n/a	Add laminate color number as a suffix to the lateral part number	?	\$474
	1.25	36.00	17.375	n/a	n/a		?	\$533
	1.25	42.00	17.375	n/a	n/a		?	\$590
top shipped separately	1.25	30.00	17.375	19 lb	.6 ft	SLEX030	?	\$570
	1.25	36.00	17.375	23 lb	.7 ft	SLEX036	?	\$638
	1.25	42.00	17.375	26 lb	1.0 ft	SLEX042	?	\$707

Common Laminate Tops for Recessed Front Lateral



- Laminate tops ordered separately for field installation
- Specify any standard GO laminate and edge. Special order laminates may require an up-charge; call for details
- Note that these tops will fit ONLY Recessed Lateral Files
- It is recommended that you remove the metal top from lateral files before attaching the common laminate top

Two Laterals Side-by-Side:	W	D	Pkg Wt	Pkg Cube	Part #	Lam/Edge #	Price
(2) 30" laterals	60.25	17.625	37 lb	.8 ft	LL1760	?	\$644
(1) 30" & (1) 36" lateral	66.25	17.625	41 lb	.9 ft	LL1766	?	\$702
(2) 36" laterals	72.25	17.625	45 lb	1.0 ft	LL1772	?	\$759
(2) 42" laterals	84.25	17.625	52 lb	1.1 ft	LL1784	?	\$829

Three Laterals Side-by-Side:	W	D	Pkg Wt	Pkg Cube	Part #	Lam/Edge #	Price
(3) 30" laterals	90.25	17.625	56 lb	1.2 ft	LL1790	?	\$838
(3) 36" laterals	108.25	17.625	67 lb	1.4 ft	LL17108	?	\$1,084
(3) 42" laterals	126.25	17-5/8	78 lb	1.7 ft	LL17126	?	\$1,358

Two Laterals Back-to-Back:	W	D	Pkg Wt	Pkg Cube	Part #	Lam/Edge #	Price
(2) 30" laterals	30.25	35.00	37 lb	.8 ft	LL 3530	?	\$676
(2) 36" laterals	36.25	35.00	45 lb	1.0 ft	LL 3536	?	\$818
(2) 42" laterals	42.25	35.00	52 lb	1.1 ft	LL 3542	?	\$825

Four Laterals in Quads:	W	D	Pkg Wt	Pkg Cube	Part #	Lam/Edge #	Price
(4) 30" laterals	60.25	35.00	74 lb	1.6 ft	LL 3560	?	\$1,087
(4) 36" laterals	72.25	35.00	88 lb	1.9 ft	LL 3572	?	\$1,342
(4) 42" laterals	84.25	35.00	103 lb	2.2 ft	LL 3584	?	\$1,414

**Magnetic Shelf
Divider**

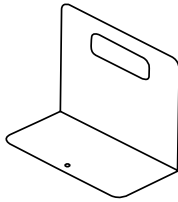

- Black magnetic dividers are 7.5" tall and 8" wide, with a 4" base. Magnet is 7-7/8" x 3"
- Appropriate for use on any lateral file drawer or shelf, bookcase, double door storage cabinet or overhead storage cabinet

H	D	W	Description	Pkg Wt	Pkg Cube	Part #	Price
7-1/2	4	8	(package of 3)	2 lb	2 ft	LFM 300 30	\$76

Magnetic Label



- Magnetic labels adhere to any metal surface to identify drawer contents
- Label dimensions are 1" high x 3" wide

H	W	Description	Pkg Wt	Pkg Cube	Part #	Price
1	3	(package of 10)	.2 lb	.08 ft	TGOX 000 11K	\$53

**Lateral File
Conversion Bar**



- Conversion bars allow for front-to-back filing in 18-1/4" and 17-3/8" deep lateral files. Use 2 bars each in 36" and 42" lateral drawers for legal size filing

Description	Pkg Wt	Pkg Cube	Part #	Price
(package of 4)	2 lb	.8 ft	LME 4500 19	\$42

"How many standard file conversion bars do I need?"

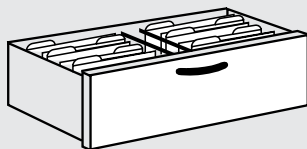

- 30" Wide Lateral**
- 2 file conversion bars per drawer
 - 15.5" x 2 rows = 31" filing space

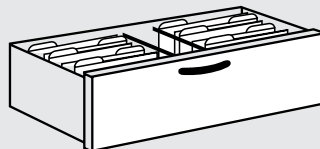

- 36" Wide Lateral**
- 2 file conversion bars per drawer
 - 15.5" x 2 rows = 31" filing space

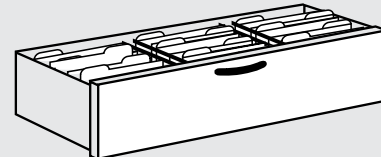

- 42" Wide Lateral**
- 4 file conversion bars per drawer
 - 15.5" x 3 rows = 46.5" filing space

**Drawer
Front Filler
For Recessed
Lateral Files**

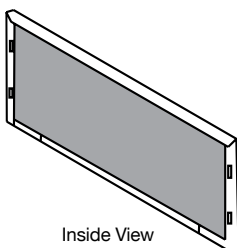

Inside View

- Lateral drawers may be upgraded to include a closed cell polyethylene filler piece that adheres to the inside of the drawer front for improved sound dampening
- Drawer Front Filler upgrades, priced per drawer, will be added to the product list price
- For Recessed Front Lateral Files, these drawer front fillers are not needed on flipper doors, because we provide other sound-absorbent material in the door construction

Descriptions	Pkg Wt	Pkg Cube	Part #	Price/Drawer
Price per drawer	2 lb	.8 ft	Add a "U" as a suffix to the part number	\$92

Available Fronts | A B C D E F G H I J K L M N O P Q R S

FEATURES

- Flush toekick provides finished look when adding laminate end panels
- Two file bars are included for 12" drawers for side-to-side filing. File conversion bars for front-to-back filing are sold separately
- 12" drawer bins will accommodate A4, Letter, and Legal size filing
- Units provided with metal top with access holes to allow for laminate common top attachment
- Four leveling glides ensure proper alignment and operation
- Available with Bar or Loop pulls
- Upper cubby inside dimension: 11.7"H x 17.5"D x 28.5"W, 11.7"H x 17.5"D x 34.5"W



Q. Satin Nickel Bar Pull



S. Satin Nickel Loop Pull
(Add "B" suffix for black pull)

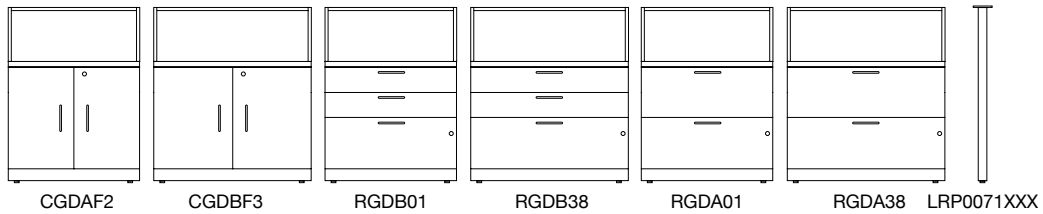

H	D	W	Description	Part #	Front	Part #	Metal Color	List Price
39-7/8	18-1/4	30	Double door island storage cabinet with open cubby above.	CG	?	DAF2	?	\$2,671
39-7/8	18-1/4	36	Double door island storage cabinet with open cubby above.	CG	?	DBF3	?	\$2,727
39-7/8	18-1/4	30	Box/box/file island storage cabinet with open cubby above.	RG	?	DA38	?	\$2,762
39-7/8	18-1/4	36	Box/box/file island storage cabinet with open cubby above.	RG	?	DB38	?	\$2,928
39-7/8	18-1/4	30	File/file island storage cabinet with open cubby above.	RG	?	DA01	?	\$2,685
39-7/8	18-1/4	36	File/file island storage cabinet with open cubby above.	RG	?	DB01	?	\$2,852
Support Leg package of 2 for cantilever applications				LRP0071XXX			?	\$549

**Units do NOT have counterweights and Included metal tops are intended only for use with common tops. Please consult our sales quoting team for larger common tops sizes and openings. Additional support leg(s) or stiffeners may be required.

LAMINATE END PANELS AND TOPS

	H	D	W	Description	Part #	Lam Finish	List Price
	40	18-1/2	1-1/4	Single depth laminate end panel	EPTL18539	?	\$489
	40	37	1-1/4	Double depth laminate end panel	EPTL3739	?	\$648
TL1860	1-1/4	18-1/2	60-1/4	Common top for (2) 30" wide units without laminate ends	TL1860	?	\$644
TL1866	1-1/4	18-1/2	66-1/4	Common top for a 30" and 36" wide units, without laminate ends	TL1866	?	\$702
TL1872	1-1/4	18-1/2	72-1/4	Common top for (2) 36" wide units, without laminate ends	TL1872	?	\$759
TL3760	1-1/4	37	60-1/4	Common top for (2) 30" wide units, back to back without laminate ends	TL3760	?	\$1,087
TL3772	1-1/4	37	72-1/4	Common top for (2) 36" wide units, back to back without laminate ends	TL3772	?	\$1,342
TL1890	1-1/4	18-1/2	90-1/4	Common top for (2) 30" wide units and 30" overhang for seating. (Must order support legs separately)	TL1890	?	\$838
TL18102	1-1/4	18-1/2	102-1/4	Common top for (2) 36" wide units and 30" overhang for seating. (Must order support legs separately)	TL18102	?	\$1,012
TL3790	1-1/4	37	90-1/4	Common top for (2) 30" wide units, back to back, and 30" overhang for seating. (Must order support legs separately)	TL3790	?	\$1,576
TL37102	1-1/4	37	102-1/4	Common top for (2) 36" wide units, back to back, and 30" overhang for seating. (Must order support legs separately)	TL37102	?	\$1,645
TL186275	1-1/4	18-1/2	62-3/4	Common top for (2) 30" wide units WITH laminate ends - ordered separately	TL186275	?	\$688
TL186875	1-1/4	18-1/2	68-3/4	Common top for a 30" and 36" wide unit WITH laminate ends. Order end panels separately	TL186875	?	\$695
TL187475	1-1/4	18-1/2	74-3/4	Common top for (2) 36" wide units WITH laminate ends. Order end panels separately	TL187475	?	\$765
TL376275	1-1/4	37	62-3/4	Common top for (2) 30" wide units back to back WITH laminate ends. Order end panels separately	TL376275	?	\$1,097
TL377475	1-1/4	37	74-3/4	Common top for (2) 36" wide units back to back WITH laminate ends. Order end panels separately	TL377475	?	\$1,352

Spec Guide Personal Storage Pedestals Lateralis Collab. Islands Lockers Lam Lockers Towers Storage Cabinets Bookcases Cayenne Ht Adj Tables Trace Desk Desk Accs Sparkology Terms/Conds

Basic Construction

- All Great Openings products meet or exceed applicable ANSI-BIFMA standards for durability and safety
- Welded steel frame construction and formed channels ensure strength in key areas
- Reinforced vertical and horizontal channels ensure dimensional stability
- Top and side channels are 20 gauge cold rolled steel. Fronts, tops, outer panels are 20 and 22 gauge. Shelves are 18 and 20 gauge
- Four leveling glides with 7/8" adjustment ensure proper alignment and operation, and are accessible from inside the locker
- Lockers include inner side panels, so that structural components are concealed
- The front-facing kick plate on Trace lockers is 3.25" high

Features

- Lockers are shipped fully assembled
- Lockers may be ordered with metal or laminate fronts
- Multiple color door order forms make it easy to mix and match door colors
- Lockers include either coat hooks or coat rod; see individual product descriptions
- Additional shelves are available for order
- All single door lockers include shelf clip holes in the side panels, to accommodate additional shelves that are sold separately. The top-most shelf position allows for 12" clear height above the shelf.

Options and Accessories

- All options and accessories are sold separately or are available as an upgrade
- Choose from keyed locks, electronic locks, or hasp locks
- Interior power outlets may be installed inside locker compartments. Contact Sales for specification and pricing
- Locker door number plates, stainless steel laser etched with any combination of numbers needed to permanently identify individual locker doors
- Laminate common tops
- Locker ganging kit, for ganging lockers side-to-side
- Sloped tops
 - 18" D top is 7.12" H. increases cabinet height 6.50"
 - 24" D top is 9.30" H, increases cabinet height 8.68"
- Locker venting
- Mail slots

Plug 'n Play USB Charging

- Plug and play components
- Preconfigured kits for easy ordering
- 110v plug in feed for up to 8 lockers
- Total 25W power output
- Intelligent USB Type C with Power Delivery
- Reversible USB Type A with Fast Charge
- Internal overload protection
- LED Power Delivery indication

Keyed Lock System

- Keyed locks include randomly-assigned UM Series locks
- UM locks are black-faced, master-keyed, and core-removable
- Locks may be keyed-alike in the field
- Other key series are available, including Haworth SL, bright nickel LL, and Knoll K. See the Specification Guide for details and how to order

Hasp Locks

- Hasp locks may be used instead of a keyed or electronic lock
- Hasp lock on metal door includes the A: Full Pull
- Available on laminate doors
- To order, specify "Hasp Lock" in the product description on your purchase order and add \$55 list per door to the keyed locker price

Standard Door Pulls



Sloped tops



Vents



Mail Slots



Plug 'N Play USB Charging

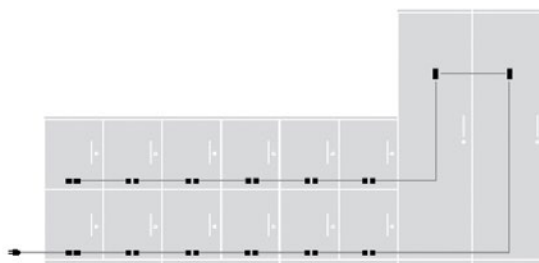

Power routing on backs of lockers

For customer specified electronic or RFID locks, please call for quote.



E-Lock (E)

- Durable and versatile, electronic locks may be programmed to either fixed or revolving mode
Fixed Mode: Once a code is created, that code remains in effect until the user changes it.
Revolving Mode: Code is cleared after each complete locking cycle.
- Electronic Lock Features:
 - Once a code is entered, the lock is activated by turning the lever to the locked or unlocked position
 - Runs on (2) AAA batteries (included)
 - Operates using a 4-to-8 digit code
 - A supervisor code is included
 - For large projects, the supervisor code may be pre-programmed into locks
 - May be programmed by the supervisor as Fixed or Revolving Code
 - Includes programmable reset features
 - Easy to clean membrane keypad
 - 75,000 plus cycles; extended battery life reduces replacement and labor maintenance costs
- 1 year warranty

Pearl (PR)

- Front loaded batteries; accessible even when locked
- Ultra thin – Pearl has the lowest keypad surface height of any electronic keypad lock
- Features programmable user codes, supervisor code and modes of operation
 - programming is easy and does not require special keys or tools
- 40,000 operating cycles or five years of battery life
- 20 codes per lock: 19 user codes and one supervisor code

Mechanical Lock (OJ)

- Non Handed – Lock fits LH or RH doors
- Key free operation – No need to manage or issue keys to open lock
- Public or Private mode – Lock can be assigned for shared or personal use
- Integrated code finder – Management can recover lost code and reset lock if required
- Lock status indicator – Visually identifies if locker is free or occupied
- Integrated pull handle – Facilitates easy door opening
- Low maintenance – Robust mechanism, no batteries required
- ADA options – Accessories available to assist ADA users
- Key override – Management ability to override all codes with master key
- Interchangeable key cores – Giving ultimate management key control should a key be lost or compromised. Cores are supplied keyed alike.

Nano E-Lock Mini Keypad (WE)

- Access with ADA-compliant keypad or free Wesko App
- All metal construction
- All metal housing
- Brushed nickel finish

**Slope Top
Dimensions**

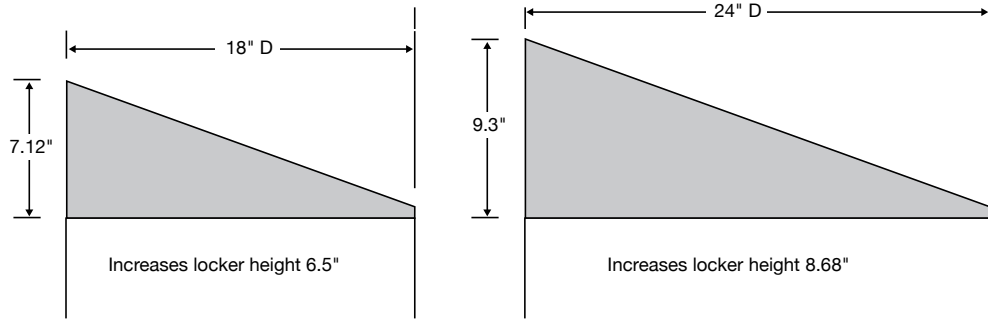

TRACE Locker Inside Dimensions (in inches)

Description	Interior Dimension Per/Locker Opening					
	Height	Width			Depth	
		12" W	15" W	18" W	18" D	24" D
Single Lockers						
Single Locker 27-3/4"H	23.750"	10.580"	13.580"	16.580"	17.156"	23.156"
Single Locker 34-3/4"H	30.750"	10.580"	13.580"	16.580"	17.156"	23.156"
Single Locker 39-7/8"H	35.875"	10.580"	13.580"	16.580"	17.156"	23.156"
Single Locker 51-3/8" H	47.375"	10.580"	13.580"	16.580"	17.156"	23.156"
Single Locker 65-7/8"H	61.875"	10.580"	13.580"	16.580"	17.156"	23.156"
Above Shelf	12.000"	10.580"	13.580"	16.580"	17.156"	23.156"
Double Lockers						
Top Locker	30.828"	10.580"	13.580"	16.580"	17.156"	23.156"
Bottom Locker	30.279"	10.580"	13.580"	16.580"	17.156"	23.156"
Quad Lockers						
Top Lockers	30.828"	10.580"	13.580"		17.156"	23.156"
Bottom Lockers	30.279"	10.580"	13.580"		17.156"	23.156"
Cubby Lockers						
3 H 65-78"H	20"	10.580"	13.580"		17.156"	
All Other Cubbies	14.750"	10.580"	13.580"		17.156"	
Personal Locker						
Personal Locker	61.875"	See sell sheet for details			17.156"	
Above Shelf	12.000"				17.156"	
Mini Lockers						
Freestanding and Mobile	16.250"	8.580"			17.406"	



Pair with Slim XLT
(sold separately)

Garage

- Each locker compartment is paired with Slim XLT mobile storage
- Each locker is keyed alike with companion Slim XLT
- Includes one adjustable shelf per locker
- Includes (2) two-pronged coat hooks per locker
- [Some assembly is required](#)

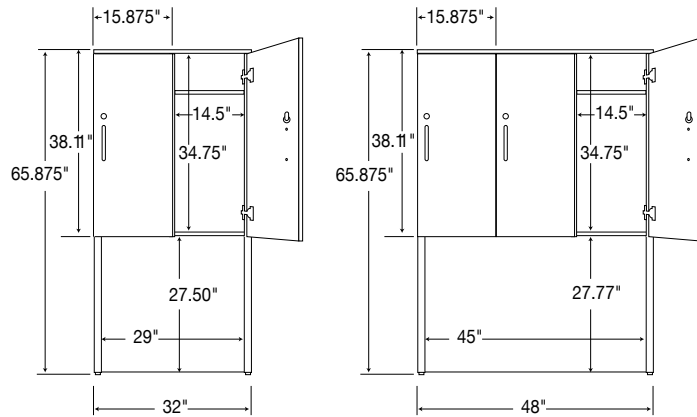

Part #	Description	Base Price	Lam Door	E-Lock & Pearl Lock	Nano E-Lock Mini Keypad	Mech Lock	Hasp	Pkg Wt	Pkg Cube
AYY1XXX	Locker Garage – 2 Stall 32"w x 24"D x 65-7/8"H	\$3,970	+\$843	+\$920	+\$640	+\$640	+\$110	124 lbs	20.5 ft
AZY2XXX	Locker Garage – 3 Stall 48"w x 24"D x 65-7/8"H	\$4,931	+\$1,265	+\$1,380	+\$960	+\$960	+\$165	175 lbs	30 ft

For customer specified electronic or RFID locks, please call for quote.

Hinge

- L Left
- R Right

Key Locks

See page 11 for available options

Available Fronts

- A Full Pull
- S Satin Nickel Loop
- Q Bar Pull
- E Electronic and Mechanical Locks - see page 47
- V Venting (select A, S, Q pull, or electronic lock)
- M Mail Slot (select A, S, Q pull, or electronic lock)

Note: When selecting E-lock only E or A fronts can be used

Paint & Laminate

See Finish Center for available options



Single Lockers

- 27-3/4" high lockers include one adjustable shelf, but no coat rod or hooks
- 34-3/4" high locker includes coat hook and slots for adjustable shelves
- 39-7/8" high lockers include coat hooks or rods and optional shelves
- 51-3/8" and 65-7/8" high lockers include one adjustable shelf on top, with up to 12" clear height above the shelf
- The 18" deep lockers include (2) two-pronged coat hooks, one on each side. The 24" deep lockers include (1) side-to-side coat rod

Part #	Description	Base Price	Laminate Door	E-Lock & Pearl Lock	Nano E-Lock Mini Keypad	Mech Lock	Hasp	Slope Top	Pkg Wt	Pkg Cube
4R28	27-3/4"h x 18"d x 12"w	\$1,202	+\$333	+\$460	+\$320	+\$320	+\$55	+\$304	40 lb	3.9 ft
3X28	27-3/4"h x 18"d x 15"w	\$1,210	+\$385	+\$460	+\$320	+\$320	+\$55	+\$309	45 lb	5.9 ft
3328	34-3/4"h x 18"d x 12"w	\$1,287	+\$353	+\$460	+\$320	+\$320	+\$55	+\$304	46 lb	4.3 ft
4X28	34-3/4"h x 18"d x 15"w	\$1,294	+\$421	+\$460	+\$320	+\$320	+\$55	+\$309	51 lb	7.3 ft
3P28	39-7/8"h x 18"d x 12"w	\$1,367	+\$377	+\$460	+\$320	+\$320	+\$55	+\$304	55 lb	6.5 ft
8P28	39-7/8"h x 24"d x 12"w	\$1,391	+\$377	+\$460	+\$320	+\$320	+\$55	+\$304	66 lb	8.8 ft
5X28	39-7/8"h x 18"d x 15"w	\$1,377	+\$464	+\$460	+\$320	+\$320	+\$55	+\$309	61 lb	8.3 ft
6X28	39-7/8"h x 24"d x 15"w	\$1,411	+\$464	+\$460	+\$320	+\$320	+\$55	+\$309	72 lb	10.7 ft
9P28	39-7/8"h x 18"d x 18"w	\$1,383	+\$523	+\$460	+\$320	+\$320	+\$55	+\$325	64 lb	9.7 ft
7P28	39-7/8"h x 24"d x 18"w	\$1,430	+\$523	+\$460	+\$320	+\$320	+\$55	+\$325	77 lb	12.6 ft
7M28	51-3/8"h x 18"d x 12"w	\$1,659	+\$430	+\$460	+\$320	+\$320	+\$55	+\$304	69 lb	8.24 ft
6M28	51-3/8"h x 24"d x 12"w	\$1,739	+\$430	+\$460	+\$320	+\$320	+\$55	+\$304	83 lb	11 ft
7X28	51-3/8"h x 18"d x 15"w	\$1,667	+\$555	+\$460	+\$320	+\$320	+\$55	+\$309	75 lb	10.4 ft
8X28	51-3/8"h x 24"d x 15"w	\$1,747	+\$555	+\$460	+\$320	+\$320	+\$55	+\$309	90 lb	13.6 ft
1P28	51-3/8"h x 18"d x 18"w	\$1,672	+\$564	+\$460	+\$320	+\$320	+\$55	+\$325	78 lb	12 ft
9N28	51-3/8"h x 24"d x 18"w	\$1,756	+\$564	+\$460	+\$320	+\$320	+\$55	+\$325	89 lb	16.1 ft
1N28	65-7/8"h x 18"d x 12"w	\$1,702	+\$593	+\$460	+\$320	+\$320	+\$55	+\$304	82 lb	11 ft
9M28	65-7/8"h x 24"d x 12"w	\$1,779	+\$593	+\$460	+\$320	+\$320	+\$55	+\$304	100 lb	14.3 ft
9X28	65-7/8"h x 18"d x 15"w	\$1,826	+\$745	+\$460	+\$320	+\$320	+\$55	+\$309	89 lb	13.4 ft
1Y28	65-7/8"h x 24"d x 15"w	\$1,912	+\$745	+\$460	+\$320	+\$320	+\$55	+\$309	108 lb	17.4 ft
8N28	65-7/8"h x 18"d x 18"w	\$1,953	+\$782	+\$460	+\$320	+\$320	+\$55	+\$325	93 lb	15.2 ft
7N28	65-7/8"h x 24"d x 18"w	\$2,046	+\$782	+\$460	+\$320	+\$320	+\$55	+\$325	112 lb	20.4 ft

For customer specified electronic or RFID locks, please call for quote.

Hinge

- L Left
- R Right

Key Locks

See page 11 for available options

Available Fronts

- A Full Pull
- S Satin Nickel Loop
- Q Bar Pull
- E Electronic and Mechanical Locks - see page 47
- V Venting (select A, S, Q pull, or electronic lock)
- M Mail Slot (select A, S, Q pull, or electronic lock)

Note: When selecting E-lock only E or A fronts can be used

Paint & Laminate

See Finish Center for available options

All single wide lockers need to be anchored or ganged together to meet BIFMA stability requirements.



Double Lockers

- Each locker compartment includes (2) two-pronged coat hooks, one per side
- Both doors hinge together, either left or right
- The two locker doors are keyed randomly in the factory
- Optional adjustable shelves may be ordered separately

Part #	Description	Base Price	Laminate Door	E-Lock & Pearl Lock	Nano E-Lock Mini Keypad	Mech Lock	Hasp	Slope Top	Pkg Wt	Pkg Cube
3NH7	2 Door 65-7/8"h x 18"d x 12"w	\$1,929	+\$903	+\$920	+\$640	+\$640	+\$110	+\$304	83 lb	11 ft
2NH7	2-Door 65-7/8"h x 24"d x 12"w	\$2,005	+\$903	+\$920	+\$640	+\$640	+\$110	+\$304	101 lb	14.3 ft
4YH7	2 Door 65-7/8"h x 18"d x 15"w	\$1,999	+\$1,038	+\$920	+\$640	+\$640	+\$110	+\$309	86 lb	13.4 ft
3YH7	2-Door 65-7/8"h x 24"d x 15"w	\$2,080	+\$1,038	+\$920	+\$640	+\$640	+\$110	+\$309	106 lb	17.4 ft
2PH7	2 Door 65-7/8"h x 18"d x 18"w	\$2,012	+\$1,132	+\$920	+\$640	+\$640	+\$110	+\$325	94 lb	15.2 ft
8SH7	2-Door 65-7/8"h x 24"d x 18"w	\$2,093	+\$1,132	+\$920	+\$640	+\$640	+\$110	+\$325	115 lb	20.4 ft

For customer specified electronic or RFID locks, please call for quote.

Hinge

- L Left
- R Right

Key Locks

See page 11 for available options

Available Fronts

- A Full Pull
- S Satin Nickel Loop
- Q Bar Pull
- E Electronic and Mechanical Locks - see page 47
- V Venting (select A, S, Q pull, or electronic lock)
- M Mail Slot (select A, S, Q pull, or electronic lock)

Note: When selecting E-lock only E or A fronts can be used

Paint & Laminate

See Finish Center for available options

All single wide lockers need to be anchored or ganged together to meet BIFMA stability requirements.



TRACE Quad Locker

- Quad lockers do not include shelves. If desired, adjustable shelves may be ordered separately
- Each locker compartment includes (2) two-pronged coat hooks, one per side
- The four locker doors are keyed randomly in the factory
- The four locker doors hinge together, either left or right

Part #	Description	Base Price	Laminate Door	E-Lock & Pearl Lock	Nano E-Lock Mini Keypad	Mech Lock	Hasp	Slope Top	Pkg Wt	Pkg Cube
4NJ7	4 Door 65-7/8"h x 18"d x 24"w	\$2,775	+\$1,807	+\$1,840	+\$1,280	+\$1,280	+\$220	+\$339	142 lb	11 ft
5NJ7	4 Door 65-7/8"h x 24"d x 24"w	\$3,215	+\$1,807	+\$1,840	+\$1,280	+\$1,280	+\$220	+\$339	171 lb	25.5 ft
6YJ7	4 Door 65-7/8"h x 18"d x 30"w	\$2,958	+\$2,080	+\$1,840	+\$1,280	+\$1,280	+\$220	+\$361	155 lb	25.1 ft
5YJ7	4 Door 65-7/8"h x 24"d x 30"w	\$3,426	+\$2,080	+\$1,840	+\$1,280	+\$1,280	+\$220	+\$361	186 lb	32.7 ft

For customer specified electronic or RFID locks, please call for quote.

Hinge

- L Left
- R Right

Key Locks

See page 11 for available options

Available Fronts

- A Full Pull
- S Satin Nickel Loop
- Q Bar Pull
- E Electronic and Mechanical Locks - see page 47
- V Venting (select A, S, Q pull, or electronic lock)
- M Mail Slot (select A, S, Q pull, or electronic lock)

Note: When selecting E-lock only E or A fronts can be used

Paint & Laminate

See Finish Center for available options



TRACE Personal Locker

- 18" wide lockers Includes a fixed shelf on top, two adjustable shelves, pull-out hanging file rack, and coat storage
- Coat compartment includes a single two-pronged hook, located on the hinge side of the locker
- Hanging file rack accommodates 8.25 filing inches

Part #	Description	Base Price	Laminate Door	E-Lock & Pearl Lock	Nano E-Lock Mini Keypad	Mech Lock	Hasp	Slope Top	Pkg Wt	Pkg Cube
6SS7	1 Door 65-7/8"h x 18"d x 18"w	\$2,043	+\$782	+\$460	+\$320	+\$320	+\$55	+\$325	115 lb	20.4 ft

For customer specified electronic or RFID locks, please call for quote.

Hinge

- L Left
- R Right

Key Locks

See page 11 for available options

Available Fronts

- A Full Pull
- S Satin Nickel Loop
- Q Bar Pull
- E Electronic and Mechanical Locks - see page 47
- V Venting (select A, S, Q pull, or electronic lock)
- M Mail Slot (select A, S, Q pull, or electronic lock)

Note: When selecting E-lock only E or A fronts can be used

Paint & Laminate

See Finish Center for available options

All single wide lockers need to be anchored or ganged together to meet BIFMA stability requirements.

Cubby Lockers

- Cubby locker doors are keyed randomly in the factory
- All Cubby locker doors hinge together, either left or right



Part #	Description	Base Price	Laminate Door	E-Lock & Pearl Lock	Nano E-Lock Mini Keypad	Mech Lock	Hasp	Slope Top	Pkg Wt	Pkg Cube
6JT7	2-Door Single 34-3/4" h x 18" d x 12" w	\$1,520	+\$613	+\$920	+\$640	+\$640	+\$110	+\$304	50 lb	5.9 ft
5HT3	3-Door Single 50-3/8" h x 18" d x 12" w	\$1,792	+\$920	+\$1,380	+\$960	+\$960	+\$165	+\$304	70 lb	8.4 ft
3LM7	3-Door Single 65-7/8" h x 18" d x 12" w	\$2,144	+\$1,176	+\$1,380	+\$960	+\$960	+\$165	+\$304	89 lb	11 ft
5JT6	4-Door Single 65-7/8" h x 18" d x 12" w	\$2,194	+\$1,226	+\$1,840	+\$1,280	+\$1,280	+\$220	+\$304	89 lb	11 ft
7YT7	2-Door Single 34-3/4" h x 18" d x 15" w	\$1,619	+\$697	+\$920	+\$640	+\$640	+\$110	+\$309	58 lb	7.2 ft
8YT3	3-Door Single 50-3/8" h x 18" d x 15" w	\$1,911	+\$1,048	+\$1,380	+\$960	+\$960	+\$165	+\$309	77 lb	10.3 ft
7LM7	3-Door Single 65-7/8" h x 18" d x 15" w	\$2,286	+\$1,345	+\$1,380	+\$960	+\$960	+\$165	+\$309	96 lb	13.4 ft
9YT6	4-Door Single 65-7/8" h x 18" d x 15" w	\$2,336	+\$1,395	+\$1,840	+\$1,280	+\$1,280	+\$220	+\$309	96 lb	13.4 ft
9HN7	4-Door Double 34-3/4" h x 18" d x 24" w	\$2,547	+\$1,226	+\$1,840	+\$1,280	+\$1,280	+\$220	+\$339	88 lb	11 ft
8HT1	6 Door Double 50-3/8" h x 18" d x 24" w	\$3,131	+\$1,836	+\$2,760	+\$1,920	+\$1,920	+\$330	+\$339	119 lb	15.7 ft
5LZ7	6-Door Double 65-7/8" h x 18" d x 24" w	\$3,762	+\$2,399	+\$2,760	+\$1,920	+\$1,920	+\$330	+\$339	150 lb	20.5 ft
7HN6	8-Door Double 65-7/8" h x 18" d x 24" w	\$3,812	+\$2,449	+\$3,680	+\$2,560	+\$2,560	+\$440	+\$339	150 lb	20.5 ft
1ZN7	4-Door Double 34-3/4" h x 18" d x 30" w	\$2,715	+\$1,395	+\$1,840	+\$1,280	+\$1,280	+\$220	+\$361	99 lb	13.6 ft
2ZT1	6 Door Double 50-3/8" h x 18" d x 30" w	\$3,335	+\$2,091	+\$2,760	+\$1,920	+\$1,920	+\$330	+\$361	132 lb	19.4 ft
9LZ7	6-Door Double 65-7/8" h x 18" d x 30" w	\$4,010	+\$2,739	+\$2,760	+\$1,920	+\$1,920	+\$330	+\$361	167 lb	25.1 ft
3ZN6	8-Door Double 65-7/8" h x 18" d x 30" w	\$4,060	+\$2,789	+\$3,680	+\$2,560	+\$2,560	+\$440	+\$361	167 lb	25.1 ft

For customer specified electronic or RFID locks, please call for quote.

Hinge

- L Left
- R Right

Key Locks

See page 11 for available options

Available Fronts

- A Full Pull
- S Satin Nickel Loop
- Q Bar Pull
- E Electronic and Mechanical Locks - see page 47
- V Venting (select A, S, Q pull, or electronic lock)
- M Mail Slot (select A, S, Q pull, or electronic lock)

Note: When selecting E-lock only E or A fronts can be used

Paint & Laminate

See Finish Center for available options

All single wide lockers need to be anchored or ganged together to meet BIFMA stability requirements.

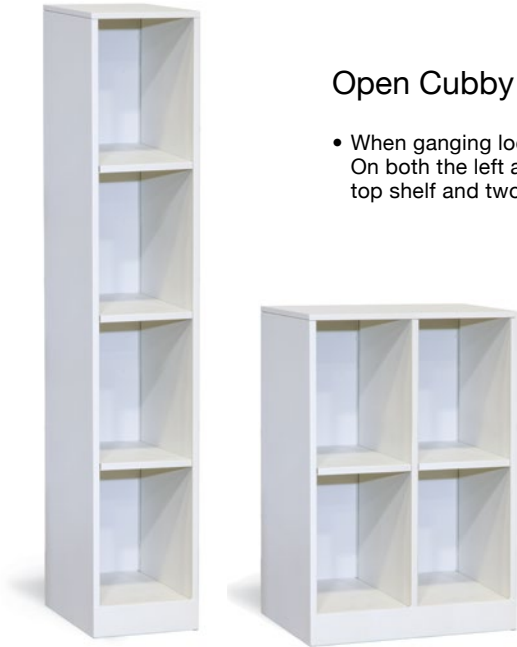

Open Cubby Lockers

- When ganging lockers together side-by-side, use the locator holes provided. On both the left and right sides of the locker, two holes are hidden behind the top shelf and two more are hidden beneath removable bottom pan

Part #	Description	Base Price	Slope Top	Pkg Wt	Pkg Cube
COP7RV5	2-Opening Single Wide 34-3/4"h x 18"d x 12"w	\$1,276	+\$304	45 lb	5.9 ft
COP5HW3	3-Opening Single Wide 50-3/8"h x 18"d x 12"w	\$1,436	+\$304	62 lb	8.4 ft
COP5JW4	4-Opening Single Wide 65-7/8"h x 18"d x 12"w	\$1,710	+\$304	75 lb	11 ft
COP4ZV5	2-Opening Single Wide 34-3/4"h x 18"d x 15"w	\$1,361	+\$309	50 lb	7.2 ft
COP5ZW3	3-Opening Single Wide 50-3/8"h x 18"d x 15"w	\$1,529	+\$309	66 lb	10.3 ft
COP6ZW4	4-Opening Single Wide 65-7/8"h x 18"d x 15"w	\$1,822	+\$309	82 lb	13.4 ft
COP9HW5	4-Opening Double Wide 34-3/4" x 18"d x 24"w	\$2,064	+\$339	80 lb	11 ft
COP8HW6	6-Opening Double Wide 50-3/8" x 18"d x 24"w	\$2,411	+\$339	110 lb	15.7 ft
COP7HW7	8-Opening Double Wide 65-7/8" x 18"d x 24"w	\$2,860	+\$339	135 lb	20.5 ft
COP7ZW5	4-Opening Double Wide 34-3/4" x 18"d x 30"w	\$2,197	+\$361	83 lb	13.6 ft
COP8ZW6	6-Opening Double Wide 50-3/8" x 18"d x 30"w	\$2,569	+\$361	110 lb	19.4 ft
COP9ZW7	8-Opening Double Wide 65-7/8" x 18"d x 30"w	\$3,046	+\$361	137 lb	25.1 ft

Paint & Laminate

See Finish Center for available options

All single wide lockers need to be anchored or ganged together to meet BIFMA stability requirements.



Freestanding and Mobile Mini Locker

- Includes one adjustable shelf

Mobile:

- 37mm black casters, two locking and two non-locking, are field-installed
- Includes a counterweight for stability

Part #	Description	Base Price	Laminate Door	E-Lock & Pearl Lock	Nano E-Lock Mini Keypad	Mech Lock	Hasp	Pkg Wt	Pkg Cube
8D28	Freestanding 20"h x 18-1/4"d x 10"w	\$1,150	+\$130	+\$460	+\$320	+\$320	+\$55	33 lb	3.16 ft
9C28	Mobile 21-3/4"h x 18-1/4"d x 10"w	\$1,200	+\$130	+\$460	+\$320	+\$320	+\$55	33 lb	3.16 ft

For customer specified electronic or RFID locks, please call for quote.

Hinge

- L Left
- R Right

Key Locks

See page 11 for available options

Available Fronts

- A Full Pull
- S Satin Nickel Loop
- Q Bar Pull
- E Electronic and Mechanical Locks - see page 47
- V Venting (select A, S, Q pull, or electronic lock)
- M Mail Slot (select A, S, Q pull, or electronic lock)

Note: When selecting E-lock only E or A fronts can be used

Paint & Laminate

See Finish Center for available options

Locker Accessories

Adjustable Metal Shelves

Part #	Description	Price	Pkg Wt	Pkg Cube
ALT21218	18"D x 12"w Package of 2 with clips	\$306	2.5 lb	1 ft
ALT21224	24"D x 12"w Package of 2 with clips	\$329	4 lb	1.5 ft
ALT21518	18"D x 15"w Package of 2 with clips	\$320	2.5 lb	1 ft
ALT21524	24"D x 15"w Package of 2 with clips	\$344	4 lb	1.5 ft
ALT21818	18"D x 18"w Package of 2 with clips	\$331	3 lb	1.5 ft
ALT21824	24"D x 18"w Package of 2 with clips	\$360	4 lb	1.5 ft
ALT41824	18"D x 12"w Package of 4 with clips	\$378	5 lb	1 ft
ALT42424	24"D x 12"w Package of 4 with clips	\$406	8 lb.	1.5 ft



Locker Bases

Part #	Description	Base Price	Pkg Wt	Pkg Cube
PLN1218	12"W Plinth Base, 9"H x 18"D	\$245	11 lb	1.3 ft
PLN1224	12"W Plinth Base, 9"H x 24"D	\$278	13 lb	1.7 ft
PLN1518	15"W Plinth Base, 9"H x 18"D	\$255	13 lb	1.6 ft
PLN1524	15"W Plinth Base, 9"H x 24"D	\$286	15 lb	2.1 ft
PLN1818	18"W Plinth Base, 9"H x 18"D	\$267	14 lb	1.9 ft
PLN1824	18"W Plinth Base, 9"H x 24"D	\$300	16 lb	2.5 ft
PLN2418	24"W Plinth Base, 9"H x 18"D	\$399	17 lb	2.3 ft
PLN2424	24"W Plinth Base, 9"H x 24"D	\$449	19 lb	3 ft
PLN3018	30"W Plinth Base, 9"H x 18"D	\$421	19 lb	2.8 ft
PLN3024	30"W Plinth Base, 9"H x 24"D	\$474	22 lb	3.8 ft
COPM6P6	12"W Cubby Base, 14-1/2"H x 18"D	\$695	24 lb	2.4 ft
COPM5P6	15"W Cubby Base, 14-1/2H x 18"D	\$740	26 lb	2.9 ft
COPM7P6	24"W Cubby Base, 14-1/2H x 18"D	\$787	32 lb	4.5 ft
COPM8P6	30"W Cubby Base, 14-1/2H x 18"D	\$839	37 lb	5.5 ft

Ojmar

Part #	Description	Price
24501888K	Ojmar Master Key	\$32

Spec Guide Personal Storage Pedestals Lateralis Collab. Islands **Lockers** Lam Lockers Towers Storage Cabinets Bookcases Cayenne Ht Adj Tables Trace Desk Desk Accs Sparkology Terms/Conds



TRACE Locker Ganging Kit

- Ganging kit is used to snug two lockers together so that between-locker seams stay tight
- Ganging kit includes drill point screws and instructions

Part #	Description	Price	Pkg Wt	Pkg Cube
LCK00025K	Kit to gang two lockers together	\$58	1 lb	.2 ft

Locker Door Number Plates



- .030 Acrylic 1" h x 2"w, surface color brushed aluminum
- Imprinted in black with any combination of numbers needed to permanently identify individual locker doors
- Includes a peel-and-stick adhesive (3M #467MP 5 mil PSA) that provides a permanent attachment to metal and laminate
- Shipped separately from your locker order. Once lockers are set in place, the number plates may then be installed in the desired order
- Please specify the quantity and number pattern needed. No minimum order required



Part #	Description	Price per unit
LDNP0012	Brushed aluminum number plate 2" W x 1" H	\$19

Basic Construction

- All Great Openings products meet or exceed applicable ANSI-BIFMA standards for durability and safety
- A 12 year warranty ensures long-lasting performance and after-sale support
- Leveling glides allow for 7/8" adjustment and are accessible from inside the locker
- Concealed door hinges allow for 100 degree opening
- The front-facing kick plate on laminate lockers is 3.25"

Features

- 18" deep lockers include (2) two-pronged coat hooks, one per side
- All single door lockers include two clusters of shelf clip holes in the side panels, to accommodate additional shelves that are sold separately. One cluster near the top of the locker allows for 3" adjustability, with up to 12" clear height above the shelf. A second cluster near the bottom of the locker allows for 3" adjustability, with up to 8" clear height below the shelf
- Additional adjustable shelves are available for order on most locker styles
- Door may hinge left or right
- Lockers available with three lock options: keyed (UM is standard, and also available with LL, SL), Hasp, and electronic locks
- Conventional keyed lockers are keyed randomly at the factory. Key alike service is available

Options and Accessories

- Locker door number plates
- Common laminate tops

Keyed Locks

- Lockers come standard with randomly-assigned UM Series lockers (#226-425)
- UM locks are black-faced, master-keyed and core-removable
- You may arrange with Customer Service to have these locks keyed-alike in the field
- Other key series options are available, including bright nickel LL, Haworth SL

Hasp Locks

- Hasp locks may be used instead of a keyed or electronic lock
- To order, specify "Hasp Lock" in the product description on your purchase order and add \$50 list per door to the keyed locker price

Cleaning Laminate

This guide provides specific information to keep your Great Openings and Sparkeology products like new. With proper care, you can expect years of trouble-free use.

1. Apply a vinegar-and-water solution to a paper towel or a clean, lint-free microfiber cloth.
2. Gently wipe the surface to remove any surface dust. Caution: do not use furniture polish that contains waxes and oils on laminate surfaces. Do not use bleached-based cleaners on laminate as it may discolor. Do not use hard bristle brushes that may scratch the surface.
3. To spot clean laminate, use a mild soap-and-water solution or Windex®.
4. Rub the soiled area in the direction of the grain. If no grain is present, rub in a circular motion.

For customer specified electronic or RFID locks, please call for quote.



E-Lock (E)

- Durable and versatile, electronic locks may be programmed to either fixed or revolving mode
Fixed Mode: Once a code is created, that code remains in effect until the user changes it.
Revolving Mode: Code is cleared after each complete locking cycle.
- Electronic Lock Features:
 - Once a code is entered, the lock is activated by turning the lever to the locked or unlocked position
 - Runs on (2) AAA batteries (included)
 - Operates using a 4-to-8 digit code
 - A supervisor code is included
 - For large projects, the supervisor code may be pre-programmed into locks
 - May be programmed by the supervisor as Fixed or Revolving Code
 - Includes programmable reset features
 - Easy to clean membrane keypad
 - 75,000 plus cycles; extended battery life reduces replacement and labor maintenance costs
- 1 year warranty

Pearl (PR)

- Front loaded batteries; accessible even when locked
- Ultra thin – Pearl has the lowest keypad surface height of any electronic keypad lock
- Features programmable user codes, supervisor code and modes of operation
 - programming is easy and does not require special keys or tools
- 40,000 operating cycles or five years of battery life
- 20 codes per lock: 19 user codes and one supervisor code

Mechanical Lock (OJ)

- Non Handed – Lock fits LH or RH doors
- Key free operation – No need to manage or issue keys to open lock
- Public or Private mode – Lock can be assigned for shared or personal use
- Integrated code finder – Management can recover lost code and reset lock if required
- Lock status indicator – Visually identifies if locker is free or occupied
- Integrated pull handle – Facilitates easy door opening
- Low maintenance – Robust mechanism, no batteries required
- ADA options – Accessories available to assist ADA users
- Key override – Management ability to override all codes with master key
- Interchangeable key cores – Giving ultimate management key control should a key be lost or compromised. Cores are supplied keyed alike.

Nano E-Lock Mini Keypad (WE)

- Access with ADA-compliant keypad or free Wesko App
- All metal construction
- All metal housing
- Brushed nickel finish

TRACE Laminate Locker Inside Dimensions

Description	Height	Interior Dimension Per/Locker Opening				
		12" W	15" W	18" W	18" D	24" D
Single Lockers						
Single Locker 27-3/4"H	23.750	10.32"	13.32	16.32	16.19	22.19
Single Locker 34-3/4"H	30.750	10.32"	13.32	16.32	16.19	22.19
Single Locker 39-7/8"H	35.875"	10.32"	13.32	16.32	16.19	22.19
Single Locker 51-3/8" H	47.375"	10.32"	13.32	16.32	16.19	22.19
Single Locker 65-7/8"H	61.875"	10.32"	13.32	16.32	16.19	22.19
Above Shelf	12.000"	10.32"	13.32	16.32	16.19	22.19
Double Lockers						
Top Locker	30.828"	10.32"	13.32	16.32	16.19	22.19
Bottom Locker	30.279"	10.32"	13.32	16.32	16.19	22.19
Quad Lockers						
Top Lockers	30.828"	10.75"	13.75"	N/A	16.19	22.19
Bottom Lockers	30.279"	10.75"	13.75"	N/A	16.19	22.19
Cubby Lockers						
All Cubbies	14.750"	10.75"	13.75"	N/A	16.19	N/A
Personal Locker						
Personal Locker	61.875"	N/A	N/A	N/A	17.156"	N/A
Above Shelf	12.000"					

Spec Guide Personal Storage Pedestals Laterals Collab. Islands Lockers Lam Lockers Towers Storage Cabinets Bookcases Cayenne Hi Adj Tables Trace Desk Desk Accs Sparkology Terms/Conds



Laminate Single Lockers

- 27-3/4" high lockers include one adjustable shelf, but no coat rod or hooks
- 34-3/4" high locker includes coat hook and slots for adjustable shelves
- 39-7/8" high lockers include coat hooks or rods and optional shelves
- 51-3/8" and 65-7/8" high lockers include one adjustable shelf on top, with up to 12" clear height above the shelf
- The 18" deep lockers include (2) two-pronged coat hooks, one on each side. The 24" deep lockers include (1) side-to-side coat rod

Part #	Description	Base HPL Price	E-Lock & Pearl Lock	Nano E-Lock Mini Keypad	Mech Lock	Hasp	Pkg Wt	Pkg Cube
W4R28	27-3/4"h x 18"d x 12"w	\$1,778	+\$460	+\$320	+\$320	+\$55	40 lb	3.9 ft
W3X28	27-3/4"h x 18"d x 15"w	\$2,087	+\$460	+\$320	+\$320	+\$55	45 lb	5.9 ft
W3328	34-3/4"h x 18"d x 12"w	\$1,847	+\$460	+\$320	+\$320	+\$55	46 lb	4.3 ft
W4X28	34-3/4"h x 18"d x 15"w	\$2,181	+\$460	+\$320	+\$320	+\$55	51 lb	7.3 ft
W3P28	39-7/8"h x 18"d x 12"w	\$1,928	+\$460	+\$320	+\$320	+\$55	55 lb	6.5 ft
W8P28	39-7/8"h x 24"d x 12"w	\$1,964	+\$460	+\$320	+\$320	+\$55	66 lb	8.8 ft
W5X28	39-7/8"h x 18"d x 15"w	\$1,975	+\$460	+\$320	+\$320	+\$55	61 lb	8.3 ft
W6X28	39-7/8"h x 24"d x 15"w	\$2,025	+\$460	+\$320	+\$320	+\$55	72 lb	10.7 ft
W9P28	39-7/8"h x 18"d x 18"w	\$2,020	+\$460	+\$320	+\$320	+\$55	64 lb	9.7 ft
W7P28	39-7/8"h x 24"d x 18"w	\$2,087	+\$460	+\$320	+\$320	+\$55	77 lb	12.6 ft
W7M28	51-3/8"h x 18"d x 12"w	\$2,340	+\$460	+\$320	+\$320	+\$55	69 lb	8.24 ft
W6M28	51-3/8"h x 24"d x 12"w	\$2,447	+\$460	+\$320	+\$320	+\$55	83 lb	11 ft
W7X28	51-3/8"h x 18"d x 15"w	\$2,392	+\$460	+\$320	+\$320	+\$55	75 lb	10.4 ft
W8X28	51-3/8"h x 24"d x 15"w	\$2,506	+\$460	+\$320	+\$320	+\$55	90 lb	13.6 ft
W1P28	51-3/8"h x 18"d x 18"w	\$2,442	+\$460	+\$320	+\$320	+\$55	78 lb	12 ft
W9N28	51-3/8"h x 24"d x 18"w	\$2,563	+\$460	+\$320	+\$320	+\$55	89 lb	16.1 ft
W1N28	65-7/8"h x 18"d x 12"w	\$2,400	+\$460	+\$320	+\$320	+\$55	82 lb	11 ft
W9M28	65-7/8"h x 24"d x 12"w	\$2,507	+\$460	+\$320	+\$320	+\$55	100 lb	14.3 ft
W9X28	65-7/8"h x 18"d x 15"w	\$2,452	+\$460	+\$320	+\$320	+\$55	89 lb	13.4 ft
W1Y28	65-7/8"h x 24"d x 15"w	\$2,746	+\$460	+\$320	+\$320	+\$55	108 lb	17.4 ft
W8N28	65-7/8"h x 18"d x 18"w	\$2,854	+\$460	+\$320	+\$320	+\$55	93 lb	15.2 ft
W7N28	65-7/8"h x 24"d x 18"w	\$2,985	+\$460	+\$320	+\$320	+\$55	112 lb	20.4 ft

For customer specified electronic or RFID locks, please call for quote.

Hinge

- L Left
- R Right

Key Locks

See page 11 for available options

Available Fronts

- S Satin Nickel Loop
- Q Bar Pull
- E Electronic and Mechanical Locks - see page 60

Paint & Laminate

See page 4 for available options

All single wide lockers need to be anchored or ganged together to meet BIFMA stability requirements.



Laminate Double Door Lockers

- Each locker compartment includes (2) two-pronged coat hooks, one per side
- Both doors hinge together, either left or right
- The two locker doors are keyed randomly in the factory
- Optional adjustable shelves may be ordered separately

Part #	Description	Base HPL Price	E-Lock & Pearl Lock	Nano E-Lock Mini Keypad	Mech Lock	Hasp	Pkg Wt	Pkg Cube
W3NH7	2 Door 65-7/8"h x 18"d x 12"w	\$2,758	+\$920	+\$640	+\$640	+\$110	83 lb	11 ft
W2NH7	2-Door 65-7/8"h x 24"d x 12"w	\$2,868	+\$920	+\$640	+\$640	+\$110	101 lb	14.3 ft
W4YH7	2 Door 65-7/8"h x 18"d x 15"w	\$2,870	+\$920	+\$640	+\$640	+\$110	86 lb	13.4 ft
W3YH7	2-Door 65-7/8"h x 24"d x 15"w	\$2,984	+\$920	+\$640	+\$640	+\$110	106 lb	17.4 ft
W2PH7	2 Door 65-7/8"h x 18"d x 18"w	\$2,982	+\$920	+\$640	+\$640	+\$110	94 lb	15.2 ft
W8SH7	2-Door 65-7/8"h x 24"d x 18"w	\$3,099	+\$920	+\$640	+\$640	+\$110	115 lb	20.4 ft

For customer specified electronic or RFID locks, please call for quote.

Hinge
L Left
R Right

Key Locks
See page 11 for available options

Available Fronts
S Satin Nickel Loop
Q Bar Pull
E Electronic and Mechanical Locks - see page 60

Paint & Laminate
See page 4 for available options

All single wide lockers need to be anchored or ganged together to meet BIFMA stability requirements.



Laminate Z Lockers

- Each locker compartment includes a two-pronged coat hook and adjustable shelf
- Both doors hinge together, either left or right
- The two locker doors are keyed randomly in the factory

Part #	Description	Base HPL Price	E-Lock & Pearl Lock	Nano E-Lock Mini Keypad	Mech Lock	Hasp	Pkg Wt	Pkg Cube
WR9XZ2	Upper door right hinge 65-7/8"h x 18"d x 15"w	\$3,224	+\$920	+\$640	+\$640	+\$110	86 lb	13.4 ft
WL9XZ2	Upper door left hinge 65-7/8"h x 18"d x 15"w	\$3,224	+\$920	+\$640	+\$640	+\$110	86 lb	13.4 ft

Hinge
L Left
R Right

Key Locks
See page 11 for available options

Available Fronts
S Satin Nickel Loop
Q Bar Pull
E Electronic and Mechanical Locks - see page 60

Paint & Laminate
See page 4 for available options

All single wide lockers need to be anchored or ganged together to meet BIFMA stability requirements.



Laminate Quad Lockers

- Quad lockers do not include shelves. If desired, adjustable shelves may be ordered separately
- Each locker compartment includes (2) two-pronged coat hooks, one per side
- The four locker doors are keyed randomly in the factory
- The four locker doors hinge together, either left or right

Part #	Description	Base HPL Price	E-Lock & Pearl Lock	Nano E-Lock Mini Keypad	Mech Lock	Hasp	Pkg Wt	Pkg Cube
W4NJ7	4 Door 65-7/8"h x 18"d x 24"w	\$3,914	+\$1,840	+\$1,280	+\$1,280	+\$220	142 lb	11 ft
W5NJ7	4 Door 65-7/8"h x 24"d x 24"w	\$4,774	+\$1,840	+\$1,280	+\$1,280	+\$220	171 lb	25.5 ft
W6YJ7	4 Door 65-7/8"h x 18"d x 30"w	\$5,277	+\$1,840	+\$1,280	+\$1,280	+\$220	155 lb	25.1 ft
W5YJ7	4 Door 65-7/8"h x 24"d x 30"w	\$5,555	+\$1,840	+\$1,280	+\$1,280	+\$220	186 lb	32.7 ft

Hinge

- L Left
- R Right

Key Locks

See page 11 for available options

Available Fronts

- S Satin Nickel Loop
- Q Bar Pull
- E Electronic and Mechanical Locks - see page 60

Paint & Laminate

See page 4 for available options

All single wide lockers need to be anchored or ganged together to meet BIFMA stability requirements.

Laminate Cubby Lockers

- Cubby locker doors are keyed randomly in the factory
- All Cubby locker doors hinge together, either left or right



Part #	Description	Base HPL Price	E-Lock & Pearl Lock	Nano E-Lock Mini Keypad	Mech Lock	Hasp	Pkg Wt	Pkg Cube
W6JT7	2-Door Single 34-3/4"h x 18"d x 12"w	\$2,143	+\$920	+\$640	+\$640	+\$110	50 lb	5.9 ft
W5HT3	3-Door Single 50-3/8"h x 18"d x 12"w	\$2,528	+\$1,380	+\$960	+\$960	+\$165	70 lb	8.4 ft
W5JT6	4-Door Single 65-7/8"h x 18"d x 12"w	\$3,091	+\$1,840	+\$1,280	+\$1,280	+\$220	89 lb	11 ft
W7YT7	2-Door Single 34-3/4"h x 18"d x 15"w	\$2,460	+\$920	+\$640	+\$640	+\$110	58 lb	7.2 ft
W8YT3	3-Door Single 50-3/8"h x 18"d x 15"w	\$2,828	+\$1,380	+\$960	+\$960	+\$165	77 lb	10.3 ft
W9YT6	4-Door Single 65-7/8"h x 18"d x 15"w	\$3,664	+\$1,840	+\$1,280	+\$1,280	+\$220	96 lb	13.4 ft
W9HN7	4-Door Double 34-3/4"h x 18"d x 24"w	\$3,336	+\$1,840	+\$1,280	+\$1,280	+\$220	88 lb	11 ft
W8HT1	6 Door Double 50-3/8"h x 18"d x 24"w	\$4,097	+\$2,760	+\$1,920	+\$1,920	+\$330	119 lb	15.7 ft
W7HN6	8-Door Double 65-7/8"h x 18"d x 24"w	\$4,990	+\$3,680	+\$2,560	+\$2,560	+\$440	150 lb	20.5 ft
W1ZN7	4-Door Double 34-3/4"h x 18"d x 30"w	\$3,403	+\$1,840	+\$1,280	+\$1,280	+\$220	99 lb	13.6 ft
W2ZT1	6 Door Double 50-3/8"h x 18"d x 30"w	\$4,526	+\$2,760	+\$1,920	+\$1,920	+\$330	132 lb	19.4 ft
W3ZN6	8-Door Double 65-7/8"h x 18"d x 30"w	\$5,629	+\$3,680	+\$2,560	+\$2,560	+\$440	167 lb	25.1 ft

Hinge
L Left
R Right

Key Locks
See page 11 for available options

Available Fronts
S Satin Nickel Loop
Q Bar Pull
E Electronic and Mechanical Locks - see page 60

Paint & Laminate
See page 4 for available options

All single wide lockers need to be anchored or ganged together to meet BIFMA stability requirements.

Open Cubby Lockers

- When ganging lockers together side-by-side, use the locator holes provided. On both the left and right sides of the locker, two holes are hidden behind the top shelf and two more are hidden beneath removable bottom pan
- Laminate Lockers, both 12" & 18" wide, require anchoring or ganging to meet BIFMA stability requirements



Part #	Description	Base HPL Price	Pkg Wt	Pkg Cube
WCOP7RV5	2-Opening Single Wide 34-3/4"h x 18"d x 12"w	\$1,831	45 lb	5.9 ft
WCOP5HW3	3-Opening Single Wide 50-3/8"h x 18"d x 12"w	\$2,101	62 lb	8.4 ft
WCOP5JW4	4-Opening Single Wide 65-7/8"h x 18"d x 12"w	\$2,476	75 lb	11 ft
WCOP4ZV5	2-Opening Single Wide 34-3/4"h x 18"d x 15"w	\$2,030	50 lb	7.2 ft
WCOP5ZW3	3-Opening Single Wide 50-3/8"h x 18"d x 15"w	\$2,308	66 lb	10.3 ft
WCOP6ZW4	4-Opening Single Wide 65-7/8"h x 18"d x 15"w	\$2,644	82 lb	13.4 ft
WCOP9HW5	4-Opening Double Wide 34-3/4"h x 18"d x 24"w	\$2,767	80 lb	11 ft
WCOP8HW6	6-Opening Double Wide 50-3/8"h x 18"d x 24"w	\$3,457	110 lb	15.7 ft
WCOP7HW7	8-Opening Double Wide 65-7/8"h x 18"d x 24"w	\$4,156	135 lb	20.5 ft
WCOP7ZW5	4-Opening Double Wide 34-3/4"h x 18"d x 30"w	\$2,828	83 lb	13.6 ft
WCOP8ZW6	6-Opening Double Wide 50-3/8"h x 18"d x 30"w	\$3,849	110 lb	19.4 ft
WCOP9ZW7	8-Opening Double Wide 65-7/8"h x 18"d x 30"w	\$4,257	137 lb	25.1 ft

Laminate

See page 4 for available options

All single wide lockers need to be anchored or ganged together to meet BIFMA stability requirements.

Laminate Locker Accessories

Adjustable Laminate Shelves

Part #	Description	Base HPL Price	Pkg Wt	Pkg Cube
WALT21218	18"D x 12"w Package of 2 with clips	\$409	2.5 lb	1 ft
WALT21224	24"D x 12"w Package of 2 with clips	\$439	4 lb	1.5 ft
WALT21518	18"D x 15"w Package of 2 with clip	\$426	2.5 lb	1 ft
WALT21524	24"D x 15"w Package of 2 with clips	\$457	4 lb	1.5 ft
WALT21818	18"D x 18"w Package of 2 with clips	\$444	3 lb	1.5 ft
WALT21824	24"D x 18"w Package of 2 with clips	\$479	4 lb	1.5 ft
WALT22418	18"D x 24"w Package of 2 with clips	\$479	4 lb	1.5 ft
WALT22424	24"D x 24"w Package of 2 with clips	\$439	4 lb	1.5 ft
WALT23018	18"D x 30"w Package of 2 with clips	\$426	4 lb	1.5 ft
WALT23024	24"D x 30"w Package of 2 with clips	\$457	4 lb	1.5 ft

Ojmar

Part #	Description	Price
24501888K	Ojmar Master Key	\$32

Laminate Locker Ganging Kit

- Ganging kit is used to snug two lockers together so that between-locker seams stay tight
- Ganging kit includes drill point screws and instructions



Part #	Description	Price	Pkg Wt	Pkg Cube
WLCK00025K	Kit to gang two lockers together	\$58	1 lb	.2 ft

Common Laminate Tops

- Laminate tops ordered separately for field installation
- Specify any standard GO laminate or special ordered laminate
- Top sizes allow for 1/8" overhang on all sides
- Common laminate tops will sit on top of locker's metal tops

Laminate Top for Side-by-Side Lockers



Part #	Description	W	D	Price	Pkg Wt	Pkg Cube
LK 1848	(4) 12" wide x 18" deep lockers	48.50	18.25	\$547	38 lb	.7 ft
LK 1854	(3) 18" wide x 18" deep lockers	54.43	18.25	\$639	42 lb	.8 ft
LK 1860	(5) 12" wide x 18" deep lockers	60.56	18.25	\$645	46 lb	.9 ft
LK 2448	(4) 12" wide x 24" deep lockers	48.50	24.25	\$627	41 lb	1.0 ft
LK 2454	(3) 18" wide x 24" deep lockers	54.43	24.25	\$728	45 lb	1.1 ft
LK 2460	(5) 12" wide x 24" deep lockers	60.56	24.25	\$743	50 lb	1.2 ft

Laminate Top for Side-by-Side Double Wide Cubby Lockers



Part #	Description	W	D	Price	Pkg Wt	Pkg Cube
LK 1848	(2) 24" wide x 18" deep lockers	48.50	18.25	\$547	38 lb	.7 ft
LK 1872	(3) 24" wide x 18" deep lockers	72.43	18.25	\$876	64 lb	1.3 ft
LK 1896	(4) 24" wide x 18" deep lockers	96.50	18.25	\$1,027	95 lb	1.6 ft

Laminate Top for Side-by-Side Open Lockers

- Open Shelf Cubby Lockers require a different size laminate top because they have no doors



Part #	Description	W	D	Price	Pkg Wt	Pkg Cube
LK 1724	(2) 12" wide x 18" deep open cubby lockers (no doors)	24.37	17.50	\$382	19 lb	.5 ft
LK 1748	(4) 12" wide x 18" deep open cubby lockers (no doors)	48.50	17.50	\$541	38 lb	.7 ft
LK 1760	(5) 12" wide x 18" deep open cubby lockers (no doors)	60.56	17.50	\$640	46 lb	.9 ft
LK 1796	(4) 24" wide x 18" deep open cubby lockers (no doors)	96.50	17.50	\$1,020	95 lb	1.6 ft

Laminate Top for Side-by-Side Double Wide Open Cubby Lockers



Part #	Description	W	D	Price	Pkg Wt	Pkg Cube
LK 1748	(2) 24" wide x 18" deep open cubby lockers (no doors)	48.50	17.50	\$541	41 lb	.8 ft
LK 1772	(3) 24" wide x 18" deep open cubby lockers (no doors)	72.43	17.50	\$868	64 lb	1.3 ft
LK 1796	(4) 24" wide x 18" deep open cubby lockers (no doors)	96.50	17.50	\$1,020	95 lb	1.6 ft

Laminate Top for Bar-Height Island with Lockers

- 39-7/8" h lockers with 12" overhang and Sly chair. Sides and front overhang 1/8"



Part #	Description	W	D	Price	Pkg Wt	Pkg Cube
LK 3048	(4) 12" wide x 18" deep lockers (includes 12" overhang in back)	48.25	30.25	\$702	51 lb	1.0 ft
LK 3054	(3) 18" wide x 18" deep lockers (includes 12" overhang in back)	54.25	30.25	\$817	58 lb	1.2 ft
LK 3060	(5) 12" wide x 18" deep lockers (includes 12" overhang in back)	60.25	30.25	\$839	63 lb	1.4 ft

trace SINGLE DOOR LOCKER
MULTIPLE COLOR DOOR INDICATION FORM



Use this form to indicate what custom colors you would like on your Single Door Locker. Use additional forms if needed for different color configurations.

1. Use the diagram below to indicate (type or write in) which colors go on which doors and case.
2. Email this form along with your purchase order to customer service at goorders@greatopenings.com.

Calculating Multiple Color Paint Charges:

For each unique cabinet, add \$55 net per additional color beyond the case color. When ordering multiple cabinets that are identical in color pattern, the \$55 net per additional color is applied just once.

Example:	
Case Color plus 1 additional color	\$55 net

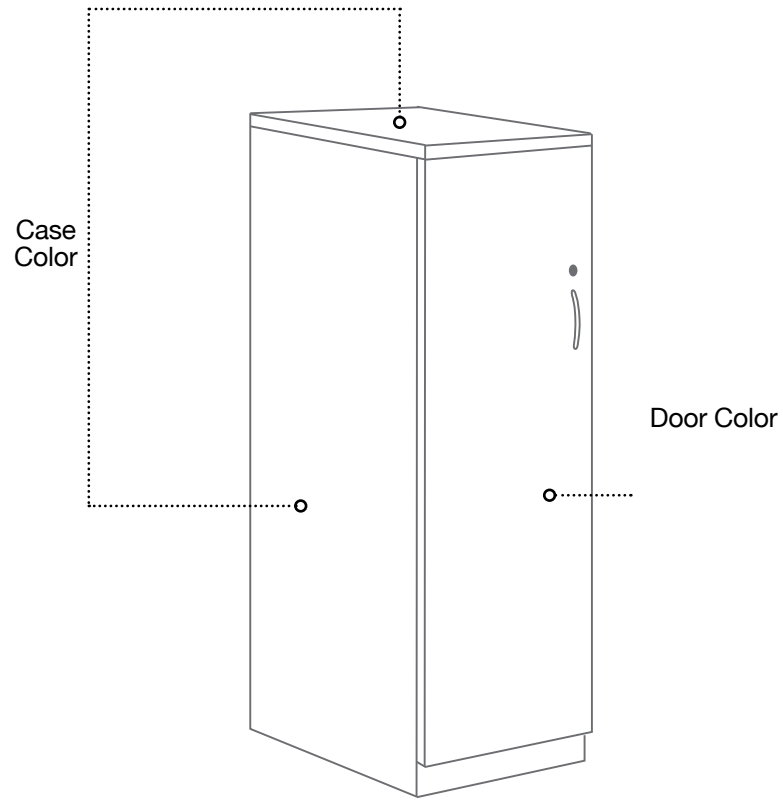

DOUBLE DOOR LOCKER

trace MULTIPLE COLOR DOOR INDICATION FORM



Use this form to indicate what custom colors you would like on your Double Door Locker. Use additional forms if needed for different color configurations.

1. Use the diagram below to indicate (type or write in) which colors go on which doors and case.
2. Email this form along with your purchase order to customer service at goorders@greatopenings.com.

Calculating Multiple Color Paint Charges:

For each unique cabinet, add \$55 net per additional color beyond the case color. When ordering multiple cabinets that are identical in color pattern, the \$55 net per additional color is applied just once.

Example:

Case Color plus 1 additional color	\$55 net
Case Color plus 2 additional colors	\$110 net

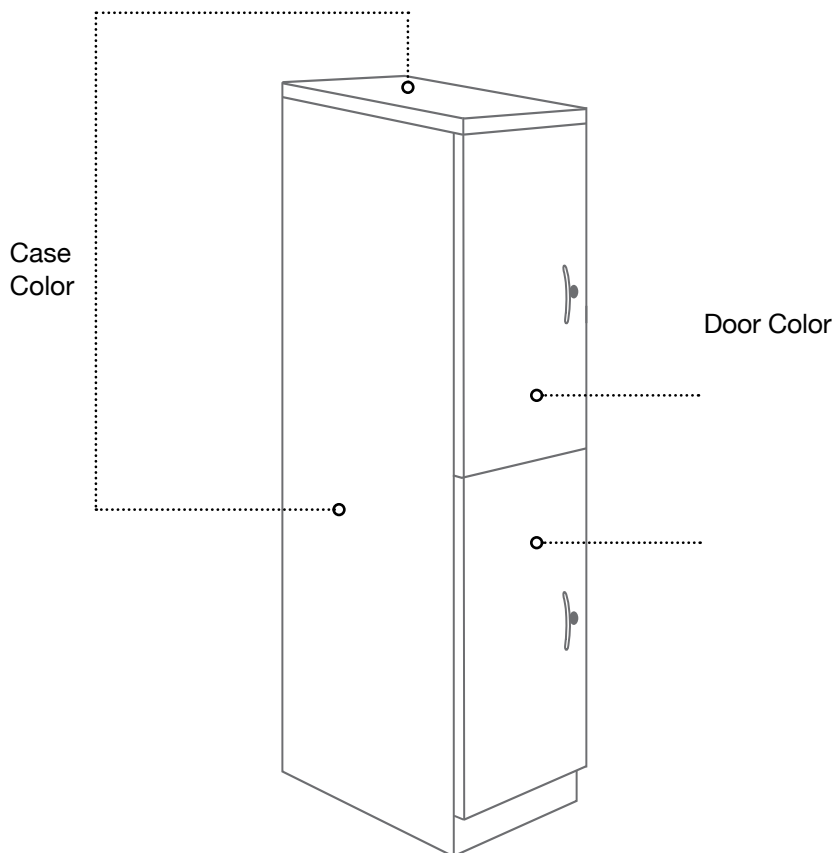

trace **QUAD LOCKER**
MULTIPLE COLOR DOOR INDICATION FORM



Use this form to indicate what custom colors you would like on your Quad Locker. Use additional forms if needed for different color configurations.

1. Use the diagram below to indicate (type or write in) which colors go on which doors and case.
2. Email this form along with your purchase order to customer service at goorders@greatopenings.com.

Calculating Multiple Color Paint Charges:

For each unique cabinet, add \$55 net per additional color beyond the case color. When ordering multiple cabinets that are identical in color pattern, the \$55 net per additional color is applied just once.

Example:	
Case Color plus 1 additional color	\$55 net
Case Color plus 2 additional colors	\$110 net
Case Color plus 3 additional colors	\$165 net
Case Color plus 4 additional colors	\$220 net

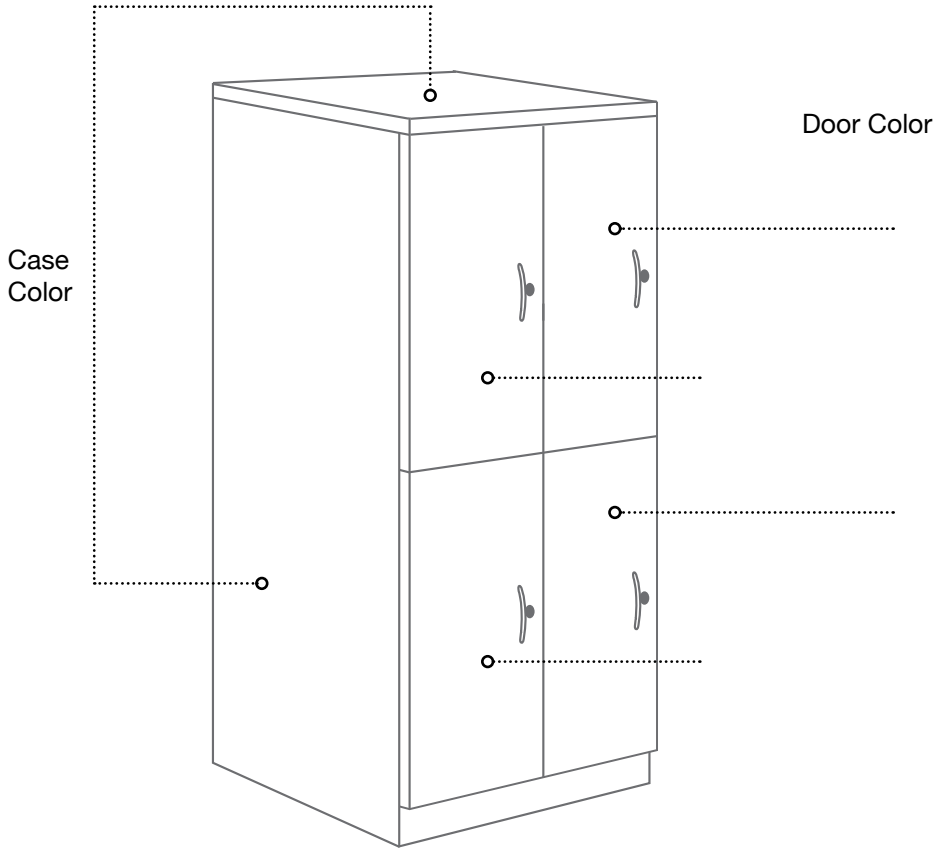

trace SINGLE WIDE 2-DOOR CUBBY LOCKER
MULTIPLE COLOR DOOR INDICATION FORM



Use this form to indicate what custom colors you would like on your Single Wide 2-Door Cubby locker. Use additional forms if needed for different color configurations.

1. Use the diagram below to indicate (type or write in) which colors go on which doors and case.
2. Email this form along with your purchase order to customer service at goorders@greatopenings.com.

Calculating Multiple Color Paint Charges:

For each unique cabinet, add \$55 net per additional color beyond the case color. When ordering multiple cabinets that are identical in color pattern, the \$55 net per additional color is applied just once.

Example:

Case Color plus 1 additional color	\$55 net
Case Color plus 2 additional colors	\$110 net

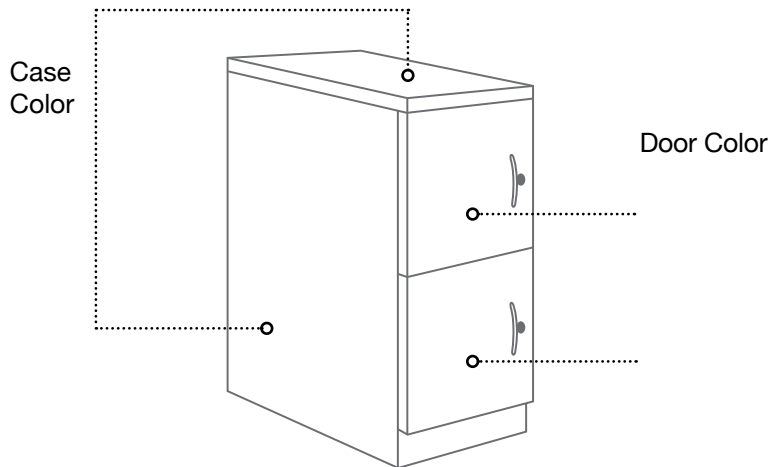

trace SINGLE WIDE 3-DOOR CUBBY LOCKER
MULTIPLE COLOR DOOR INDICATION FORM



Use this form to indicate what custom colors you would like on your Single Wide 3-Door Cubby locker. Use additional forms if needed for different color configurations.

1. Use the diagram below to indicate (type or write in) which colors go on which doors and case.
2. Email this form along with your purchase order to customer service at goorders@greatopenings.com.

Calculating Multiple Color Paint Charges:

For each unique cabinet, add \$55 net per additional color beyond the case color. When ordering multiple cabinets that are identical in color pattern, the \$55 net per additional color is applied just once.

Example:	
Case Color plus 1 additional color	\$55 net
Case Color plus 2 additional colors	\$110 net
Case Color plus 3 additional colors	\$165 net

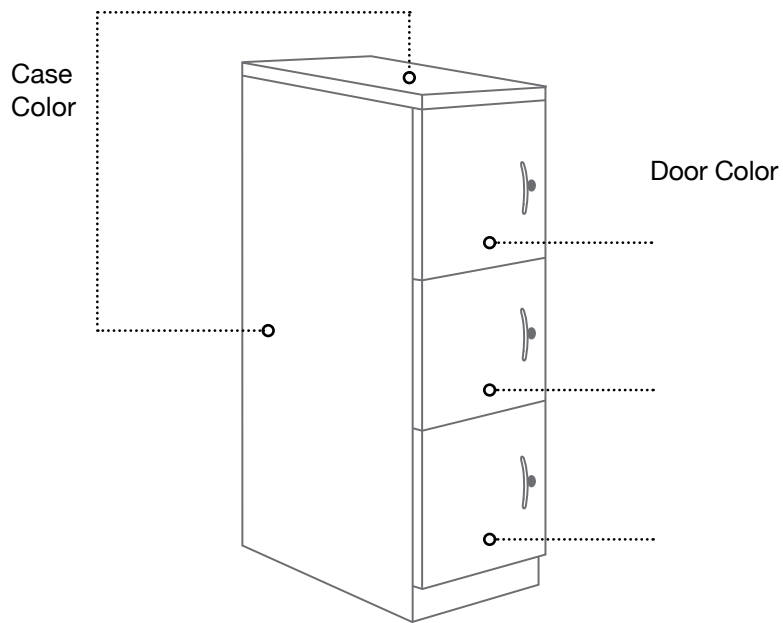

trace SINGLE WIDE 4-DOOR CUBBY LOCKER
MULTIPLE COLOR DOOR INDICATION FORM



Use this form to indicate what custom colors you would like on your Single Wide 4-Door Cubby locker. Use additional forms if needed for different color configurations.

1. Use the diagram below to indicate (type or write in) which colors go on which doors and case.
2. Email this form along with your purchase order to customer service at goorders@greatopenings.com.

Calculating Multiple Color Paint Charges:

For each unique cabinet, add \$55 net per additional color beyond the case color. When ordering multiple cabinets that are identical in color pattern, the \$55 net per additional color is applied just once.

Example:	
Case Color plus 1 additional color	\$55 net
Case Color plus 2 additional colors	\$110 net
Case Color plus 3 additional colors	\$165 net
Case Color plus 4 additional colors	\$220 net

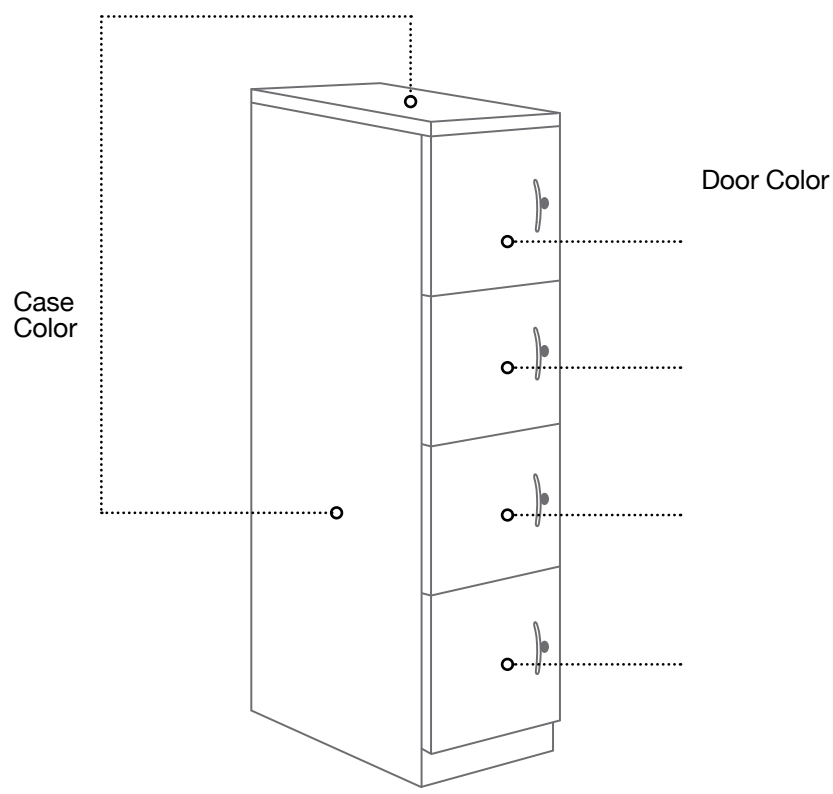

DOUBLE WIDE 4-DOOR CUBBY LOCKER
MULTIPLE COLOR DOOR INDICATION FORM



Use this form to indicate what custom colors you would like on your Double Wide 4-Door Cubby Locker. Use additional forms if needed for different color configurations.

1. Use the diagram below to indicate (type or write in) which colors go on which doors and case.
2. Email this form along with your purchase order to customer service at goorders@greatopenings.com.

Calculating Multiple Color Paint Charges:

For each unique cabinet, add \$55 net per additional color beyond the case color. When ordering multiple cabinets that are identical in color pattern, the \$55 net per additional color is applied just once.

Example:	
Case Color plus 1 additional color	\$55 net
Case Color plus 2 additional colors	\$110 net
Case Color plus 3 additional colors	\$165 net
Case Color plus 4 additional colors	\$220 net

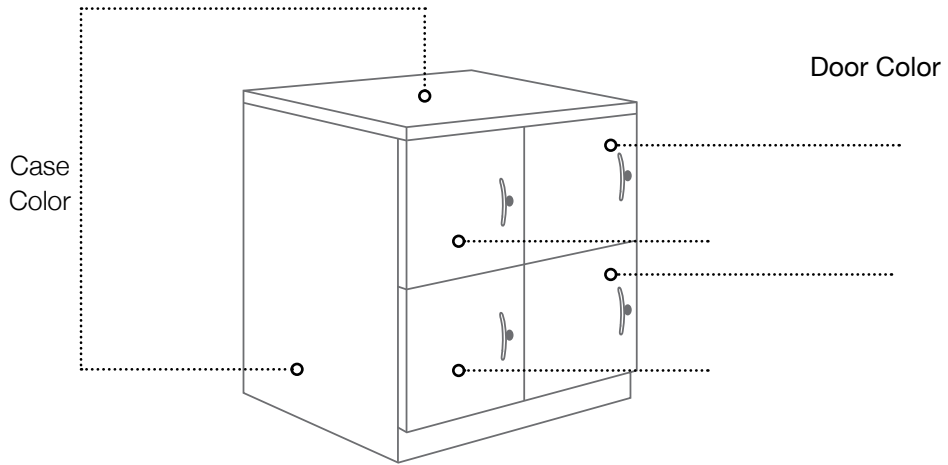

DOUBLE WIDE 6-DOOR CUBBY LOCKER
trace MULTIPLE COLOR DOOR INDICATION FORM



Use this form to indicate what custom colors you would like on your Double Wide 6-Door Cubby Locker. Use additional forms if needed for different color configurations.

1. Use the diagram below to indicate (type or write in) which colors go on which doors and case.
2. Email this form along with your purchase order to customer service at goorders@greatopenings.com.

Calculating Multiple Color Paint Charges:

For each unique cabinet, add \$55 net per additional color beyond the case color. When ordering multiple cabinets that are identical in color pattern, the \$55 net per additional color is applied just once.

Example:	
Case Color plus 1 additional color	\$55 net
Case Color plus 2 additional colors	\$110 net
Case Color plus 3 additional colors	\$165 net
Case Color plus 4 additional colors	\$220 net
Case Color plus 5 additional colors	\$275 net
Case Color plus 6 additional colors	\$330 net

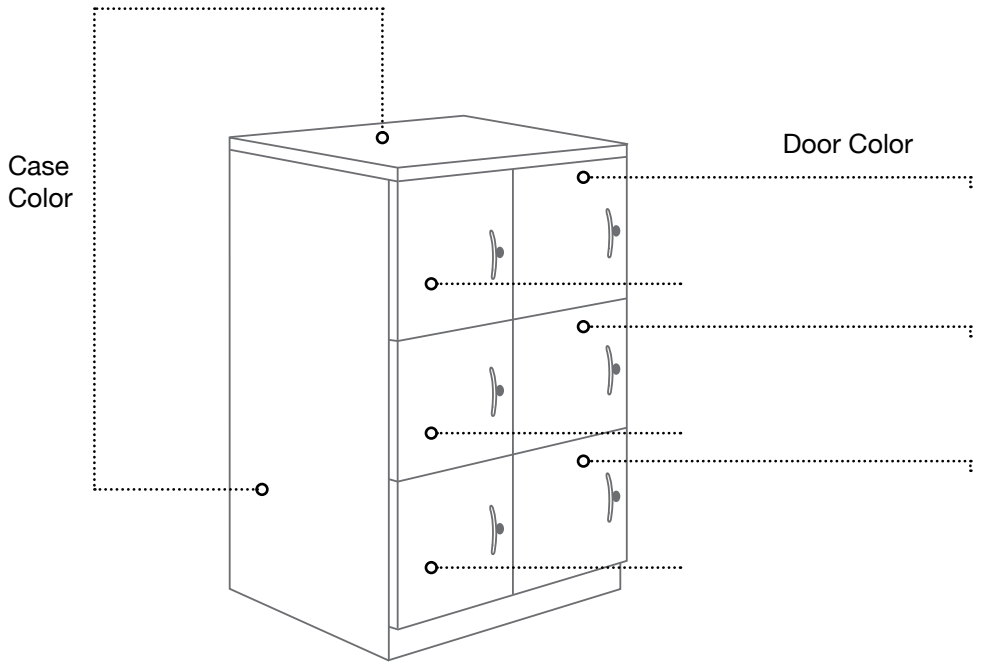

DOUBLE WIDE 8-DOOR CUBBY LOCKER
MULTIPLE COLOR DOOR INDICATION FORM

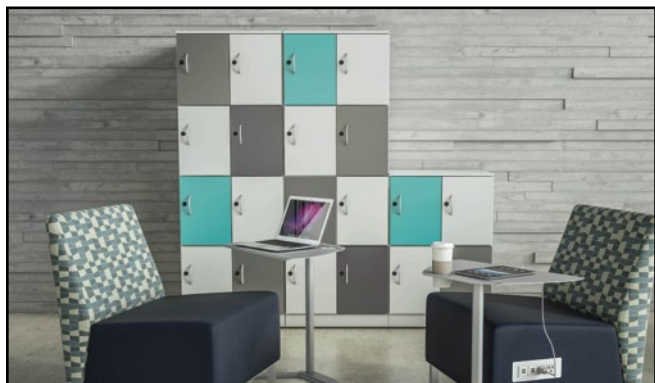

Use this form to indicate what custom colors you would like on your Double Wide 8-Door Cubby Locker. Use additional forms if needed for different color configurations.

1. Use the diagram below to indicate (type or write in) which colors go on which doors and case.
2. Email this form along with your purchase order to customer service at goorders@greatopenings.com.

Calculating Multiple Color Paint Charges:

For each unique cabinet, add \$55 net per additional color beyond the case color. When ordering multiple cabinets that are identical in color pattern, the \$55 net per additional color is applied just once.

Example:	
Case Color plus 1 additional color	\$55 net
Case Color plus 2 additional colors	\$110 net
Case Color plus 3 additional colors	\$165 net
Case Color plus 4 additional colors	\$220 net
Case Color plus 5 additional colors	\$275 net
Case Color plus 6 additional colors	\$330 net
Case Color plus 7 additional colors	\$385 net
Case Color plus 8 additional colors	\$440 net

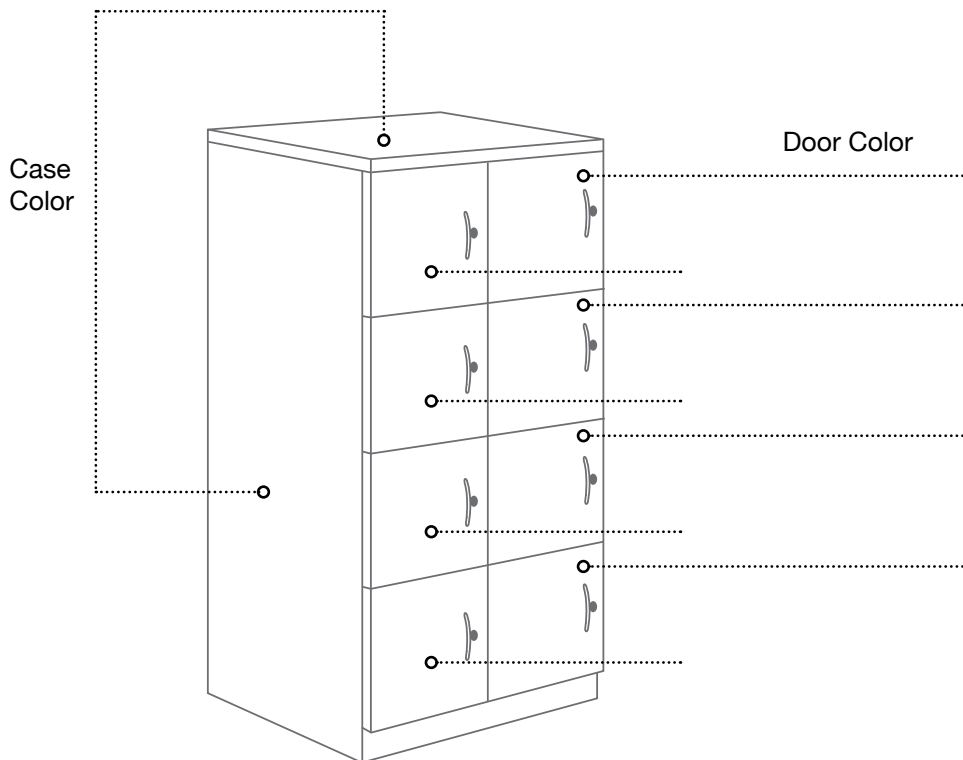



Basic Construction

- All Great Openings products meet or exceed applicable ANSI-BIFMA standards for durability and safety
- Welded steel frame construction and formed channels ensure strength in key areas
- Reinforced vertical and horizontal channels ensure dimensional stability
- Top, back, side and center panels are 21 gauge steel
- Inner top, bottom, and side channels are 18 gauge steel
- Drawer and door fronts are 20-22 gauge steel
- Shelves are 18 gauge steel, and drawer bins are 22 gauge
- Concealed hinges allow for 110° opening
- Shelves are ¾" tall and are adjustable in 1-1/2" increments
- Four leveling glides with 7/8" adjustment ensure proper alignment and operation, and are accessible from inside the cabinet
- Mobile Cupboard Wardrobe Tower includes 75mm casters, two locking and two non-locking
- Tower drawers include full-extension steel ball-bearing slides, with anti-rebound and quick disconnect features
- The front-facing kick plate on Trace towers is 3.25" high

Features

- Laminate fronts may be specified for 2-high and 3-high double door storage cabinets and cupboard wardrobe towers

Options and Accessories

- All options and accessories are sold separately or are available as an upgrade
- In towers, file drawer dividers allow for side-to-side filing
- Work Surface Support Bracket attaches to the Bookcase Wardrobe Tower or Bookcase Tower

Lock System

- Keyed locks include randomly-assigned UM Series locks
- UM locks are black-faced, master-keyed, and core-removable
- Locks may be keyed-alike in the field
- Other key series are available, including Haworth SL, bright nickel LL, and Knoll K. See the Specification Guide for details and how to order
- Towers include safety interlock that allows only one drawer to open at a time
- Towers are not available with individually locking doors/drawers

Can I customize?

- Towers with special heights, widths, depths, and drawer/cupboard configurations are one of our specialties! Call for details

Trace Towers and Storage File Inside Dimensions (in inches)

	Inner Height	Inner Width	Inner Depth
Coat Closets - All Towers			
Coat closet in 65-7/8" tower	61.070"	6.000"	22.750"
Coat closet in 56" tower	51.236"	6.000"	22.750"
Coat closet in 51-3/8" tower	46.575"	6.000"	22.750"
Coat closet in 46" tower	41.112"	6.000"	22.750"
Coat closet in 39-7/8" tower	35.000"	6.000"	22.750"
Cupboards - All Towers			
Tall Cupboard in 65-7/8" tower	37.250"	12.500"	22.750"
Short Cupboard in 65-7/8" tower	25.938"	12.500"	22.750"
Cupboard in 56" tower	27.650"	12.500"	22.750"
Tall Cupboard in 51-3/8" tower	22.800"	12.500"	22.750"
Short Cupboard in 51-3/8" tower	11.541"	12.500"	22.750"
Cupboard in 46" tower	17.291"	12.500"	22.750"
Cupboard in 39-7/8" tower	11.630"	12.500"	22.750"
Bookcases - All Towers			
Bookcase in 65-7/8" tower	36.000"	21.500"	15.000"
Bookcase in 56" tower	26.497"	21.500"	15.000"
Bookcase in 51-3/8" tower	21.500"	21.500"	15.000"
Bookcase in 46" tower	16.376"	21.500"	15.000"
Drawers and Shelves - All Towers			
Bookcase in 65-7/8" tower	5.1"	26.7"	15.000"
Box Drawer	4.500"	12.125"	18.810"
File Drawer	9.500"	12.125"	18.810"
Adjustable shelf thickness	1.000"		

TRACE Cupboard Wardrobe Tower



- Single lock captures all doors and drawers
- Coat closet includes side-to-side coat rod
- 39-7/8" tower: no adjustable shelf
- 46" tower: no adjustable shelf
- 51-3/8" tower w/ 24.5" cupboard: one adjustable shelf
- 51-3/8" tower w/ 13" cupboard: no adjustable shelf
- 56" tower: one adjustable shelf
- 65-7/8" tower w/ 39" cupboard: two adjustable shelves
- 65-7/8" tower w/ 27" cupboard: one adjustable shelf

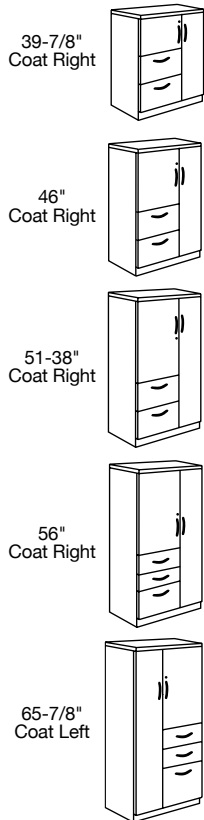

H	D	W	Coat Door	Drawer Options	Pkg Wt	Pkg Cube	Part #	Front	Part #	Metal Color	Price
39-7/8	23-1/2	23-1/2	left	2 file drawers, 13" cupboard	136 lb	18.0 ft	DG	?	A354	?	\$3,110
			left	2 box/1 file drawer, 13" cupboard	139 lb	18.0 ft	DG	?	A338	?	\$3,166
39-7/8	23-1/2	23-1/2	right	2 file drawers, 13" cupboard	136 lb	18.0 ft	WG	?	A354	?	\$3,110
			right	2 box/1 file drawer, 13" cupboard	139 lb	18.0 ft	WG	?	A338	?	\$3,166
46	23-1/2	23-1/2	left	2 file drawers, 19" cupboard	150 lb	19.5 ft	DG	?	4454	?	\$3,189
			left	2 box/1 file drawer, 19" cupboard	153 lb	19.5 ft	DG	?	4472	?	\$3,385
46	23-1/2	23-1/2	right	2 file drawers, 19" cupboard	150 lb	19.5 ft	WG	?	4454	?	\$3,189
			right	2 box/1 file drawer, 19" cupboard	153 lb	19.5 ft	WG	?	4472	?	\$3,385
51-3/8	23-1/2	23-1/2	left	2 file drawers, 24.5" cupboard	164 lb	21.0 ft	DG	?	J654	?	\$3,265
			left	2 box/1 file drawer, 24.5" cupboard	167 lb	21.0 ft	DG	?	J672	?	\$3,386
			left	3 file drawers, 13" cupboard	175 lb	21.0 ft	DG	?	J652	?	\$3,487
51-3/8	23-1/2	23-1/2	right	2 file drawers, 24.5" cupboard	164 lb	21.0 ft	WG	?	J654	?	\$3,265
			right	2 box/1 file drawer, 24.5" cupboard	167 lb	21.0 ft	WG	?	J672	?	\$3,386
			right	3 file drawers, 13" cupboard	175 lb	21.0 ft	WG	?	J652	?	\$3,487
56	23-1/2	23-1/2	left	2 file drawers, 29" cupboard	178 lb	23 ft	DG	?	A754	?	\$3,277
			left	2 box/1 file drawer, 29" cupboard	181 lb	23 ft	DG	?	A772	?	\$3,508
56	23-1/2	23-1/2	right	2 file drawers, 29" cupboard	178 lb	23 ft	WG	?	A754	?	\$3,277
			right	2 box/1 file drawer, 29" cupboard	181 lb	23 ft	WG	?	A772	?	\$3,508
65-7/8	23-1/2	23-1/2	left	2 file drawers, 39" cupboard	193 lb	25.7 ft	DG	?	C254	?	\$3,507
			left	2 box/1 file drawer, 39" cupboard	195 lb	25.7 ft	DG	?	C272	?	\$3,627
			left	3 file drawers, 27" cupboard	195 lb	25.7 ft	DG	?	C252	?	\$3,627
			left	2 box/2 file drawers, 27" cupboard	197 lb	25.7 ft	DG	?	C258	?	\$3,747
65-7/8	23-1/2	23-1/2	right	2 file drawers, 39" cupboard	193 lb	25.7 ft	WG	?	C254	?	\$3,507
			right	2 box/1 file drawer, 39" cupboard	195 lb	25.7 ft	WG	?	C272	?	\$3,627
			right	3 file drawers, 27" cupboard	195 lb	25.7 ft	WG	?	C252	?	\$3,627
			right	2 box/2 file drawers, 27" cupboard	197 lb	25.7 ft	WG	?	C258	?	\$3,747

Available Fronts | A D F N Q | S

TRACE TOWERS

SIN 33721

TRACE Mobile Cupboard Wardrobe Tower

- Black 75mm casters: (2) locking and (2) non-locking
- Height listed includes casters (approximately 3")
- 43-1/4" tower: no adjustable shelf
- 54-3/4" tower: one adjustable shelf



H	D	W	Coat Door	Drawer Options	Pkg Wt	Pkg Cube	Part #	Front	Part #	Metal Color	Price
43-1/4	23-1/2	23-1/2	left	file/file	136 lb	18 ft	DG	?	9954	?	\$3,402
			right	file/file	136 lb	18 ft	WG	?	9954	?	\$3,402
54-3/4	23-1/2	23-1/2	left	file/file	170 lb	21 ft	DG	?	J854	?	\$3,706
			right	file/file	170 lb	21 ft	WG	?	J854	?	\$3,706

43-1/4"
Coat Left



54-3/4"
Coat Left



Available Fronts | A B D | F H I N P Q | S

Spec Guide Personal Storage Pedestals Laterals Collab. Islands Lockers Lam Lockers Towers Storage Cabinets Bookcases Cayenne Ht. Adj. Tables Trace Desk Desk Accs Sparkology Terms/Conds

TRACE Cupboard Tower



- Single lock captures cupboard and drawers
- 46" tower: no adjustable shelf
- 51-3/8" tower: one adjustable shelf
- 56" tower: one adjustable shelf
- 65-7/8" tower: two adjustable shelves
- Will not accommodate Work Surface Supporting Bracket

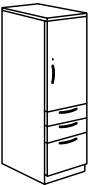

H	D	W	Hinge Location	Drawer Options	Pkg Wt	Pkg Cube	Part #	Front Style	Part #	Metal Color	Price
46	23 -1/2	15 -1/4	left	file/file 19.2" cupboard	81 lb	11 ft	CL	?	N309	?	\$1,950
			right	file/file 19.2" cupboard	81 lb	11 ft	CR	?	N309	?	\$1,950
46	23 -1/2	15 -1/4	left	box/box/file 19.2" cupboard	83 lb	11 ft	CL	?	N311	?	\$2,145
			right	box/box/file 19.2" cupboard	83 lb	11 ft	CR	?	N311	?	\$2,145
51-3/8	23 -1/2	15 -1/4	left	file/file 24.5" cupboard	85 lb	14.2 ft	CL	?	K409	?	\$1,995
			right	file/file 24.5" cupboard	85 lb	14.2 ft	CR	?	K409	?	\$1,995
51-3/8	23 -1/2	15 -1/4	left	box/box/file 24.5" cupboard	87 lb	14.2 ft	CL	?	K411	?	\$2,190
			right	box/box/file 24.5" cupboard	87 lb	14.2 ft	CR	?	K411	?	\$2,190
56	23 -1/2	15 -1/4	left	file/file 29" cupboard	88 lb	15.4 ft	CL	?	N209	?	\$2,043
			right	file/file 29" cupboard	88 lb	15.4 ft	CR	?	N209	?	\$2,043
56	23 -1/2	15 -1/4	left	box/box/file 29" cupboard	91 lb	15.8 ft	CL	?	N211	?	\$2,238
			right	box/box/file 29" cupboard	91 lb	15.8 ft	CR	?	N211	?	\$2,238
65 -7/8	23 -1/2	15 -1/4	left	file/file 39" cupboard	93 lb	17.3 ft	CL	?	K309	?	\$2,100
			right	file/file 39" cupboard	93 lb	17.3 ft	CR	?	K309	?	\$2,100
65 -7/8	23 -1/2	15 -1/4	left	box/box/file 39" cupboard	95 lb	17.3 ft	CL	?	K311	?	\$2,295
			right	box/box/file 39" cupboard	95 lb	17.3 ft	CR	?	K311	?	\$2,295

Available Fronts | A  D | F  N  Q | S

TRACE TOWERS

SIN 33721

TRACE Bookcase Wardrobe Tower



- Tower includes two locks, keyed-alike
- Coat closet includes a two-pronged coat hook
- 46" tower: no adjustable shelf
- 51-3/8" tower: one adjustable shelf
- 56" tower: one adjustable shelf
- 65-7/8" tower: two adjustable shelves
- Work Surface Supporting Bracket may be added

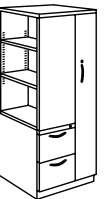
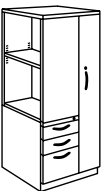
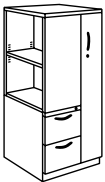
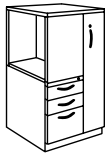

H	D	W	Coat Door	Drawer Options	Pkg Wt	Pkg Cube	Part #	Front	Part #	Metal Color	Price
46	23-1/2	23-1/2	left	file/file	145 lb	18.4 ft	LG	?	V709	?	\$3,348
			left	box/box/file	148 lb	18.4 ft	LG	?	V711	?	\$3,470
46	23-1/2	23-1/2	right	file/file	145 lb	18.4 ft	MG	?	V709	?	\$3,348
			right	box/box/file	148 lb	18.4 ft	MG	?	V711	?	\$3,470
51-3/8	23-1/2	23-1/2	left	file/file	152 lb	21.0 ft	LG	?	J609	?	\$3,456
			left	box/box/file	155 lb	21.0 ft	LG	?	J611	?	\$3,576
51-3/8	23-1/2	23-1/2	right	file/file	152 lb	21.0 ft	MG	?	J609	?	\$3,456
			right	box/box/file	155 lb	21.0 ft	MG	?	J611	?	\$3,576
56	23-1/2	23-1/2	left	file/file	159 lb	23.4 ft	LG	?	V609	?	\$3,566
			left	box/box/file	162 lb	23.4 ft	LG	?	V611	?	\$3,683
56	23-1/2	23-1/2	right	file/file	159 lb	23.4 ft	MG	?	V609	?	\$3,566
			right	box/box/file	162 lb	23.4 ft	MG	?	V611	?	\$3,683
65-7/8	23-1/2	23-1/2	left	file/file	166 lb	25.7 ft	LG	?	C209	?	\$3,757
			left	box/box/file	169 lb	25.7 ft	LG	?	C211	?	\$3,877
65-7/8	23-1/2	23-1/2	right	file/file	166 lb	25.7 ft	MG	?	C209	?	\$3,757
			right	box/box/file	169 lb	25.7 ft	MG	?	C211	?	\$3,877

Available Fronts | A D | F N Q | S

TRACE
Bookcase Tower



- Single lock captures all drawers
- 46" tower: no adjustable shelf
- 51-3/8" tower: one adjustable shelf
- 56" tower: one adjustable shelf
- 65-7/8" tower: two adjustable shelves
- Work Surface Supporting Bracket may be added

H	D	W	Bookcase Facing	Drawer Options	Pkg Wt	Pkg Cube	Part #	Front	Part #	Metal Color	Price
46	23-1/2	15-1/4	left	file/file	82 lb	12.5 ft	BL	?	4609	?	\$1,886
			left	box/box/file	87 lb	12.5 ft	BL	?	4611	?	\$1,935
46	23-1/2	15-1/4	right	file/file	82 lb	12.5 ft	BR	?	4609	?	\$1,886
			right	box/box/file	87 lb	12.5 ft	BR	?	4611	?	\$1,935
51-3/8	23-1/2	15-1/4	left	file/file	85 lb	14.2 ft	BL	?	5109	?	\$1,899
			left	box/box/file	90 lb	14.2 ft	BL	?	5111	?	\$1,959
51-3/8	23-1/2	15-1/4	right	file/file	85 lb	14.2 ft	BR	?	5109	?	\$1,899
			right	box/box/file	90 lb	14.2 ft	BR	?	5111	?	\$1,959
56	23-1/2	15-1/4	left	file/file	87 lb	15.6 ft	BL	?	5609	?	\$1,914
			left	box/box/file	93 lb	15.6 ft	BL	?	5611	?	\$1,981
56	23-1/2	15-1/4	right	file/file	87 lb	15.6 ft	BR	?	5609	?	\$1,914
			right	box/box/file	93 lb	15.6 ft	BR	?	5611	?	\$1,981
65-7/8	23-1/2	15-1/4	left	file/file	90 lb	17.3 ft	BL	?	6509	?	\$1,938
			left	box/box/file	95 lb	17.3 ft	BL	?	6511	?	\$2,022
65-7/8	23-1/2	15-1/4	right	file/file	90 lb	17.3 ft	BR	?	6509	?	\$1,938
			right	box/box/file	95 lb	17.3 ft	BR	?	6511	?	\$2,022

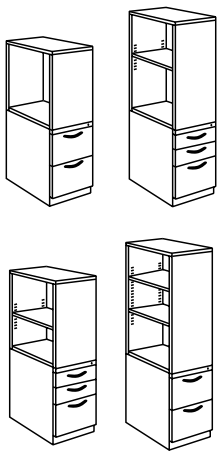

Available Fronts | A D | F N Q | S

Work Surface
Supporting Bracket

- May be added to any Bookcase Wardrobe Tower or Bookcase Tower with side facing bookcase
- May not be used on cupboard tower
- Factory installed only
- Supports 1-1/4" work surface at 27-3/4" finish height
- Black bracket is 17" wide, extends 3"
- Three mounting holes for work surface attachment
- Modesty panel not available for this application

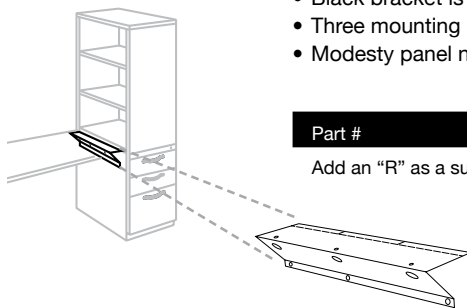

Part #	Price
Add an "R" as a suffix to the Bookcase Wardrobe Tower or Bookcase Tower part number.	\$102



Basic Construction

- All Great Openings products meet or exceed applicable ANSI-BIFMA standards for durability and safety
- Welded steel frame construction and formed channels ensure strength in key areas
- Reinforced vertical and horizontal channels ensure dimensional stability
- Double Door Storage Cabinet metal gauge: Top, back, side and center panels are 21 gauge steel, inner top, bottom, and side channels are 18 gauge steel. Door fronts are 20-22 gauge steel. Shelves are 18 gauge steel
- Concealed hinges allow for 110° opening
- Four leveling glides with 1-1/4" adjustment ensure proper alignment and operation, and are accessible from inside the cabinet
- Shelves are 3/4" thick and are adjustable in 1-1/2" increments
- Inside width dimensions shown in "Inside Dimensions" table are for the door opening. An additional 1.75" in width is available once inside the door hinges
- The front-facing kick plate on Trace double door storage cabinets is 3.25" high

Features

- Top is mechanically fastened, so may be replaced with laminate top

Options and Accessories

- All options and accessories are sold separately or are available as an upgrade
- Additional shelves are available for order
- Magnetic shelf divider, sold in packages of three

Lock System

- Keyed locks include randomly-assigned UM Series locks
- UM locks are black-faced, master-keyed, and core-removable
- Locks may be keyed-alike in the field
- Other key series are available, including Haworth SL, bright nickel LL, and Knoll K. See the Specification Guide for details and how to order
- Double Doors Storage Cabinets are not available with individually locking doors
- Electronic locks are available. Please call Sales for details

Trace Storage Cabinet Inside Dimensions (in inches)

	Inner Height	Inner Width	Inner Depth
(each shelf is .75" tall, so deduct .75" inside height per shelf)			
(gain 1.75" in width, once past the hinges)			
2-high cabinet, 30" wide	23.5"	26.75"	17.3"
2-high cabinet, 36" wide	23.5"	32.75"	17.3"
2-high cabinet, 42" wide	23.5"	38.75"	17.3"
3-high cabinet, 30" wide	35.0"	26.75"	17.3"
3-high cabinet, 36" wide	35.0"	32.75"	17.3"
3-high cabinet, 42" wide	35.0"	38.75"	17.3"
4-high cabinet, 30" wide	46.5"	26.75"	17.3"
4-high cabinet, 36" wide	46.5"	32.75"	17.3"
4-high cabinet, 42" wide	46.5"	38.75"	17.3"
5-high cabinet, 30" wide	61.0"	26.75"	17.3"
5-high cabinet, 36" wide	61.0"	32.75"	17.3"
5-high cabinet, 42" wide	61.0"	38.75"	17.3"
6-high cabinet, 30" wide	72.5"	26.75"	17.3"
6-high cabinet, 36" wide	72.5"	32.75"	17.3"
6-high cabinet, 42" wide	72.5"	38.75"	17.3"

TRACE METAL STORAGE CABINETS

SIN 33721

TRACE Double Door Storage Cabinet

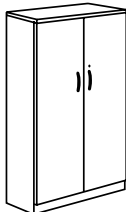
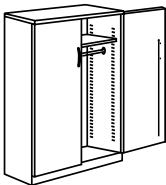
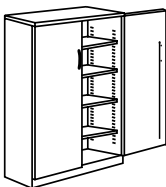
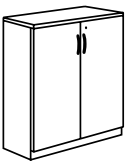
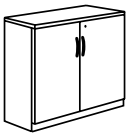
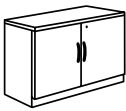

- See descriptions in table below for number of shelves included
- Common laminate tops are available
- Shelf load capacities:
30" shelf - 140 lbs
36" shelf - 140 lbs
42" shelf - 140 lbs
Note: each shelf is 3/4" tall
- Cabinet top weight capacities:
30" cabinet - 140 bs
36" cabinet - 168 lbs
42" cabinet - 197 lbs

H	D	W	Description	Pkg Wt	Pkg Cube	Part #	Door Style	Part #	Metal Color	Price
28-3/8	18-1/4	30		66 lb	12.7 ft	CG	?	01F2	?	\$1,585
28-3/8	18-1/4	36	2-high double door 1 adjustable shelf	78 lb	15.5 ft	CG	?	02F3	?	\$1,725
28-3/8	18-1/4	42		90 lb	17.3 ft	CG	?	03F4	?	\$1,902
39-7/8	18-1/4	30		88 lb	17.4 ft	CG	?	04F2	?	\$1,932
39-7/8	18-1/4	36	3-high double door 2 adjustable shelves	100 lb	20.6 ft	CG	?	05F3	?	\$1,959
39-7/8	18-1/4	42		110 lb	23.7 ft	CG	?	06F4	?	\$2,088
51-3/8	18-1/4	30		113 lb	22.1 ft	CG	?	07F2	?	\$2,157
51-3/8	18-1/4	36	4-high double door 3 adjustable shelves	125 lb	26.1 ft	CG	?	08F3	?	\$2,346
51-3/8	18-1/4	42		137 lb	30.9 ft	CG	?	09F4	?	\$2,513
65-7/8	18-1/4	30		138 lb	28.0 ft	CG	?	10F2	?	\$2,598
65-7/8	18-1/4	36	5-high double door 4 adjustable shelves	150 lb	33.1 ft	CG	?	11F3	?	\$2,733
65-7/8	18-1/4	42		162 lb	38.1 ft	CG	?	12F4	?	\$2,951
65-7/8	18-1/4	36	5h x 36w w/coat rod no shelves	130 lb	33.0 ft	CG	?	11F5	?	\$2,496
65-7/8	18-1/4	36	5h x 36w w/shelf top/coat rod below	130 lb	33.0 ft	CG	?	11F6	?	\$2,598
77-3/8	18-1/4	30		168 lb	32.6 ft	CG	?	45F2	?	\$2,977
77-3/8	18-1/4	36	6-high double door 5 adjustable shelves	180 lb	38.6 ft	CG	?	46F3	?	\$3,112
77-3/8	18-1/4	42		192 lb	44.5 ft	CG	?	47F4	?	\$3,281
77-3/8	18-1/4	36	6h x 36w w/ shelf top/coat rod below	146 lb	38.6 ft	CG	?	46F7	?	\$2,977
			additional 30" shelf	8 lb	1.5 ft			DBS30	?	\$142
			additional 36" shelf	10 lb	1.5 ft			DBS36	?	\$142
			additional 42" shelf	12 lb	1.5 ft			DBS42	?	\$142

Available Fronts | A Q | S

**TRACE Full
Depth Double
Door Cabinet**

- Features are identical to the Trace Double Door Storage Cabinet
- Includes one side-to-side coat rod and single shelf above, or (4) or (5) adjustable shelves



H	D	W	Description	Pkg Wt	Pkg Cube	Part #	Door	Part #	Metal Color	Price
65-7/8	23-1/2	36	5h double door w/ shelf & coat rod	135 lb	38 ft	CG	?	U777	?	\$3,020
65-7/8	23-1/2	36	5h double door 4 adjustable shelves	165 lb	38 ft	CG	?	U7F3	?	\$3,178
77-3/8	23-1/2	36	6h double door w/ shelf & coat rod	155 lb	43 ft	CG	?	V877	?	\$3,315
77-3/8	23-1/2	36	6h double door 5 adjustable shelves	195 lb	43 ft	CG	?	V8F3	?	\$3,488
one additional shelf and clips								COL 036	?	\$151

Available Fronts | A Q | S

Individual Tops for TRACE Double Door Storage Cabinets

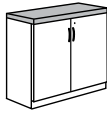

- Laminate top may be factory-installed or shipped separately
- When factory-installed, the list price shown will be added to the accompanying cabinet price
- A metal top is not included when using a laminate top
- The finish height of a storage cabinet file will be 5/8" taller when using a 1-1/4" laminate top than the height of a storage cabinet with metal top
- Specify any standard GO laminate and edge. Special order laminates may require an up-charge and/or extended lead-time; call for details
- Laminate tops used on individual storage cabinets are sized to be flush with the sides of the cabinet case, so that individual cabinets installed side-by-side will have no gaps between

Description	H	W	D	Pkg Wt	Pkg Cube	Part #	Lam/Edge #	Price
factory installed	1.25	30	18.25	n/a	n/a	Add laminate color as a suffix to the lateral part number	?	\$474
	1.25	36	18.25	n/a	n/a	Add this price to lateral price	?	\$533
	1.25	42	18.25	n/a	n/a		?	\$590
top shipped separately	1.25	30	18.25	19 lb	.6 ft	FC 1931	?	\$570
	1.25	36	18.25	23 lb	.7 ft	FC 1937	?	\$638
	1.25	42	18.25	26 lb	1.0 ft	FC 1943	?	\$707

Common Laminate Tops for TRACE Double Door Storage Cabinets

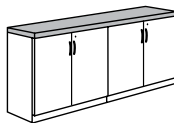

- Common laminate tops are shipped separately, to be installed in the field
- The finish height of a Trace Double Door Cabinet will be 5/8" taller when using a 1-1/4" laminate top than the height of a cabinet with metal top
- Common top sizes allow for 1/8" overhang on all four sides
- It is recommended that you remove the metal top from cabinet before attaching the common laminate top
- Specify any standard GO laminate and edge. Special order laminates may require an up-charge and/or extended lead-time; call for details

Two Cabinets Side-by-Side:	H	W	D	Pkg Wt	Pkg Cube	Part #	Lam/Edge #	Price
(2) 30" DD Storage Cabinet	1.25	60.25	18.50	39 lb	.8 ft	TL 1860	?	\$644
(1) 30" & (1) 36" DD Storage Cabinet	1.25	66.25	18.50	43 lb	.9 ft	TL 1866	?	\$702
(2) 36" DD Storage Cabinet	1.25	72.25	18.50	47 lb	1.0 ft	TL 1872	?	\$759
(2) 42" DD Storage Cabinet	1.25	84.25	18.50	55 lb	1.1 ft	TL 1884	?	\$829

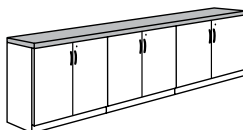

Three Cabinets Side-by-Side:	H	W	D	Pkg Wt	Pkg Cube	Part #	Lam/Edge #	Price
(3) 30" DD Storage Cabinet	1.25	90.25	18.50	58 lb	1.2 ft	TL 1890	?	\$838
(3) 36" DD Storage Cabinet	1.25	108.25	18.50	70 lb	1.4 ft	TL 18108	?	\$1,084
(3) 42" DD Storage Cabinet	1.25	126.25	18.50	82 lb	1.7 ft	TL 18126	?	\$1,358

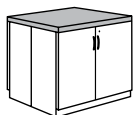

Two Cabinets Back-to-Back:	H	W	D	Pkg Wt	Pkg Cube	Part #	Lam/Edge #	Price
(2) 30" DD Storage Cabinet	1.25	30.25	36.75	39 lb	.8 ft	TL 3730	?	\$676
(2) 36" DD Storage Cabinet	1.25	36.25	36.75	47 lb	1.0 ft	TL 3736	?	\$818
(2) 42" DD Storage Cabinet	1.25	42.25	36.75	54 lb	1.1 ft	TL 3742	?	\$825



Four Cabinets Back-to-Back:	H	W	D	Pkg Wt	Pkg Cube	Part #	Lam/Edge #	Price
(4) 30" DD Storage Cabinet	1.25	60.25	36.75	77 lb	1.6 ft	TL 3760	?	\$1,087
(4) 36" DD Storage Cabinet	1.25	72.25	36.75	93 lb	1.9 ft	TL 3772	?	\$1,342
(4) 42" DD Storage Cabinet	1.25	84.25	36.75	108 lb	2.2 ft	TL 3784	?	\$1,414

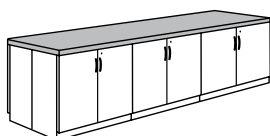

Six Cabinets Back-to-Back:	H	W	D	Pkg Wt	Pkg Cube	Part #	Lam/Edge #	Price
(6) 30" DD Storage Cabinet	1.25	90.25	36.75	116 lb	2.5 ft	TL 3790	?	\$1,576
(6) 36" DD Storage Cabinet	1.25	108.25	36.75	138 lb	2.8 ft	TL 37108	?	\$1,891
(6) 42" DD Storage Cabinet	1.25	126.25	36.75	162 lb	3.5 ft	TL 37126	?	\$2,282

LAMINATE BASE STORAGE CABINETS

Laminate Mobile Cabinets

- Available in 16 laminates (HPL) with matching 3mm edge bands
- Magnetic option is recessed into sides to allow quick pairing
- 4" locking casters
- UM black lock
- Adjustable shelf



H	D	W	Description	Part #	Front	Lam/Edge #	List Price
30	24	30	Mobile Cabinet 2 Doors Magnets On Both Sides	EBBC-302430	?	?	\$2,863
30	24	36	Mobile Cabinet 2 Doors Magnets On Both Sides	EBBC-302436	?	?	\$3,061
30	24	48	Mobile Cabinet 2 Doors Magnets On Both Sides	EBBC-302448	?	?	\$3,373
36	24	30	Mobile Cabinet 2 Doors Magnets On Both Sides	EBBC-362430	?	?	\$3,061
36	24	36	Mobile Cabinet 2 Doors Magnets On Both Sides	EBBC-362436	?	?	\$3,260
36	24	48	Mobile Cabinet 2 Doors Magnets On Both Sides	EBBC-362448	?	?	\$3,571
30	24	30	Mobile Cabinet 2 Doors No Magnets	EBNC-302430	?	?	\$2,779
30	24	36	Mobile Cabinet 2 Doors No Magnets	EBNC-302436	?	?	\$2,976
30	24	48	Mobile Cabinet 2 Doors No Magnets	EBNC-302448	?	?	\$3,260
36	24	30	Mobile Cabinet 2 Doors No Magnets	EBNC-362430	?	?	\$2,976
36	24	36	Mobile Cabinet 2 Doors No Magnets	EBNC-362436	?	?	\$3,146
36	24	48	Mobile Cabinet 2 Doors No Magnets	EBNC-362448	?	?	\$3,430

Laminate Base Cabinets

- Available in 16 laminates (HPL) with matching 3mm edge bands
- UM black lock
- Adjustable shelf



H	D	W	Description	Part #	Front	Lam/Edge #	List Price
30	24	30	Base Cabinet, 2 Doors, No Magnets	EBNN-302430	?	?	\$2,063
30	24	36	Base Cabinet, 2 Doors, No Magnets	EBNN-302436	?	?	\$2,200
30	24	48	Base Cabinet, 2 Doors, No Magnets	EBNN-302448	?	?	\$2,449
36	24	30	Base Cabinet, 2 Doors, No Magnets	EBNN-362430	?	?	\$2,234
36	24	36	Base Cabinet, 2 Doors, No Magnets	EBNN-362436	?	?	\$2,347
36	24	48	Base Cabinet, 2 Doors, No Magnets	EBNN-362448	?	?	\$2,608



Basic Construction

- All Great Openings products meet or exceed applicable ANSI-BIFMA standards for durability and safety
- Welded steel frame construction and formed channels ensure strength in key areas
- Double wall construction on side panels
- Bottom channels, top and shelves are all 18 gauge
- Back panel, side channels and side panels are 22 gauge.
- Shelves are 1" tall and are adjustable in 1/2" increments
- Four leveling glides with 5/8" adjustment ensure proper alignment and operation
- Actual outside widths of bookcases are:
 - 30" = 29-11/16"
 - 36" = 35-11/16"
 - 42" = 41-11/16"
- Outer side panels are flush with the sides of bookcase top, so there's no gap between bookcases when installed side-by-side
- To ensure stability, 4, 5, and 6-high bookcases should be installed against a wall or other solid object
- Shelf capacity, all widths: 140 lbs

Features

- 2-high bookcases will accommodate binder-height storage on both shelves. For all other bookcases, binder-height storage is available on all but one shelf
- Top is mechanically fastened, so may be replaced with a laminate top

Options and Accessories

- All options and accessories are sold separately or are available as an upgrade
- Additional shelves are available for order
- Magnetic shelf divider, sold in packages of three

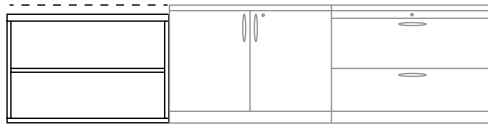

Note that the 2-high bookcase is slightly shorter than the 2-high lateral file and double door storage cabinet. The bookcase is designed to fit under a work surface.

Trace Bookcase Inside Dimensions (in inches)

	Inner Height	Inner Width	Inner Depth
(Each shelf is 1" thick, so deduct 1" inside height per shelf)			
2-high bookcase, 30" wide	25.19"	27.69"	13.06"
2-high bookcase, 36" wide	25.19"	33.69"	13.06"
2-high bookcase, 42" wide	25.19"	39.42"	13.06"
3-high bookcase, 30" wide	37.31"	27.69"	13.06"
3-high bookcase, 36" wide	37.31"	33.69"	13.06"
3-high bookcase, 42" wide	37.31"	39.42"	13.06"
4-high bookcase, 30" wide	48.81"	27.69"	13.06"
4-high bookcase, 36" wide	48.81"	33.69"	13.06"
4-high bookcase, 42" wide	48.81"	39.42"	13.06"
5-high bookcase, 30" wide	63.31"	27.69"	13.06"
5-high bookcase, 36" wide	63.31"	33.69"	13.06"
5-high bookcase, 42" wide	63.31"	39.42"	13.06"
6-high bookcase, 30" wide	74.81"	27.69"	13.06"
6-high bookcase, 36" wide	74.81"	33.69"	13.06"
6-high bookcase, 42" wide	74.81"	39.42"	13.06"

TRACE Bookcase



H	D	W	Shelf Options	Pkg Wt	Pkg Cube	Part #	Metal Color	Price
27-3/4	13-7/16	30	2-high bookcase 1 adjustable shelf	55 lb	10.0 ft	GBS 3028	?	\$1,088
27-3/4	13-7/16	36		67 lb	11.3 ft	GBS 3628	?	\$1,142
27-3/4	13-7/16	42		79 lb	13.0 ft	GBS 4228	?	\$1,199
39-7/8	13-7/16	30	3-high bookcase 2 adjustable shelves	70 lb	13.6 ft	GBS 3040	?	\$1,242
39-7/8	13-7/16	36		82 lb	16.1 ft	GBS 3640	?	\$1,271
39-7/8	13-7/16	42		94 lb	18.6 ft	GBS 4240	?	\$1,323
51-3/8	13-7/16	30	4-high bookcase 3 adjustable shelves	85 lb	14.2 ft	GBS 3052	?	\$1,361
51-3/8	13-7/16	36		90 lb	17.2 ft	GBS 3652	?	\$1,414
51-3/8	13-7/16	42		114 lb	23.7 ft	GBS 4252	?	\$1,470
65-7/8	13-7/16	30	5-high bookcase 4 adjustable shelves	106 lb	21.3 ft	GBS 3066	?	\$1,505
65-7/8	13-7/16	36		118 lb	25.3 ft	GBS 3666	?	\$1,569
65-7/8	13-7/16	42		130 lb	29.2 ft	GBS 4266	?	\$1,623
77-3/8	13-7/16	30	6-high bookcase 5 adjustable shelves	122 lb	25.4 ft	GBS 3077	?	\$1,634
77-3/8	13-7/16	36		134 lb	30.1 ft	GBS 3677	?	\$1,686
77-3/8	13-7/16	42		146 lb	34.7 ft	GBS 4277	?	\$1,751
			additional 30" shelf	6 lb	1.5 ft	BK 0700S	?	\$128
additional shelves			additional 36" shelf	7 lb	1.5 ft	BK 0800S	?	\$128
			additional 42" shelf	8 lb	1.5 ft	BK 0900S	?	\$128

**TRACE Bookcase
Laminate Top**

- Factory installed 1-1/4" laminate top replaces the standard metal top
- Finish height of bookcase will be 5/8" taller than the height of a standard bookcase with metal top
- Laminate top will overhang the metal bookcase sides by 1/8", and it will be flush at front and back
- Specify the laminate and edge band as a suffix to the bookcase part number
- Add the price shown to the list price of the bookcase

W	D	Description	Pkg Wt	Pkg Cube	Part #	Lam/Edge #	Price
29.94	13.4375	factory installed	15 lb	.28 ft	Add laminate color as a suffix to the bookcase part number	?	\$447
35.94	13.4375	factory installed	17 lb	.30 ft		?	\$476
41.94	13.4375	factory installed	19 lb	.40 ft		?	\$538

Mobile Bookcase



- Black 37mm plastic casters
- Casters: 2 locking, 2 non-locking
- Satin nickel loop pull on each side
- Bookcase itself is 30" wide
- With loop pulls, total width is 32-1/2"
- Inside clear height: 24" with 1/2" shelf
- Inside clear depth: 15", width: 27-7/8"
- Shelf is adjustable in 1/2" increments
- As with all GO bookcases, the mobile bookcase does include a back panel

H	D	W	Description	Pkg Wt	Pkg Cube	Part #	Metal Color	Price
26-1/2	15-1/4	32-1/2	1 adjustable shelf	57 lb	10.5 ft	MBC 2000	?	\$1,355

**Magnetic Shelf
Divider**

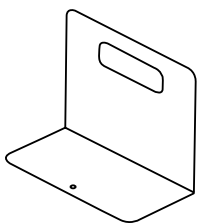

- Black magnetic dividers are 7.5" tall and 8" wide, with a 4" base. Magnet is 7-7/8" x 3"
- Appropriate for use on any lateral file drawer or shelf, bookcase, double door storage cabinet or overhead storage cabinet

H	D	W	Description	Pkg Wt	Pkg Cube	Part #	Price
7-1/2	4	8	(package of 3)	2 lb	2 ft	LFM 300 30	\$76

LAMINATE STACK SHELVING

Laminate Stack Shelving

- Available in 16 laminates (HPL) with matching 3mm edge bands
- Combinations begin with a starter, and continue using adders and finishes with an ender
- Adjustable shelves
- To ensure stability, freestanding shelving should be installed against a wall or other solid object

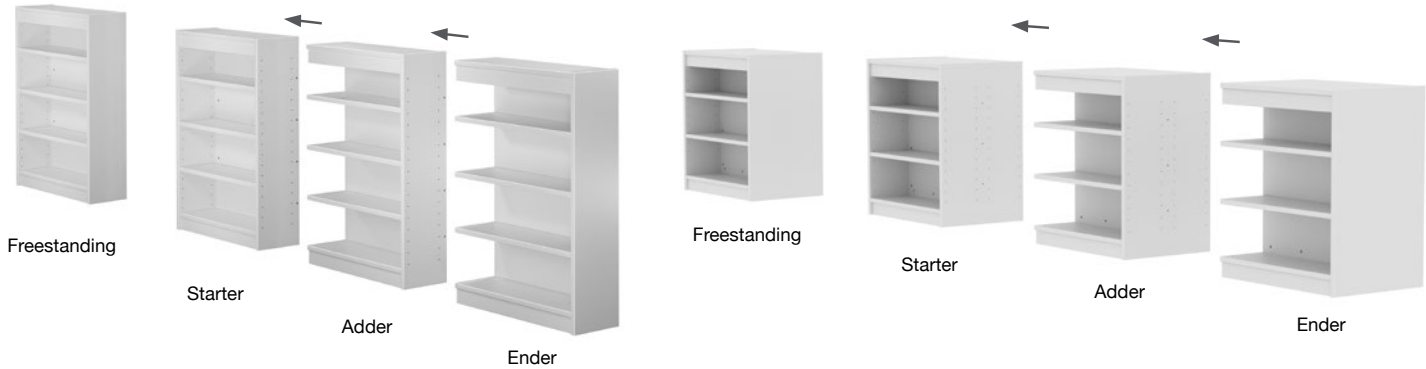

H	D	W	Description	Part #	Lam/ Edge #	Price
29	12	36	Single sided HPL freestanding shelving, 1 fixed, 1 adj. lam. shelf	EFSS-291236	?	\$1,548
40	12	36	Single sided HPL freestanding shelving, 1 fixed, 2 adj. lam. shelves	EFSS-401236	?	\$2,083
51	12	36	Single sided HPL freestanding shelving, 1 fixed, 3 adj. lam. shelves	EFSS-511236	?	\$2,611
66	12	36	Single sided HPL freestanding shelving, 1 fixed, 4 adj. lam. shelves	EFSS-661236	?	\$3,079
77	12	36	Single sided HPL freestanding shelving, 1 fixed, 5 adj. lam. shelves	EFSS-771236	?	\$3,426
29	24	36	Double sided HPL freestanding shelving, 1 fixed, 1 adj. lam. shelf per face	EFSD-292436	?	\$2,550
40	24	36	Double sided HPL freestanding shelving, 1 fixed, 2 adj. lam. shelves per face	EFSD-402436	?	\$3,266
51	24	36	Double sided HPL freestanding shelving, 1 fixed, 3 adj. lam. shelves per face	EFSD-512436	?	\$4,303
66	24	36	Double sided HPL freestanding shelving, 1 fixed, 4 adj. lam. shelves per face	EFSD-662436	?	\$4,627
77	24	36	Double sided HPL freestanding shelving, 1 fixed, 5 adj. lam. shelves per face	EFSD-772436	?	\$4,705
29	12	36	Single sided HPL starter shelving, 1 fixed, 1 adj. lam. shelf	ESSS-291236	?	\$1,559
40	12	36	Single sided HPL starter shelving, 1 fixed, 2 adj. lam. shelves	ESSS-401236	?	\$2,094
51	12	36	Single sided HPL starter shelving, 1 fixed, 3 adj. lam. shelves	ESSS-511236	?	\$2,622
66	12	36	Single sided HPL starter shelving, 1 fixed, 4 adj. lam. shelves	ESSS-661236	?	\$3,091
77	12	36	Single sided HPL starter shelving, 1 fixed, 5 adj. lam. shelves	ESSS-771236	?	\$3,437
29	24	36	Double sided HPL starter shelving, 1 fixed, 1 adj. lam. shelf per face	ESSD-292436	?	\$2,561
40	24	36	Double sided HPL starter shelving, 1 fixed, 2 adj. lam. shelves per face	ESSD-402436	?	\$3,277
51	24	36	Double sided HPL starter shelving, 1 fixed, 3 adj. lam. shelves per face	ESSD-512436	?	\$4,314
66	24	36	Double sided HPL starter shelving, 1 fixed, 4 adj. lam. shelves per face	ESSD-662436	?	\$4,638
77	24	36	Double sided HPL starter shelving, 1 fixed, 5 adj. lam. shelves per face	ESSD-772436	?	\$4,716
29	12	36	Single sided HPL Adder shelving, 1 fixed, 1 adj. lam. shelf	EASS-291236	?	\$1,526
40	12	36	Single sided HPL Adder shelving, 1 fixed, 2 adj. lam. shelves	EASS-401236	?	\$1,851
51	12	36	Single sided HPL Adder shelving, 1 fixed, 3 adj. lam. shelves	EASS-511236	?	\$2,077
66	12	36	Single sided HPL Adder shelving, 1 fixed, 4 adj. lam. shelves	EASS-661236	?	\$2,743
77	12	36	Single sided HPL Adder shelving, 1 fixed, 5 adj. lam. shelves	EASS-771236	?	\$3,184
29	24	36	Double sided HPL Adder shelving, 1 fixed, 1 adj. lam. shelf per face	EASD-292436	?	\$2,220
40	24	36	Double sided HPL Adder shelving, 1 fixed, 2 adj. lam. shelves per face	EASD-402436	?	\$2,831
51	24	36	Double sided HPL Adder shelving, 1 fixed, 3 adj. lam. shelves per face	EASD-512436	?	\$3,261
66	24	36	Double sided HPL Adder shelving, 1 fixed, 4 adj. lam. shelves per face	EASD-662436	?	\$4,153
77	24	36	Double sided HPL Adder shelving, 1 fixed, 5 adj. lam. shelves per face	EASD-772436	?	\$4,231
29	12	36	Single sided HPL Ender shelving, 1 fixed, 1 adj. lam. shelf	EESS-291236	?	\$1,509
40	12	36	Single sided HPL Ender shelving, 1 fixed, 2 adj. lam. shelves	EESS-401236	?	\$1,888
51	12	36	Single sided HPL Ender shelving, 1 fixed, 3 adj. lam. shelves	EESS-511236	?	\$2,120
66	12	36	Single sided HPL Ender shelving, 1 fixed, 4 adj. lam. shelves	EESS-661236	?	\$2,807
77	12	36	Single sided HPL Ender shelving, 1 fixed, 5 adj. lam. shelves	EESS-771236	?	\$3,254
29	24	36	Double sided HPL Ender shelving, 1 fixed, 1 adj. lam. shelf	EESD-292436	?	\$2,262
40	24	36	Double sided HPL Ender shelving, 1 fixed, 2 adj. lam. shelves per face	EESD-402436	?	\$3,078
51	24	36	Double sided HPL Ender shelving, 1 fixed, 3 adj. lam. shelves per face	EESD-512436	?	\$3,334
66	24	36	Double sided HPL Ender shelving, 1 fixed, 4 adj. lam. shelves per face	EESD-662436	?	\$4,241
77	24	36	Double sided HPL Ender shelving, 1 fixed, 5 adj. lam. shelves per face	EESD-772436	?	\$4,320

Basic Construction

- Cayenne storage cabinets feature 3" high architectural legs, available in two styles
- The Cayenne cabinet and drawer front heights do not match those of Trace storage
- All Great Openings products meet or exceed applicable ANSI-BIFMA standards for durability and safety
- Welded steel frame construction and formed channels ensure strength in key areas
- Reinforced vertical and horizontal channels ensure dimensional stability
- Top and side channels are 20 gauge cold rolled steel. Fronts, tops, outer panels are 20 and 22 gauge. Drawer bins and shelves are 18 and 20 gauge
- Metal and laminate tops are 5/8" thick
- Four leveling glides with 1/2" adjustment ensure proper alignment and operation

Features

- Cayenne cabinet legs are painted 02R1 Nickel; any Great Openings cabinet or desk products may be painted that same color with no extra charge
- All drawers and roll-out shelves include full extension steel ball-bearing slides with anti-rebound features to ensure smooth operation
- Cayenne storage metal and laminate tops are sized to be flush with the sides of the cabinet, so that files installed side-to-side will have no gaps between
- Drawers include full-height side panels
- Two file bars are included in each drawer, for side-to-side filing. File conversion bars for front-to-back filing are sold separately
- Drawer bins will accommodate A4, Letter, and Legal size filing

Options and Accessories

- Cayenne storage may be ordered with metal top, laminate top, or no top. The no top option should be used when ganging two cabinets side-by-side with a common laminate top
- Cushions with non-slip backing are available in five sizes
- All options and accessories are sold separately or are available as an upgrade
- Laminate drawer fronts may be specified. See the Specification Guide for details
- Common laminate tops
- Individually locking drawers, either keyed or electronic
- File conversion bars for front-to-back filing
- Magnetic drawer dividers for Cayenne box drawers

Lock System

- All Great Openings products include randomly-assigned UM Series locks
- UM locks are black-faced, master-keyed, and core-removable
- Locks may be keyed-alike in the field
- Other key series are available, including Haworth SL, bright nickel LL, and Knoll K. See the Specification Guide for details and how to order
- The Cayenne lock system captures just the right hand side of drawer fronts
- Cayenne storage may not be ordered to include individually locking security drawers

Counterweights & Interlock

- The safety interlock mechanism is integrated into the drawer slides, allowing only one drawer to open at a time
- Counterweight is included as standard in Two Drawer cabinets and Rollout Shelf cabinets

Drawer Load Capacity

Drawers and rollout shelf load capacity:
 -30", 36", and 42" wide drawers: 125 lb
 Fixed and adjustable shelf load capacity:
 - 30" drawers: 95 lbs
 - 36" drawers: 116 lbs
 - 42" drawers: 136 lbs
 Cayenne storage metal top load capacity:
 - 30" drawers: 140 lbs
 - 36" drawers: 168 lbs
 - 42" drawers: 192 lbs



S: Round



R: Rectangle

Storage Inside Dimensions (in inches)

	Inner Height	Inner Width	Inner Depth
File Drawers (the bin sides themselves are 9.18" high)			
30" wide	10.86"	26.7"	16.00"
36" wide	10.86"	32.7"	16.00"
42" wide	10.86"	38.7"	16.00"
Box Drawers (the bin sides themselves are 4.24" high)			
30" wide	4.54"	26.7"	16.00"
36" wide	4.54"	32.7"	16.00"
42" wide	4.54"	38.7"	16.00"
Open Shelf (height does not include .75" adjustable shelf)			
30" wide	16.39"	28.55"	19.0"
36" wide	16.39"	34.55"	19.0"
42" wide	16.39"	40.55"	19.0"
Rollout Shelf (height does not include .75" adjustable shelf)			
30" wide	16.04"	26.73"	15.5"
36" wide	16.04"	32.73"	15.5"
42" wide	16.04"	38.73"	15.5"

CAYENNE

SIN 33721

Low Storage, Two Drawer



- Includes one box drawer and one file drawer, both with full extension slides
- Includes safety interlock, allowing just one drawer to open at a time
- Choose from two leg options, all 3" high
- Includes counterweight
- When ganging two cabinets together, order no-top units and a common laminate top with ganging kit

H	D	W	Top	Pkg Wt	Pkg Cube	Part #	Front	Part #	Leg Style	Metal Color	Lam/Edge #	Price
22-1/4	20	30	metal	125 lb	8.3 ft	M-LRU	?	R3L7	?	?	n/a	\$1,697
22-1/4	20	36	metal	145 lb	9.8 ft	M-LRU	?	R4L7	?	?	n/a	\$1,804
22-1/4	20	42	metal	165 lb	11.3 ft	M-LRU	?	U8L7	?	?	n/a	\$1,918
22-1/4	20	30	lam.	126 lb	8.3 ft	M-LRU	?	R3L7	?	?	?	\$2,197
22-1/4	20	36	lam.	146 lb	9.8 ft	M-LRU	?	R4L7	?	?	?	\$2,336
22-1/4	20	42	lam.	166 lb	11.3 ft	M-LRU	?	U8L7	?	?	?	\$2,571
21-5/8	20	30	none	118 lb	8.3 ft	M-LRU	?	R3L7	?	?	NT	\$1,623
21-5/8	20	36	none	137 lb	9.8 ft	M-LRU	?	R4L7	?	?	NT	\$1,725
21-5/8	20	42	none	155 lb	11.3 ft	M-LRU	?	U8L7	?	?	NT	\$1,898

Available Fronts | A B D F H J K L P Q | S

Available Legs S: Round, R: Rectangle

Mobile Low Storage, Two Drawer



- Metal or laminate top
- Includes one box drawer and one file drawer, both with full extension slides
- Includes safety interlock, allowing just one drawer to open at a time
- Includes counterweight
- Includes black 75mm casters, two locking and two non-locking

H	D	W	Top	Pkg Wt	Pkg Cube	Part #	Front	Part #	Leg Style	Metal Color	Lam/Edge #	Price
22-7/8	20	30	metal	125 lb	8.3 ft	M-LRU	?	R3L7	M	?	n/a	\$1,697
22-7/8	20	36	metal	145 lb	8.3 ft	M-LRU	?	R4L7	M	?	n/a	\$1,804
22-7/8	20	42	metal	165 lb	8.3 ft	M-LRU	?	U8L7	M	?	n/a	\$1,984
22-7/8	20	30	lam.	126 lb	8.3 ft	M-LRU	?	R3L7	M	?	?	\$2,197
22-7/8	20	36	lam.	146 lb	8.3 ft	M-LRU	?	R4L7	M	?	?	\$2,336
22-7/8	20	42	lam.	166 lb	8.3 ft	M-LRU	?	U8L7	M	?	?	\$2,571

Available Fronts | A B D F H J K L P Q | S

Low Storage,
Open Shelves



- Includes one adjustable shelf
- This unit does not include a false back
- Choose from two leg options, all 3" high
- No counterweight is needed
- When ganging two cabinets together, order no-top units and also a common laminate top with ganging kit

H	D	W	Top	Pkg Wt	Pkg Cube	Part #	Leg Style	Metal Color	Lam/Edge #	Price
22-1/4	20	18	metal	49 lb	5.4 ft	M-LROS Z5P5	?	?	n/a	\$1,318
22-1/4	20	30	metal	63 lb	8.3 ft	M-LROS R3L8	?	?	n/a	\$1,377
22-1/4	20	36	metal	70 lb	9.8 ft	M-LROS R4L8	?	?	n/a	\$1,438
22-1/4	20	42	metal	77 lb	11.3 ft	M-LROS U8L8	?	?	n/a	\$1,612
22-1/4	20	18	lam.	51 lb	5.4 ft	M-LROS Z5P5	?	?	?	\$1,798
22-1/4	20	30	lam.	64 lb	8.3 ft	M-LROS R3L8	?	?	?	\$1,875
22-1/4	20	36	lam.	71 lb	9.8 ft	M-LROS R4L8	?	?	?	\$1,996
22-1/4	20	42	lam.	78 lb	11.3 ft	M-LROS U8L8	?	?	?	\$2,200
21-5/8	20	18	none	46 lb	5.4 ft	M-LROS Z5P5	?	?	NT	\$1,248
21-5/8	20	30	none	57 lb	8.3 ft	M-LROS R3L8	?	?	NT	\$1,302
21-5/8	20	36	none	63 lb	9.8 ft	M-LROS R4L8	?	?	NT	\$1,388
21-5/8	20	42	none	68 lb	11.3 ft	M-LROS U8L8	?	?	NT	\$1,526

Available Legs S: Round, R: Rectangle

Low Storage,
Rollout Shelf

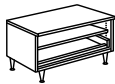

- Includes one adjustable shelf
- Binder height storage is available on the bottom rollout shelf
- Choose from two leg options, all 3" high
- Includes counterweight
- When ganging two cabinets together, order no-top units and also a common laminate top with ganging kit

H	D	W	Top	Pkg Wt	Pkg Cube	Part #	Leg Style	Metal Color	Lam/Edge #	Price
22-1/4	20	30	metal	116 lb	8.3 ft	M-LRT R3M5	?	?	n/a	\$1,641
22-1/4	20	36	metal	123 lb	9.8 ft	M-LRT R4M5	?	?	n/a	\$1,747
22-1/4	20	42	metal	130 lb	11.3 ft	M-LRT U8M5	?	?	n/a	\$1,858
22-1/4	20	30	lam.	117 lb	8.3 ft	M-LRT R3M5	?	?	?	\$2,141
22-1/4	20	36	lam.	124 lb	9.8 ft	M-LRT R4M5	?	?	?	\$2,276
22-1/4	20	42	lam.	131 lb	11.3 ft	M-LRT U8M5	?	?	?	\$2,503
21-5/8	20	30	none	109 lb	8.3 ft	M-LRT R3M5	?	?	NT	\$1,566
21-5/8	20	36	none	115 lb	9.8 ft	M-LRT R4M5	?	?	NT	\$1,667
21-5/8	20	42	none	120 lb	11.3 ft	M-LRT U8M5	?	?	NT	\$1,833

Available Legs S: Round, R: Rectangle

Credenza



- Selected storage cabinets are pre-configured into credenzas so you may order them using a single part number
- Each credenza includes:
 - 2 low storage cabinets
 - 1 common laminate top with ganging kit
 - 1 credenza center leg support (total of 5 legs)
- Credenzas must be assembled in the field
- Cabinets are unhandled so may be configured on left or right side or facing opposite directions

H	D	W	Top	Pkg Wt	Pkg Cube	Part #	Front	Part #	Leg Style	Metal Color	Lam/Edge #	Price
22-1/4	20	48	(1) 30" two drawer & (1) 18" open shelf	175 lb	13.6 ft	LRU	?	Z1N9	?	?	?	\$3,447
22-1/4	20	54	(1) 36" two drawer & (1) 18" open shelf	190 lb	15.1 ft	LRU	?	Z201	?	?	?	\$3,559
22-1/4	20	60	(1) 30" two drawer & (1) 30" open shelf	195 lb	16.6 ft	LRU	?	S705	?	?	?	\$3,600
22-1/4	20	60	(1) 42" two drawer & (1) 18" open shelf	215 lb	16.6 ft	LRU	?	S702	?	?	?	\$3,819
22-1/4	20	66	(1) 36" two drawer & (1) 30" two drawer	272 lb	18.1 ft	LRU	?	Z303	?	?	?	\$4,030
22-1/4	20	66	(1) 30" two drawer & (1) 36" open shelf	197 lb	18.1 ft	LRU	?	Z306	?	?	?	\$3,690
22-1/4	20	66	(1) 36" two drawer & (1) 30" open shelf	210 lb	18.1 ft	LRU	?	Z307	?	?	?	\$3,710
22-1/4	20	72	(1) 36" two drawer & (1) 36" two drawer	292 lb	19.6 ft	LRU	?	S808	?	?	?	\$4,244
22-1/4	20	72	(1) 36" two drawer & (1) 36" open shelf	217 lb	19.6 ft	LRU	?	S809	?	?	?	\$3,902
22-1/4	20	72	(1) 42" two drawer & (1) 30" two drawer	292 lb	19.6 ft	LRU	?	S8P1	?	?	?	\$4,311
22-1/4	20	72	(1) 30" two drawer & (1) 42" open shelf	204 lb	19.6 ft	LRU	?	S8P2	?	?	?	\$3,937
22-1/4	20	72	(1) 42" two drawer & (1) 30" open shelf	230 lb	19.6 ft	LRU	?	S8P3	?	?	?	\$3,991

Available Legs S: Round, R: Rectangle

Available Fronts | A Q | S

Common Tops with Ganging Kit

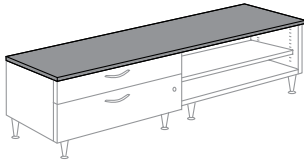

- Create your own credenza by ordering any two Cayenne Low Storage cabinets with the appropriate common top
- Laminate top is 5/8" thick and includes pre-drilled holes for easy assembly
- Order two no-top Cayenne cabinets to be assembled with common top in the field
- Includes ganging kit for bolting two Low Storage Cabinets together

D	W	Lam. Tops for 2 Cabinets	Pkg Wt	Pkg Cube	Part #	Laminate/Edge #	Price
20	30	(1) 18" stack-on (1) 12" tower	21 lb	.43 ft	CYN 2030K	?	\$473
18	40	(2) 18" stack-ons back-to-back	35 lb	.58 ft	CYN4018K	?	\$517
20	36	(2) 18" cabinets or stack-ons	25 lb	.52 ft	CYN 2036K	?	\$496
20	48	(1) 30" (1) 18" cabinets	34 lb	.69 ft	CYN 2048K	?	\$536
20	54	(1) 36" (1) 18" cabinets	38 lb	.78 ft	CYN 2054K	?	\$606
20	60	(1) 42" (1) 18" cabinets	42 lb	.87 ft	CYN 2060K	?	\$615
20	60	(2) 30" cabinets	22 lb	.7 ft	CYN 2060K	?	\$615
20	66	(1) 30" (1) 36" cabinets	24 lb	.8 ft	CYN 2066K	?	\$621
20	72	(2) 36" cabinets	26 lb	.9 ft	CYN 2072K	?	\$715
20	72	(1) 30" & (1) 42" cabinets	26 lb	.9 ft	CYN 2072K	?	\$715
20	78	(1) 36" & (1) 42" cabinets	28 lb	1.0 ft	CYN 2078K	?	\$751
20	84	(2) 42" cabinets	30 lb	1.0 ft	CYN 2084K	?	\$788

Credenza Center Leg Support

- Create your own credenza by ordering any two Cayenne Low Storage cabinets and then using this Credenza Center Leg Support to:
 - Gang the two cabinets tightly together, side-by-side
 - Eliminate the four legs in the center and replace them with this single support leg
- Must be used in conjunction with a common laminate top (shown above)
- Support leg sits in the center, front-to-back, so it's not visible to users
- Support leg is always round, regardless of the cabinet leg style
- Kit includes splice plate, round center leg, fasteners and instructions

Description	Pkg Wt	Pkg Cube	Part #	Price
one splice plate with center leg	2.5 lb	.16 ft	CYPX 0050K	\$111

Cayenne Ganging Kit

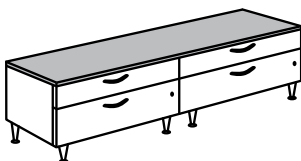

- When sourcing your own Cayenne Low Storage laminate top, use this kit to gang the cabinets together
- Ganging kit includes splice plate, fasteners, and instructions
- Does not include center leg support

Description	Pkg Wt	Pkg Cube	Part #	Price
kit to gang Cayenne cabinets together	1 lb	.2 ft	CSP 01K	\$69

Cushion

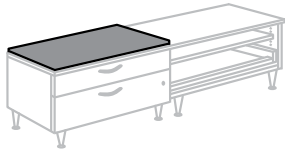

- Foam cushion is 1" thick
- Includes rubber anti-skid material on bottom
- For use on any laminate top cabinet
- Order any standard GO fabric, or COM
- Unless otherwise specified, the fabric grain on all cushions will be applied "front-to-back"

H	D	W	Pkg Wt	Pkg Cube	Part #	Fabric #	GR 1 Price	GR 2 Price	GR 3 Price	GR 4 Price	GR 5 Price	COM Price
1	20	12	4 lb	1.2 ft	NSLP 2012	?	\$237	\$350	\$394	\$439	\$476	\$232
1	20	18	4 lb	1.3 ft	NSLP 2018	?	\$283	\$396	\$439	\$484	\$521	\$278
1	20	30	5 lb	1.5 ft	NSLP 2030	?	\$417	\$576	\$641	\$705	\$757	\$412
1	20	36	6 lb	1.5 ft	NSLP 2036	?	\$474	\$683	\$763	\$848	\$915	\$469
1	20	42	6 lb	1.6 ft	NSLP 2042	?	\$540	\$747	\$830	\$914	\$981	\$535

Magnetic Drawer Dividers - Box Drawer

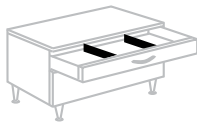

- Dividers fit inside box lateral drawer bins to create sectioned drawer space
- 16" depth divider fits front-to-back in drawer bin, painted black
- Magnets attach to front and back of drawer bin

Description	Pkg Wt	Pkg Cube	Part #	Price
pkg of (4) 16" x 4" dividers	22 lb	1.8 ft	LFM 40042K	\$133

Drawer Front Filler - Cayenne

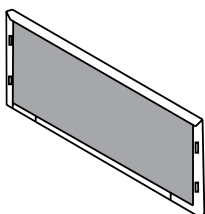

- Cayenne drawers may be upgraded to include a closed cell polyethylene filler piece that adheres to the inside of the drawer front for improved sound dampening
- Drawer Front Filler upgrades, priced per drawer, will be added to the product list price

Description	Pkg Wt	Pkg Cube	Part #	Price Per Drawer
price per drawer	2 lb	.8 ft	Add a "U" as a suffix to the part number	\$92

Available Fronts | A  Q | S

HEIGHT ADJUSTABLE TABLE SPECIFICATIONS

SIN 33721

Basic Construction

- Programmable height handset
- Single stage electric motor
- 29" Cord
- Speed: 1-1/2" per second, power consumption: 0.3W
- The base height adjusts from 29" to 47.5"
- Weight capacity: 265 lbs (does not include work surface)
- 1-1/4" thick laminate top
- Corner desks with laminate top are handed. Please specify left or right

Options and Accessories

- Marty hanging storage
- Metal, acrylic, and tackable privacy screens/modesty panels may be attached to laminate work surfaces

Colors

- Height Adjustable Table bases are available in three colors:
 - 02A4 – White
 - 03Y8 – Black
 - 05F0 – Silver



HEIGHT ADJUSTABLE TABLES

SIN 33721

Rectangular Table Base with Laminate Top

Table bases are available in three colors:

- 02A4 – White
- 03Y8 – Black
- 05F0 – Silver



H	D	W	Lbs.	Part #	Base Color #	Laminate Edge #	Price
29" to 47-1/2"	24"	48"	112	HAT2448	?	?	\$2,450
29" to 47-1/2"	24"	54"	117	HAT2454	?	?	\$2,617
29" to 47-1/2"	24"	60"	122	HAT2460	?	?	\$2,782
29" to 47-1/2"	24"	72"	133	HAT2472	?	?	\$3,103
29" to 47-1/2"	30"	48"	122	HAT3048	?	?	\$2,463
29" to 47-1/2"	30"	54"	129	HAT3054	?	?	\$2,631
29" to 47-1/2"	30"	60"	135	HAT3060	?	?	\$2,796
29" to 47-1/2"	30"	72"	148	HAT3072	?	?	\$3,117

Corner Table Base with Laminate Top

H	D	W	Lbs.	Part #	L or R	Base Color #	Laminate Edge #	Price
27-1/4" to 46-1/4"	24"	48"/60"	170	HAT24486024	?	?	?	\$4,442
27-1/4" to 46-1/4"	30"	48"/60"	185	HAT30486030	?	?	?	\$4,529

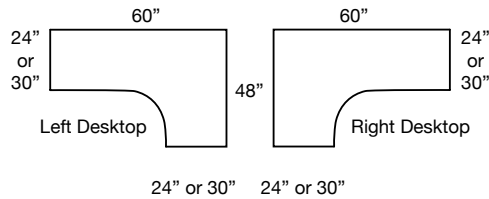

The Trace Freestanding Desk is a modular system of desk shells, returns, bridges, corner units, tables, and individual components that can be mixed and matched with a comprehensive selection of Great Openings storage. All components are shipped knocked down.

Our mission in designing the Freestanding Desk

- Ease of specification. All work surfaces rest primarily on panel and corner legs, rather than pedestals. Storage options are innumerable, and simply slide beneath the desk shells, return shells, and corner desks for quick installation
- Ease of assembly. All metal attachment points are pre-drilled, so that no “drill point” screws are required during installation. All modesty panels attach to panel legs and corner legs, rather than to pedestals
- Ease-of-work surface installation. Pre-drilled work surfaces make it easy to position legs, pedestals, and center drawers
- Wire management. Covered metal channels, work surface and panel leg grommets, and “place it yourself” plastic wire management channels provide a complete wire management solution
- Clean lines. All modesty panels are single piece, to minimize vertical lines. Desk legs, pedestals, and full height modesty panels are identical in height so that horizontal lines are consistent
- Horizontal lines consistent with other products.

Detailed Component Specifications

23" and 29" Panel Leg Specifications

- Panel legs are non handed, and 27-3/4" high when leveling glides are fully recessed. Leveling glides provide 7/8" adjustment
- All panel legs are 1-1/2" wide so that work surface fasteners are positioned within the leg itself, allowing for storage to set snug against the leg
- 23" and 29" panel legs each require one gusset when no modesty panel is present
- Each leg is pre-drilled for both partial and full height modesty panel attachment
- All panel legs include (1) 18" plastic wire management channel that is equipped with adhesive strips and may be attached to a modesty panel, work surface, or storage cabinet
- 23" and 29" panel legs are available with or without two rectangular 3-1/2" x 2" plastic grommets (inside clear dimensions: 2-3/4" x 1-1/2"), positioned at the top of the leg
- Full height metal panel leg covers close-out vertical channels integrated into the panel legs (two per leg), and are sold separately. Each cover includes two grommets, located at top and bottom
- Panel legs and metal wire management covers consist of 20 gauge steel

Corner Leg Specifications

- “L” shaped corner leg is 7-1/2" x 7-1/2", and 1-1/2" wide so that work surface fasteners are positioned within the leg itself
- Corner legs are 27-3/4" high when leveling glides are fully recessed. Leveling glides provide 7/8" adjustment
- Each leg is pre-drilled for both partial and full height modesty attachment
- All corner legs include (1) 18" plastic wire management channel that is equipped with adhesive strips and may be attached to a modesty panel, work surface, or storage cabinet
- Metal wire management cover attaches and removes easily, closing out the triangular leg to capture wires within, and are sold separately
- Corner legs and covers consist of 20 gauge steel

Post Leg

- Post leg 27-3/4" high and 3" in diameter, with adjustable leveling glide
- Each leg is pre-drilled for both partial and full height modesty panel attachment

12" Panel Leg Specifications

- 12" panel legs are designed to sit perpendicular to the edge of the work surface, providing additional support and knee space. 12" panel legs may not be used at the end of work surface runs
- Unlike 23" and 29" panel legs, 12" panel legs do not require gussets when there is no modesty panel because they may not be used at the end of a work surface run
- 12" panel legs may also be used in mid-run to support two work surfaces simultaneously
- Each leg is pre-drilled on both sides for both partial and full height modesty panel attachment, and are unhandled
- All panel legs include (1) 18" plastic wire management channel that is equipped with adhesive strips and may be attached to a modesty panel, work surface, or storage cabinet
- A single grommet is included at the top of each 12" panel leg. Grommets are black plastic, 3-1/2" x 2" (inside clear dimensions: 2-3/4" x 1-1/2")
- A metal wire management cover is included with each 12" panel leg
- Panel legs and covers consist of 20 gauge steel

Gussets

- One gusset is required to support 23" and 29" panel legs when no modesty panel or pedestal positioned adjacent to the panel leg is present
- A gusset will prevent a mobile ped from sitting snugly against the panel leg
- Gussets consist of 18 gauge steel



Critical Dimensions:

Modesty Panel Specifications

- All Trace modesty panels are single-piece construction
- Modesty panels consist of 22 gauge steel, with forms on each edge for added strength and ease of attachment to panel legs and work surfaces

Modesty Panel Offset Brackets

- Modesty panels attach to pre-drilled holes located on the inside edges of panel legs. When a modesty panel must attach to the end of a panel leg, as with a return or bridge, then a modesty panel offset bracket is required to connect pre-drilled attachment points. Modesty panel offset brackets are included with returns and bridges, when ordered with modesty panels and are also sold separately

Work Surface Grommets

All TRACE work surfaces come standard with one or two grommets, which are black plastic with removable covers.

- Rectangular work surfaces 60" and narrower include one grommet in center
- Rectangular work surfaces 66" and wider include two grommets, with grommet center point 20" from each side edge
- Corner desks include one grommet in corner
- Peninsulas include two grommets centered on non-rounded end

Work Surface Over-Hang

Allow for 1/2" overhang on front, back, and sides of all desks. Work surfaces are pre-drilled for proper panel leg positioning

Work Surface Option

For large projects, it is possible to include metal inserts in work surfaces when required for attachment of panel legs, modesty panels, etc. Call for details

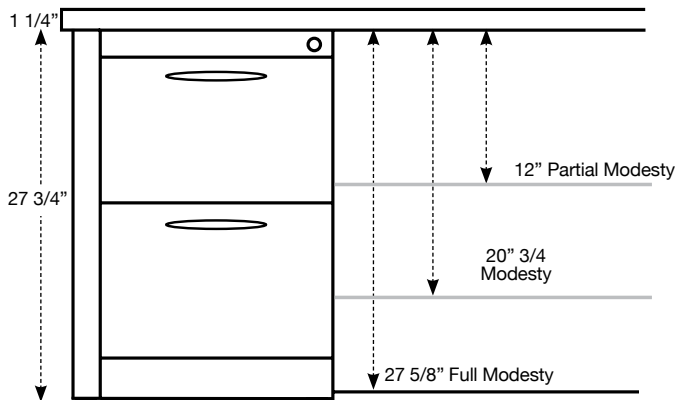

Work Surface Grommets

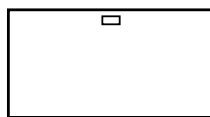
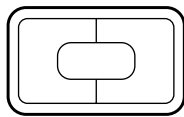
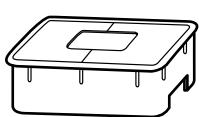

tops 60" or less
1 center grommet



66" or more
2 grommets

- A. Panel leg grommets available as an option with no up-charge
- B. Plastic wire management channels - one 18" channel included with each panel and corner leg
- C. Work surface grommets - one or two grommets included in all work surfaces
- D. Modesty panels in three heights allow wires to run beneath
- E. Wire management channel covers for panel legs & corner legs are sold separately

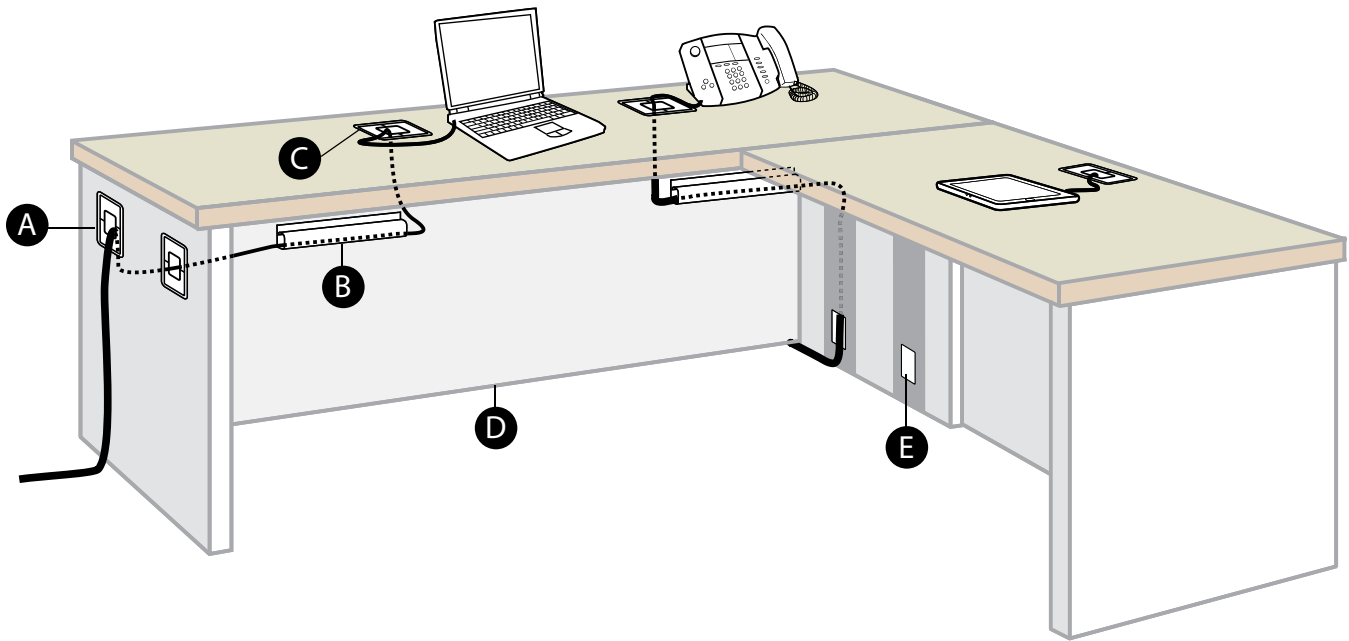

Our objective is to offer you our absolute lowest cost desk: no frills, with only the bare necessities. If you'd prefer a desk with modesty panels, please see our desk shell.

**Bare Bones
Single Pedestal
Desk**

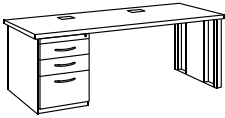

- One top with grommet (tops 60" or less = 1 grommet, 66" or more = 2 grommets)
- One pedestal with counterweight
- One panel leg with gusset
- No modesty panel
- Plastic wire management channel included with panel leg

H	D	W	Ped Depth	Drawer Options	Part #	Front	Part #	Metal Color	Lam/Edge #	Price
29	24	48	22	file/file	BBS	?	2 2448	?	?	\$2,287
				box/box/file	BBS	?	3 2448	?	?	\$2,349
29	24	54	22	file/file	BBS	?	2 2454	?	?	\$2,361
				box/box/file	BBS	?	3 2454	?	?	\$2,436
29	24	60	22	file/file	BBS	?	2 2460	?	?	\$2,446
				box/box/file	BBS	?	3 2460	?	?	\$2,516
29	24	66	22	file/file	BBS	?	2 2466	?	?	\$2,535
				box/box/file	BBS	?	3 2466	?	?	\$2,589
29	24	72	22	file/file	BBS	?	2 2472	?	?	\$2,557
				box/box/file	BBS	?	3 2472	?	?	\$2,633
29	30	48	28	file/file	BBS	?	2 3048	?	?	\$2,655
				box/box/file	BBS	?	3 3048	?	?	\$2,742
29	30	54	28	file/file	BBS	?	2 3054	?	?	\$2,707
				box/box/file	BBS	?	3 3054	?	?	\$2,796
29	30	60	28	file/file	BBS	?	2 3060	?	?	\$2,773
				box/box/file	BBS	?	3 3060	?	?	\$2,851
29	30	66	28	file/file	BBS	?	2 3066	?	?	\$2,837
				box/box/file	BBS	?	3 3066	?	?	\$2,894
29	30	72	28	file/file	BBS	?	2 3072	?	?	\$2,923
				box/box/file	BBS	?	3 3072	?	?	\$3,001

Available Fronts | A | B | D | F | H | I | N | P | Q | S

**Bare Bones
Double Pedestal
Desk**

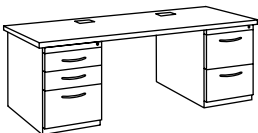

- One top with grommet (tops 60" or less = 1 grommet, 66" or more = 2 grommets)
- Two pedestals with counterweight
- One file/file, one box/box/file
- No panel legs
- No modesty panel

H	D	W	Ped Depth	Drawer Options	Part #	Front	Part #	Metal Color	Lam/Edge #	Price
29	24	60	22	one each	BBD	?	5 2460	?	?	\$2,472
29	24	66	22	one each	BBD	?	5 2466	?	?	\$2,529
29	24	72	22	one each	BBD	?	5 2472	?	?	\$2,585
29	30	60	28	one each	BBD	?	5 3060	?	?	\$2,668
29	30	66	28	one each	BBD	?	5 3066	?	?	\$2,717
29	30	72	28	one each	BBD	?	5 3072	?	?	\$2,767

Available Fronts | A | B | D | F | H | I | N | P | Q | S

**Bare Bones
Single Pedestal
Return**

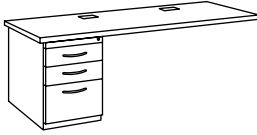

- One top with grommet (tops 60" or less = 1 grommet, 66" or more = 2 grommets)
- One pedestal with counterweight
- Two splice plates
- No panel legs
- No modesty panel

H	D	W	Ped Depth	Drawer Options	Part #	Front	Part #	Metal Color	Lam/Edge #	Price
29	24	30	22	file/file	BBR	?	2 2430	?	?	\$1,377
				box/box/file	BBR	?	3 2430	?	?	\$1,463
29	24	36	22	file/file	BBR	?	2 2436	?	?	\$1,422
				box/box/file	BBR	?	3 2436	?	?	\$1,510
29	24	42	22	file/file	BBR	?	2 2442	?	?	\$1,508
				box/box/file	BBR	?	3 2442	?	?	\$1,594
29	24	48	22	file/file	BBR	?	2 2448	?	?	\$1,515
				box/box/file	BBR	?	3 2448	?	?	\$1,602
29	24	60	22	file/file	BBR	?	2 2460	?	?	\$1,609
				box/box/file	BBR	?	3 2460	?	?	\$1,695
29	24	66	22	file/file	BBR	?	2 2466	?	?	\$1,668
				box/box/file	BBR	?	3 2466	?	?	\$1,753
29	24	72	22	file/file	BBR	?	2 2472	?	?	\$1,722
				box/box/file	BBR	?	3 2472	?	?	\$1,809

Available Fronts	A	B	D	F	H	I	N	P	Q	S
------------------	---	---	---	---	---	---	---	---	---	---

**Desk Shell
– No Modesty**

- One top with grommets (tops 60" or less = 1 center grommet, 66" or more = 2 grommets)
- Two panel legs (panel leg grommets optional, no up-charge)
- 36" work surfaces will include 29" panel legs, with 6" work surface overhang
- Two gussets (one per panel leg)
- No modesty panel
- Plastic wire management channels
- A gusset will prevent a mobile ped from sitting snugly against the panel leg
- Bow front work surfaces have a 6-1/2" overhang in the center

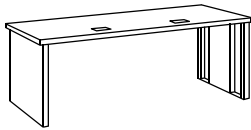

H	D	W	Part #	* = No grommet G= grommet	No Modesty	Metal Color	Lam/Edge	Price
29	24	30	DK 2430	?	N	?	?	\$1,631
29	24	36	DK 2436	?	N	?	?	\$1,673
29	24	42	DK 2442	?	N	?	?	\$1,760
29	24	48	DK 2448	?	N	?	?	\$1,784
29	24	54	DK 2454	?	N	?	?	\$1,826
29	24	60	DK 2460	?	N	?	?	\$1,893
29	24	66	DK 2466	?	N	?	?	\$1,989
29	24	72	DK 2472	?	N	?	?	\$2,022
29	30	30	DK 3030	?	N	?	?	\$1,851
29	30	36	DK 3036	?	N	?	?	\$1,883
29	30	42	DK 3042	?	N	?	?	\$1,926
29	30	48	DK 3048	?	N	?	?	\$1,957
29	30	54	DK 3054	?	N	?	?	\$2,033
29	30	60	DK 3060	?	N	?	?	\$2,101
29	30	66	DK 3066	?	N	?	?	\$2,166
29	30	72	DK 3072	?	N	?	?	\$2,252
29	36	48	DK 3648	?	N	?	?	\$2,166
29	36	60	DK 3660	?	N	?	?	\$2,241
29	36	66	DK 3666	?	N	?	?	\$2,371
29	36	72	DK 3672	?	N	?	?	\$2,459
29	36	72 (bow)	BDK 3672	?	N	?	?	\$2,504

**Desk Shell
– Partial Modesty**

- One top with grommets (tops 60" or less = 1 center grommet, 66" or more = 2 grommets)
- Two panel legs (panel leg grommets optional, no up-charge)
- 36" work surfaces will include 29" panel legs, with 6" work surface overhang
- Partial modesty panel is 12" tall, raised 17" from floor
- Modesty height designed to allow easy access to electrical outlets
- Plastic wire management channels
- Bow front work surfaces have a 6-1/2" overhang in the center

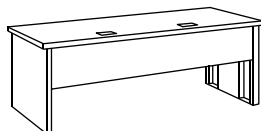

Hanging pedestals do not match the height of this modesty panel. Use 3/4 Modesty panel on next page.

H	D	W	Part #	* = No grommet G= grommet	Partial Modesty	Metal Color	Lam/Edge	Price
29	24	30	DK 2430	?	P	?	?	\$1,655
29	24	36	DK 2436	?	P	?	?	\$1,708
29	24	42	DK 2442	?	P	?	?	\$1,817
29	24	48	DK 2448	?	P	?	?	\$1,839
29	24	54	DK 2454	?	P	?	?	\$1,924
29	24	60	DK 2460	?	P	?	?	\$1,978
29	24	66	DK 2466	?	P	?	?	\$2,077
29	24	72	DK 2472	?	P	?	?	\$2,121
29	30	30	DK 3030	?	P	?	?	\$1,884
29	30	36	DK 3036	?	P	?	?	\$1,895
29	30	42	DK 3042	?	P	?	?	\$1,970
29	30	48	DK 3048	?	P	?	?	\$2,012
29	30	54	DK 3054	?	P	?	?	\$2,088
29	30	60	DK 3060	?	P	?	?	\$2,174
29	30	66	DK 3066	?	P	?	?	\$2,262
29	30	72	DK 3072	?	P	?	?	\$2,349
29	36	48	DK 3648	?	P	?	?	\$2,229
29	36	60	DK 3660	?	P	?	?	\$2,352
29	36	66	DK 3666	?	P	?	?	\$2,459
29	36	72	DK 3672	?	P	?	?	\$2,557
29	36	72 (bow)	BDK 3672	?	P	?	?	\$2,589

**Desk Shell
– 3/4 Modesty**

- 3/4 modesty bottom is even with hanging box/file ped
- One top with grommets (tops 60" or less = 1 center grommet, 66" or more = 2 grommets)
- Two panel legs (panel leg grommets optional, no up-charge)
- Plastic wire management channels

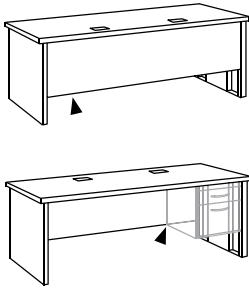

H	D	W	Part #	* = No grommet G= grommet	3/4 Height Modesty	Metal Color	Lam/Edge	Price
29	24	30	DK 2430	?	T	?	?	\$1,678
29	24	36	DK 2436	?	T	?	?	\$1,734
29	24	42	DK 2442	?	T	?	?	\$1,846
29	24	48	DK 2448	?	T	?	?	\$1,868
29	24	54	DK 2454	?	T	?	?	\$1,953
29	24	60	DK 2460	?	T	?	?	\$2,009
29	24	66	DK 2466	?	T	?	?	\$2,111
29	24	72	DK 2472	?	T	?	?	\$2,152
29	30	30	DK 3030	?	T	?	?	\$1,911
29	30	36	DK 3036	?	T	?	?	\$1,922
29	30	42	DK 3042	?	T	?	?	\$1,998
29	30	48	DK 3048	?	T	?	?	\$2,044
29	30	54	DK 3054	?	T	?	?	\$2,119
29	30	60	DK 3060	?	T	?	?	\$2,209
29	30	66	DK 3066	?	T	?	?	\$2,297
29	30	72	DK 3072	?	T	?	?	\$2,383

**Desk Shell
– Full Modesty**

- One top with grommets (tops 60" or less = 1 center grommet, 66" or more = 2 grommets)
- Two panel legs (panel leg grommets optional, no up-charge)
- 36" work surfaces will include 29" panel legs, with 6" work surface overhang
- Full height modesty panel is 27-5/8" tall, raised 1/2" from floor
- Plastic wire management channels
- Bow front work surfaces have a 6-1/2" overhang in the center

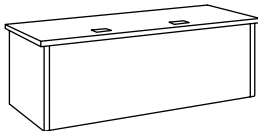

**Optional Panel Leg Grommets
(covers sold separately)**

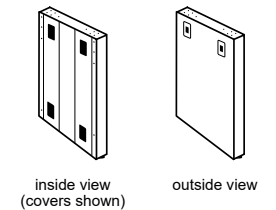

H	D	W	Part #	* = No grommet G= grommet	Full Modesty	Metal Color	Lam/Edge	Price
29	24	30	DK 2430	?	F	?	?	\$1,697
29	24	36	DK 2436	?	F	?	?	\$1,763
29	24	42	DK 2442	?	F	?	?	\$1,883
29	24	48	DK 2448	?	F	?	?	\$1,915
29	24	54	DK 2454	?	F	?	?	\$1,971
29	24	60	DK 2460	?	F	?	?	\$2,054
29	24	66	DK 2466	?	F	?	?	\$2,179
29	24	72	DK 2472	?	F	?	?	\$2,229
29	30	30	DK 3030	?	F	?	?	\$1,926
29	30	36	DK 3036	?	F	?	?	\$1,949
29	30	42	DK 3042	?	F	?	?	\$2,033
29	30	48	DK 3048	?	F	?	?	\$2,088
29	30	54	DK 3054	?	F	?	?	\$2,154
29	30	60	DK 3060	?	F	?	?	\$2,262
29	30	66	DK 3066	?	F	?	?	\$2,349
29	30	72	DK 3072	?	F	?	?	\$2,459
29	36	48	DK 3648	?	F	?	?	\$2,297
29	36	60	DK 3660	?	F	?	?	\$2,416
29	36	66	DK 3666	?	F	?	?	\$2,569
29	36	72	DK 3672	?	F	?	?	\$2,666
29	36	72 (bow)	BDK 3672	?	F	?	?	\$2,711

**Return Shell
– No Modesty**

- One top with grommets (tops 60" or less = 1 center grommet, 66" or more = 2 grommets)
- One panel leg (panel leg grommets optional, no up-charge)
- No modesty panel
- Two splice plates
- One gusset
- Plastic wire management channel
- Non-handed

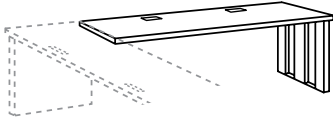

H	D	W	Part #	* = No grommet G= grommet	No Modesty	Metal Color	Lam/Edge #	Price
29	24	24	RT 2424	?	N	?	?	\$1,214
29	24	30	RT 2430	?	N	?	?	\$1,240
29	24	36	RT 2436	?	N	?	?	\$1,295
29	24	42	RT 2442	?	N	?	?	\$1,380
29	24	48	RT 2448	?	N	?	?	\$1,394
29	24	54	RT 2454	?	N	?	?	\$1,421
29	24	60	RT 2460	?	N	?	?	\$1,502
29	24	66	RT 2466	?	N	?	?	\$1,599
29	24	72	RT 2472	?	N	?	?	\$1,642
29	30	30	RT 3030	?	N	?	?	\$1,438
29	30	36	RT 3036	?	N	?	?	\$1,438
29	30	42	RT 3042	?	N	?	?	\$1,501
29	30	48	RT 3048	?	N	?	?	\$1,543
29	30	54	RT 3054	?	N	?	?	\$1,609
29	30	60	RT 3060	?	N	?	?	\$1,673
29	30	66	RT 3066	?	N	?	?	\$1,740
29	30	72	RT 3072	?	N	?	?	\$1,826

**Return Shell
– Partial Modesty**

- One top with grommets (tops 60" or less = 1 center grommet, 66" or more = 2 grommets)
- One panel leg (panel leg grommets optional, no up-charge)
- Partial modesty is 12" tall, raised 17" from the floor
- Two splice plates
- Modesty panel
- Modesty panel offset brackets
- Plastic wire management channel
- Non-handed

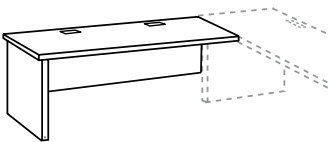

H	D	W	Part #	* = No grommet G= grommet	Partial Modesty	Metal Color	Lam/Edge #	Price
29	24	24	RT 2424	?	P	?	?	\$1,239
29	24	30	RT 2430	?	P	?	?	\$1,276
29	24	36	RT 2436	?	P	?	?	\$1,339
29	24	42	RT 2442	?	P	?	?	\$1,438
29	24	48	RT 2448	?	P	?	?	\$1,458
29	24	54	RT 2454	?	P	?	?	\$1,508
29	24	60	RT 2460	?	P	?	?	\$1,555
29	24	66	RT 2466	?	P	?	?	\$1,668
29	24	72	RT 2472	?	P	?	?	\$1,709
29	30	30	RT 3030	?	P	?	?	\$1,470
29	30	36	RT 3036	?	P	?	?	\$1,479
29	30	42	RT 3042	?	P	?	?	\$1,555
29	30	48	RT 3048	?	P	?	?	\$1,590
29	30	54	RT 3054	?	P	?	?	\$1,671
29	30	60	RT 3060	?	P	?	?	\$1,753
29	30	66	RT 3066	?	P	?	?	\$1,817
29	30	72	RT 3072	?	P	?	?	\$1,915

**Return Shell –
Full Modesty**

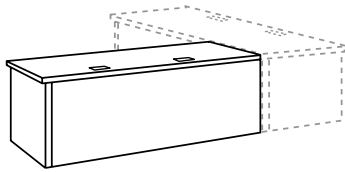

- One top with grommets (tops 60" or less = 1 center grommet, 66" or more = 2 grommets)
- One panel leg (panel leg grommets optional, no up-charge)
- Full modesty is 27-5/8" tall, raised 1/2" from the floor
- Two splice plates
- Modesty panel offset brackets
- Plastic wire management channel
- Non-handed

Optional Panel Leg
Grommets
(covers sold
separately)

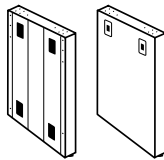

inside view
(covers shown) outside view

H	D	W	Part #	* = No grommet G= grommet	Full Modesty	Metal Color	Lam/Edge #	Price
29	24	24	RT 2424	?	F	?	?	\$1,293
29	24	30	RT 2430	?	F	?	?	\$1,325
29	24	36	RT 2436	?	F	?	?	\$1,392
29	24	42	RT 2442	?	F	?	?	\$1,501
29	24	48	RT 2448	?	F	?	?	\$1,535
29	24	54	RT 2454	?	F	?	?	\$1,610
29	24	60	RT 2460	?	F	?	?	\$1,687
29	24	66	RT 2466	?	F	?	?	\$1,807
29	24	72	RT 2472	?	F	?	?	\$1,861
29	30	30	RT 3030	?	F	?	?	\$1,513
29	30	36	RT 3036	?	F	?	?	\$1,535
29	30	42	RT 3042	?	F	?	?	\$1,620
29	30	48	RT 3048	?	F	?	?	\$1,687
29	30	54	RT 3054	?	F	?	?	\$1,772
29	30	60	RT 3060	?	F	?	?	\$1,861
29	30	66	RT 3066	?	F	?	?	\$1,937
29	30	72	RT 3072	?	F	?	?	\$2,045

**“D” & “P” Peninsula
– No Modesty**

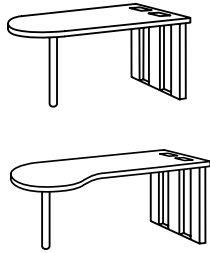

- One top with grommets
- One post leg
- One panel leg (panel leg grommets optional, no up-charge)
- One gusset
- No modesty panel
- Plastic wire management channel

When adding a return, bridge, or peninsula to a single ped desk (L-Station), the single ped desk should be at least 66" wide to leave adequate knee space. Peninsulas are not freestanding units; they must attach to bridge, desk shell, or return.

H	A	B	C	Top Shape	Part #	* = No grommet G= grommet	No Modesty	Metal Color	Lam/ Edge #	Price
29	30	60	30	“D”	PD 3060	?	N	?	?	\$1,949
29	30	66	30	“D”	PD 3066	?	N	?	?	\$2,121
29	30	72	30	“D”	PD 3072	?	N	?	?	\$2,132
29	30	60	36	“P” left	PNL 3060	?	N	?	?	\$2,633
29	30	66	36	“P” left	PNL 3066	?	N	?	?	\$2,796
29	30	72	36	“P” left	PNL 3072	?	N	?	?	\$2,806
29	30	60	36	“P” right	PNR 3060	?	N	?	?	\$2,633
29	30	66	36	“P” right	PNR 3066	?	N	?	?	\$2,796
29	30	72	36	“P” right	PNR 3072	?	N	?	?	\$2,806

**“D” & “P” Peninsula
– Partial Modesty**

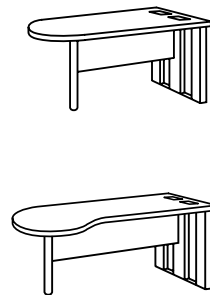

- One top with grommets
- One post leg
- One panel leg (panel leg grommets optional, no up-charge)
- Partial height modesty panel is 12" tall, raised 17" from floor
- Plastic wire management channel

H	A	B	C	Top Shape	Part #	* = No grommet G= grommet	Partial Modesty	Metal Color	Lam/ Edge #	Price
29	30	60	30	“D”	PD 3060	?	P	?	?	\$2,077
29	30	66	30	“D”	PD 3066	?	P	?	?	\$2,252
29	30	72	30	“D”	PD 3072	?	P	?	?	\$2,284
29	30	60	36	“P” left	PNL 3060	?	P	?	?	\$2,765
29	30	66	36	“P” left	PNL 3066	?	P	?	?	\$2,923
29	30	72	36	“P” left	PNL 3072	?	P	?	?	\$2,949
29	30	60	36	“P” right	PNR 3060	?	P	?	?	\$2,765
29	30	66	36	“P” right	PNR 3066	?	P	?	?	\$2,923
29	30	72	36	“P” right	PNR 3072	?	P	?	?	\$2,949

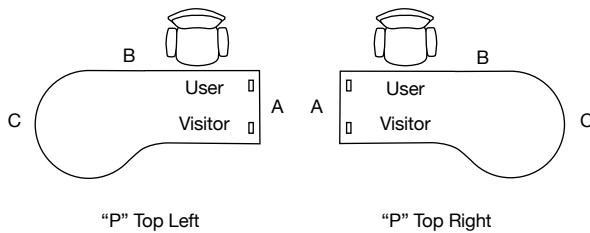

Optional Panel Leg Grommets
(covers sold separately)

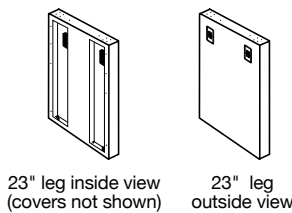

**Corner
– No Modesty**

- One top with grommet
- One corner leg
- Two 12" panel legs include grommet and panel leg covers
- No modesty panels
- Plastic wire management channels

A corner may not be used as a stand-alone or end-of-run desk; it must be attached on both sides to a bridge or return.

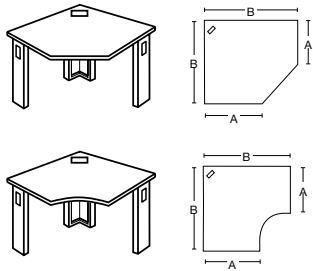

H	A	B	User Edge	Part #	Metal Color	Lam/Edge #	Price
29	24	36	straight	CS 2436 N	?	?	\$2,361
29	24	42	straight	CS 2442 N	?	?	\$2,632
29	24	48	straight	CS 2448 N	?	?	\$2,664
29	24	36	curved	CC 2436 N	?	?	\$2,361
29	24	42	curved	CC 2442 N	?	?	\$2,632
29	24	48	curved	CC 2448 N	?	?	\$2,664

**Corner
– Partial Modesty**

- One top with grommet
- One corner leg
- Two 12" panel legs include grommet and panel leg covers
- Partial height modesty panels are 12" tall, raised 17" from the floor
- Plastic wire management channels

A corner may not be used as a stand-alone or end-of-run desk; it must be attached on both sides to a bridge or return.

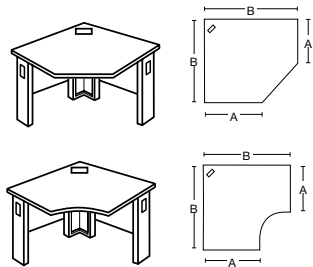

H	A	B	User Edge	Part #	Metal Color	Lam/Edge #	Price
29	24	36	straight	CS 2436 P	?	?	\$2,732
29	24	42	straight	CS 2442 P	?	?	\$3,014
29	24	48	straight	CS 2448 P	?	?	\$3,070
29	24	36	curved	CC 2436 P	?	?	\$2,732
29	24	42	curved	CC 2442 P	?	?	\$3,014
29	24	48	curved	CC 2448 P	?	?	\$3,070

**Corner
– Full Modesty**

- One top with grommet
- One corner leg
- Two 12" panel legs include grommet and panel leg covers
- Full height modesty panels are 27-5/8" tall, raised 1/2" from the floor
- Plastic wire management channels

A corner may not be used as a stand-alone or end-of-run desk; it must be attached on both sides to a bridge or return.

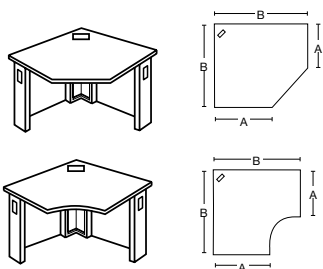

H	A	B	User Edge	Part #	Metal Color	Lam/Edge #	Price
29	24	36	straight	CS 2436 F	?	?	\$2,819
29	24	42	straight	CS 2442 F	?	?	\$3,120
29	24	48	straight	CS 2448 F	?	?	\$3,200
29	24	36	curved	CC 2436 F	?	?	\$2,819
29	24	42	curved	CC 2442 F	?	?	\$3,120
29	24	48	curved	CC 2448 F	?	?	\$3,200

**Corner Leg Wire
Management Cover**

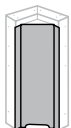

- Metal cover closes out the triangular corner legs to safely enclose cables. Magnetic attachment allows for easy removal and replacement
- Please specify color

Product	Qty	Part #	Price
Corner Leg Cover (Specify Color)	Pkg. of 1 cover	GOC 151 K ?	\$101

TRACE DESKS

SIN 33721

Extended Corner No Modesty

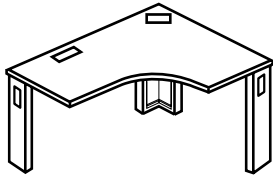

An extended corner that does not include an end-of-run 24" or 30" deep panel leg (see next page) may not be used as a stand-alone desk, it must be attached to a bridge or return on both sides. For end-of-run applications, see the following page.

- One top with grommet
- One corner leg, two 12" panel legs
- Two 12" panel legs include grommet and panel leg covers
- No modesty panels
- Plastic wire management channels

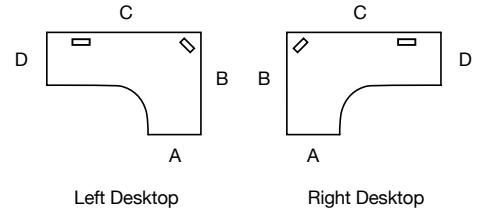

H	A	B	C	D	Part #	L/R	Part #	Metal Color	Lam/Edge #	Price
29	24	48	60	24	ET	L/R	24 60 24 N	?	?	\$3,283
29	24	48	66	24	ET	L/R	24 66 24 N	?	?	\$3,358
29	24	48	72	24	ET	L/R	24 72 24 N	?	?	\$3,481
29	24	48	60	30	ET	L/R	24 60 30 N	?	?	\$3,283
29	24	48	66	30	ET	L/R	24 66 30 N	?	?	\$3,358
29	24	48	72	30	ET	L/R	24 72 30 N	?	?	\$3,481
29	30	48	60	24	ET	L/R	30 60 24 N	?	?	\$3,283
29	30	48	66	24	ET	L/R	30 66 24 N	?	?	\$3,358
29	30	48	72	24	ET	L/R	30 72 24 N	?	?	\$3,481
29	30	48	60	30	ET	L/R	30 60 30 N	?	?	\$3,283
29	30	48	66	30	ET	L/R	30 66 30 N	?	?	\$3,358
29	30	48	72	30	ET	L/R	30 72 30 N	?	?	\$3,481

Extended Corner Partial Modesty

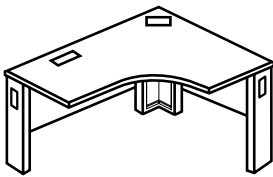

- One top with grommet
- One corner leg, two 12" panel legs
- Two 12" panel legs include grommet and panel leg covers
- Partial height modesty panels are 12" tall, raised 17" from floor
- Plastic wire management channels

H	A	B	C	D	Part #	L/R	Part #	Metal Color	Lam/Edge #	Price
29	24	48	60	24	ET	L/R	24 60 24 P	?	?	\$3,699
29	24	48	66	24	ET	L/R	24 66 24 P	?	?	\$3,800
29	24	48	72	24	ET	L/R	24 72 24 P	?	?	\$3,916
29	24	48	60	30	ET	L/R	24 60 30 P	?	?	\$3,699
29	24	48	66	30	ET	L/R	24 66 30 P	?	?	\$3,800
29	24	48	72	30	ET	L/R	24 72 30 P	?	?	\$3,916
29	30	48	60	24	ET	L/R	30 60 24 P	?	?	\$3,699
29	30	48	66	24	ET	L/R	30 66 24 P	?	?	\$3,800
29	30	48	72	24	ET	L/R	30 72 24 P	?	?	\$3,916
29	30	48	60	30	ET	L/R	30 60 30 P	?	?	\$3,699
29	30	48	66	30	ET	L/R	30 66 30 P	?	?	\$3,800
29	30	48	72	30	ET	L/R	30 72 30 P	?	?	\$3,916

Extended Corner Full Modesty

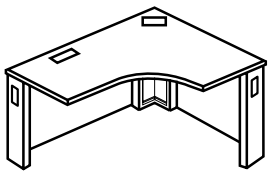

- One top with grommet
- One corner leg, two 12" panel legs
- Two 12" panel legs include grommet and panel leg covers
- Full height modesty panels are 27-5/8" tall, raised 1/2" from floor
- Plastic wire management channels

H	A	B	C	D	Part #	L/R	Part #	Metal Color	Lam/Edge #	Price
29	24	48	60	24	ET	L/R	24 60 24 F	?	?	\$3,850
29	24	48	66	24	ET	L/R	24 66 24 F	?	?	\$3,968
29	24	48	72	24	ET	L/R	24 72 24 F	?	?	\$4,090
29	24	48	60	30	ET	L/R	24 60 30 F	?	?	\$3,850
29	24	48	66	30	ET	L/R	24 66 30 F	?	?	\$3,968
29	24	48	72	30	ET	L/R	24 72 30 F	?	?	\$4,090
29	30	48	60	24	ET	L/R	30 60 24 F	?	?	\$3,850
29	30	48	66	24	ET	L/R	30 66 24 F	?	?	\$3,968
29	30	48	72	24	ET	L/R	30 72 24 F	?	?	\$4,090
29	30	48	60	30	ET	L/R	30 60 30 F	?	?	\$3,850
29	30	48	66	30	ET	L/R	30 66 30 F	?	?	\$3,968
29	30	48	72	30	ET	L/R	30 72 30 F	?	?	\$4,090

End-of-run corners are designed with a 23" or 29" panel leg located on the "D" side of the corner desk. This panel allows desking runs to be terminated at the corner in a way that ensures stability and offers a clean, finished look. An end-of-run may be used as an end run, it must be attached to a bridge or return on the side with the 12" panel leg.

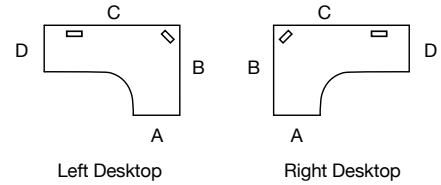

**End-of-Run
Extended Corner -
No Modesty**

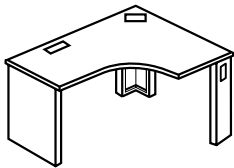

- One top with grommet
- One corner leg, one 12" panel leg, and one 23" or 29" panel leg
- No modesty panels
- Plastic wire management channels
- One gusset

H	A	B	C	D	Part #	L/R	Part #	Metal Color	Lam/Edge #	Price
29	24	48	60	24	ED	L/R	24 60 24 N	?	?	\$3,525
29	24	48	66	24	ED	L/R	24 66 24 N	?	?	\$3,608
29	24	48	72	24	ED	L/R	24 72 24 N	?	?	\$3,703
29	24	48	60	30	ED	L/R	24 60 30 N	?	?	\$3,550
29	24	48	66	30	ED	L/R	24 66 30 N	?	?	\$3,661
29	24	48	72	30	ED	L/R	24 72 30 N	?	?	\$3,735
29	30	48	60	24	ED	L/R	30 60 24 N	?	?	\$3,550
29	30	48	66	24	ED	L/R	30 66 24 N	?	?	\$3,652
29	30	48	72	24	ED	L/R	30 72 24 N	?	?	\$3,733
29	30	48	60	30	ED	L/R	30 60 30 N	?	?	\$3,581
29	30	48	66	30	ED	L/R	30 66 30 N	?	?	\$3,706
29	30	48	72	30	ED	L/R	30 72 30 N	?	?	\$3,763

**End-of-Run
Extended Corner -
Partial Modesty**

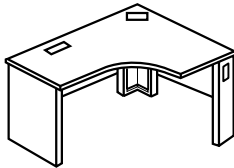

- One top with grommet
- One corner leg, one 12" panel leg, and one 23" or 29" panel leg
- Partial height modesty panels are 12" tall, raised 17" from floor
- Plastic wire management channels

H	A	B	C	D	Part #	L/R	Part #	Metal Color	Lam/Edge #	Price
29	24	48	60	24	ED	L/R	24 60 24 P	?	?	\$3,936
29	24	48	66	24	ED	L/R	24 66 24 P	?	?	\$4,036
29	24	48	72	24	ED	L/R	24 72 24 P	?	?	\$4,139
29	24	48	60	30	ED	L/R	24 60 30 P	?	?	\$3,964
29	24	48	66	30	ED	L/R	24 66 30 P	?	?	\$4,064
29	24	48	72	30	ED	L/R	24 72 30 P	?	?	\$4,171
29	30	48	60	24	ED	L/R	30 60 24 P	?	?	\$3,936
29	30	48	66	24	ED	L/R	30 66 24 P	?	?	\$4,086
29	30	48	72	24	ED	L/R	30 72 24 P	?	?	\$4,139
29	30	48	60	30	ED	L/R	30 60 30 P	?	?	\$3,964
29	30	48	66	30	ED	L/R	30 66 30 P	?	?	\$4,116
29	30	48	72	30	ED	L/R	30 72 30 P	?	?	\$4,164

**End-of-Run
Extended Corner -
Full Modesty**

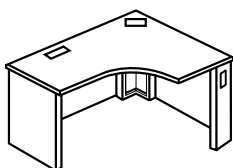

- One top with grommet
- One corner leg, one 12" panel leg, and one 23" or 29" panel leg
- Full height modesty panels are 27-5/8" tall, raised 1/2" from floor
- Plastic wire management channels

H	A	B	C	D	Part #	L/R	Part #	Metal Color	Lam/Edge #	Price
29	24	48	60	24	ED	L/R	24 60 24 F	?	?	\$4,090
29	24	48	66	24	ED	L/R	24 66 24 F	?	?	\$4,200
29	24	48	72	24	ED	L/R	24 72 24 F	?	?	\$4,325
29	24	48	60	30	ED	L/R	24 60 30 F	?	?	\$4,120
29	24	48	66	30	ED	L/R	24 66 30 F	?	?	\$4,250
29	24	48	72	30	ED	L/R	24 72 30 F	?	?	\$4,354
29	30	48	60	24	ED	L/R	30 60 24 F	?	?	\$4,090
29	30	48	66	24	ED	L/R	30 66 24 F	?	?	\$4,200
29	30	48	72	24	ED	L/R	30 72 24 F	?	?	\$4,325
29	30	48	60	30	ED	L/R	30 60 30 F	?	?	\$4,120
29	30	48	66	30	ED	L/R	30 66 30 F	?	?	\$4,237
29	30	48	72	30	ED	L/R	30 72 30 F	?	?	\$4,354

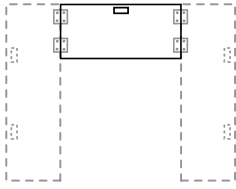

Bridges attach to desk shells, single pedestal desks, corner desks, and peninsulas to form a U-shaped configuration. Bridges cannot attach to returns or single pedestal returns. When adding a bridge to a single pedestal desk (L-Station), the single pedestal desk should be at least 66" wide to leave adequate knee space.

**Bridge
– No Modesty**

- One top with grommet (tops 60" or less = 1 center grommet, 66" or more = 2 grommets)
- Four splice plates
- No modesty panels

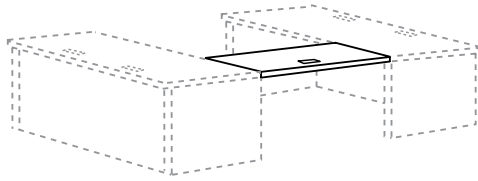

H	D	W	Part #	Lam/ Edge #	Price
29	24	24	BR 2424 N	?	\$651
29	24	30	BR 2430 N	?	\$683
29	24	36	BR 2436 N	?	\$725
29	24	42	BR 2442 N	?	\$820
29	24	48	BR 2448 N	?	\$832
29	24	60	BR 2460 N	?	\$936
29	24	66	BR 2466 N	?	\$1,032
29	24	72	BR 2472 N	?	\$1,072

**Bridge
– Partial Modesty**

- One top with grommet (tops 60" or less = 1 center grommet, 66" or more = 2 grommets)
- Four splice plates
- Partial height modesty panels are 12" tall, raised 17" from floor
- Modesty panel offset brackets

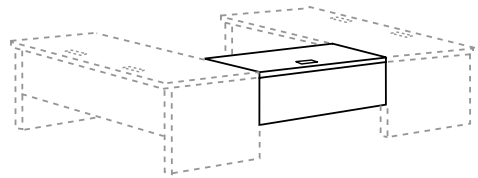

H	D	W	Part #	Metal Color	Lam/ Edge #	Price
29	24	24	BR 2424 P	?	?	\$903
29	24	30	BR 2430 P	?	?	\$947
29	24	36	BR 2436 P	?	?	\$1,002
29	24	42	BR 2442 P	?	?	\$1,098
29	24	48	BR 2448 P	?	?	\$1,123
29	24	60	BR 2460 P	?	?	\$1,252
29	24	66	BR 2466 P	?	?	\$1,361
29	24	72	BR 2472 P	?	?	\$1,404

**Bridge
– Full Modesty**

- One top with grommet (tops 60" or less = 1 center grommet, 66" or more = 2 grommets)
- Four splice plates
- Full height modesty panels are 27-5/8" tall, raised 1/2" from floor
- Modesty panel offset brackets

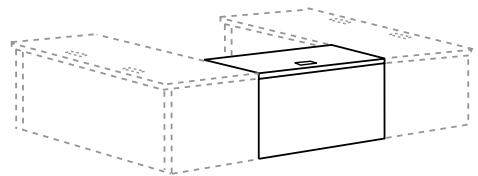

H	D	W	Part #	Metal Color	Lam/ Edge #	Price
29	24	24	BR 2424 F	?	?	\$947
29	24	30	BR 2430 F	?	?	\$990
29	24	36	BR 2436 F	?	?	\$1,058
29	24	42	BR 2442 F	?	?	\$1,175
29	24	48	BR 2448 F	?	?	\$1,209
29	24	60	BR 2460 F	?	?	\$1,349
29	24	66	BR 2466 F	?	?	\$1,470
29	24	72	BR 2472 F	?	?	\$1,521

Desk Component Note and Warranty Disclaimer:

Desk components are provided for customer convenience when creating customized desk configurations. It is exclusively the customer's responsibility to select the correct components and component sizes, and to ensure product safety and stability in the application of these components.

Please see the TRACE Desk Assembly Guide (supplied with each order) for proper placement, sequence and tools for connecting support legs, modesty panels, and work surfaces. See the TRACE Freestanding Desk FAQ's for a detailed description of the components listed here.

**TRACE Panel Leg
(non-handed)**

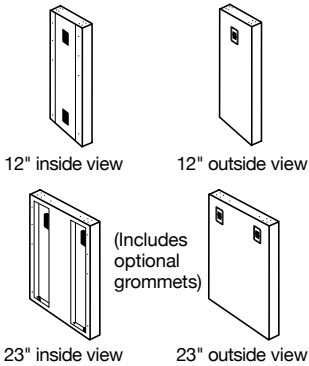

- Each 12" panel leg includes (1) 18" plastic wire management channel, (1) metal wire management cover, and a single centered grommet at the top of the leg
- Each 23" and 29" panel leg includes (1) 18" plastic wire management channel. Metal wire management covers are sold separately (see below)
- Panel legs may be ordered to include two rectangular plastic grommets, positioned at the top of the leg. Add the suffix "G" to include these grommets (no extra charge)
- Leveling glides provide 7/8" adjustment

Description	Pkg Wt	Pkg Cube	Part #	Metal Color	* = No grommet G= grommet	Price
(1) 12" panel leg	11.5 lb	.3 ft	GOL 1201	?	?	\$470
(2) 12" panel leg	25 lb	.8 ft	GOL 1202	?	?	\$937
(1) 23" panel leg	17 lb	.6 ft	GOL 2401	?	?	\$470
(2) 23" panel leg	37 lb	1.5 ft	GOL 2402	?	?	\$937
(1) 29" panel leg	23 lb	1.1 ft	GOL 3001	?	?	\$513
(2) 29" panel leg	46 lb	2.2 ft	GOL 3002	?	?	\$1,029

**TRACE Panel Leg Wire
Management Cover**

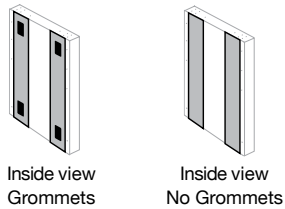

- Provides a finished look for panel leg
- For use on the 23" and 29" panel legs, two covers needed per leg.
- Covers with grommets include two grommets with edge protectors, one each located at top and bottom of each cover
- Specify with or without grommets

Product	Qty	Pkg Wt	Pkg Cube	Part #	Metal Color	Grommets	Price
panel leg cover	pkg. of 2 covers with grommets	4 lb	.2 ft	GCV 0002	?	Yes	\$116
	pkg. of 4 covers with grommets	8 lb	.2 ft	GCV 0004	?	Yes	\$230
panel leg cover	pkg. of 2 covers without grommets	4 lb	.2 ft	GCN 0002	?	No	\$116
	pkg. of 4 covers without grommets	8 lb	.2 ft	GCN 0004	?	No	\$230

TRACE Corner Leg



- Each corner leg includes (1) 18" plastic wire management channel. Corner leg wire management cover is sold separately
- Leveling glides provide 7/8" adjustment

Product	Qty	Pkg Wt	Pkg Cube	Part #	Metal Color	Price
corner leg	pkg. of 1 leg	8.7 lb	1.1 ft	GOC 01 K	?	\$346

**TRACE Corner Leg
Wire Management
Cover**

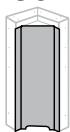

- Attaches magnetically to corner leg

Product	Qty	Pkg Wt	Pkg Cube	Part #	Metal Color	Price
corner leg cover	pkg. of 1 cover	2 lb	.2 ft	GOC 151 K	?	\$101

Panel Leg Gusset



- One gusset is required per 23" or 29" panel leg when no modesty panel or adjacent storage cabinet is present

Product	Qty	Pkg Wt	Pkg Cube	Part #	Metal Color	Price
gussets	pkg. of 1 gusset	1.1 lb	.1 ft	GUS 01 K	?	\$85
	pkg. of 2 gussets	2.2 lb	.2 ft	GUS 02 K	?	\$168

Post Leg

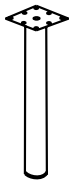

- Post leg is 3" diameter and 27-3/4" high Includes leveling glide
- Pre-drilled to accommodate partial and full-height modesty panels
- Leveling glides provide 7/8" adjustment

Product	Qty	Pkg Wt	Pkg Cube	Part #	Metal Color	Price
post leg (specify color)	pkg. of 1 leg	7 lb	.8 ft	GSK 0036	?	\$376

"H" Leg

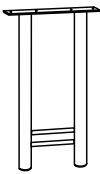

- For use with work surfaces 24" to 30" deep
- H leg is 27-3/4" high, with leveling glides
- Top plate is 6" x 18"
- Leg width is 16"

Product	Qty	Pkg Wt	Pkg Cube	Part #	Metal Color	Price
"h" leg (specify color)	pkg. of 1 leg	15 lb	2.0 ft	GHL 2214	?	\$838

Splice Plate

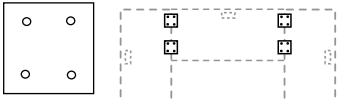

- Connect two work surfaces at 90 degree angles to one another. 4" x 4"

Product	Qty	Pkg Wt	Pkg Cube	Part #	Price
splice plates (black)	pkg. of 2 plates	1.1 lb	.01 ft	GSP 02 K	\$66

Modesty Panel
Offset Bracket

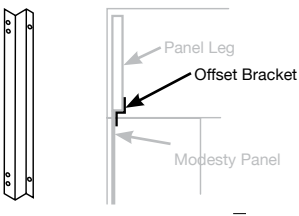

- For use when attaching a modesty panel to the end of a panel leg, as with a return or bridge. Specify bracket for full-height or partial height modesty panel

Product	Qty	Pkg Wt	Pkg Cube	Part #	Metal Color	Price
full-height bracket (specify color)	pkg. of 1 bracket	2 lb	2.0 ft	MPBF 01 K	?	\$92
partial-height bracket (specify color)	pkg. of 1 bracket	2 lb	2.0 ft	MPBH 01 K	?	\$81

Panel Leg /
Pedestal Bracket

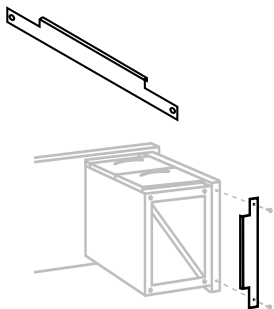



- Securely attaches pedestal to bottom of a panel leg. For use during rugged furniture rearrangement
- Bracket is black

Product	Qty	Pkg Wt	Pkg Cube	Part #	Metal Color	Price
23" panel leg bracket	pkg. of 1 bracket	.5 lb	1.0 ft	PLB 2401 K	?	\$68
23" panel leg bracket	pkg. of 2 brackets	1 lb	1.0 ft	PLB 2402 K	?	\$138
29" panel leg bracket	pkg. of 1 bracket	.8 lb	1.0 ft	PLB 3001 K	?	\$81
29" panel leg bracket	pkg. of 2 brackets	1.6 lb	1.0 ft	PLB 3002 K	?	\$161

Panel leg leveling glides screw through bracket back into panel leg to secure bracket to both pedestal and leg

Modesty Panels

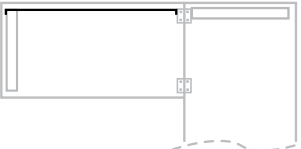
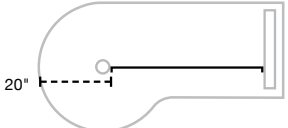
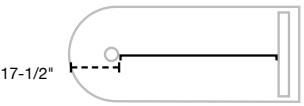
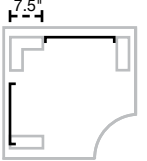
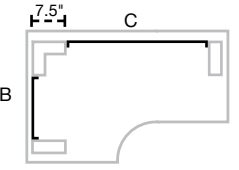
All TRACE modesty panels are single piece 22 gauge metal. Pre-drilled for quick installation with any size panel leg or corner leg. Full height modesty panels are 27-5/8" high, partial height are 12" high. Plan for 1/2" work surface overhang on all sides of legs, modesty panels, and case goods. Panel legs are 1-1/2" thick. Please specify metal color.

Modesty Panel Position	Mod. Width	Pkg Wt	Pkg Cube	Full Height Part #	Metal Color	Full Height Price	Partial Height Part #	Metal Color	Partial Height Price	
 <p>Desk Shells</p> <p>Modesty is 4" narrower than work surface width.</p>	30" wide	26"	9 lb	0.7 ft	GKM 2627	?	\$276	GKM 2612 ?	?	\$193
	36" wide	32"	11 lb	0.8 ft	GKM 3227	?	\$296	GKM 3212 ?	?	\$210
	42" wide	38"	13 lb	0.9 ft	GKM 3827	?	\$331	GKM 3812 ?	?	\$217
	48" wide	44"	15 lb	1.1 ft	GKM 4427	?	\$356	GKM 4412 ?	?	\$225
	54" wide	50"	17 lb	1.2 ft	GKM 5027	?	\$376	GKM 5012 ?	?	\$228
	60" wide	56"	20 lb	1.4 ft	GKM 5627	?	\$402	GKM 5612 ?	?	\$241
	66" wide	62"	22 lb	1.5 ft	GKM 6227	?	\$421	GKM 6212 ?	?	\$252
 <p>Return Shells and Transitional Returns</p> <p>Modesty is 1.5" narrower than work surface width.</p>	30" wide	28.5"	10 lb	0.7 ft	GKM 2827	?	\$283	GKM 2812	?	\$262
	36" wide	34.5"	12 lb	0.9 ft	GKM 3427	?	\$311	GKM 3412	?	\$210
	42" wide	40.5"	14 lb	1.0 ft	GKM 4027	?	\$331	GKM 4012	?	\$217
	48" wide	46.5"	16.5 lb	1.2 ft	GKM 4627	?	\$356	GKM 4612	?	\$225
	60" wide	58.5"	20.5 lb	1.5 ft	GKM 5827	?	\$393	GKM 5812	?	\$241
	66" wide	64.5"	22.5 lb	1.6 ft	GKM 6427	?	\$435	GKM 6412	?	\$252
	72" wide	70.5"	25 lb	1.7 ft	GKM 7027	?	\$458	GKM 7012	?	\$262
 <p>"P" Peninsulas</p> <p>Modesty is 20" narrower than work surface width.</p>	60" wide	38"	14 lb	1.0 ft	Full Height Modesty not available		GKM 3812	?	\$217	
	66" wide	44"	16 lb	1.1 ft			GKM 4412	?	\$225	
	72" wide	50"	18 lb	1.3 ft			GKM 5012	?	\$228	
 <p>"D" Peninsulas</p> <p>Modesty is 17.5" narrower than work surface width.</p>	60" wide	40.5"	14 lb	1.0 ft	Full Height Modesty not available		GKM 4012	?	\$217	
	66" wide	46.5"	16 lb	1.1 ft			GKM 4612	?	\$225	
	72" wide	52.5"	18 lb	1.3 ft			GKM 5212	?	\$228	
 <p>Corners</p> <p>Modesty is 10" narrower than work surface width.</p>	36" wide	26"	18 lb	1.4 ft	GKM 2627	?	\$276	GKM 2612	?	\$193
	42" wide	32"	22 lb	1.6 ft	GKM 3227	?	\$296	GKM 3212	?	\$210
	48" wide	38"	26 lb	1.8 ft	GKM 3827	?	\$331	GKM 3812	?	\$217
 <p>Extended Corners</p> <p>Modesty is 10" narrower than work surface width.</p>	48" wide	38"	13 lb	0.9 ft	GKM 3827	?	\$331	GKM 3812	?	\$217
	60" wide	50"	17 lb	1.2 ft	GKM 5027	?	\$376	GKM 5012	?	\$228
	72" wide	62"	22 lb	1.5 ft	GKM 6227	?	\$421	GKM 6212	?	\$252
 <p>Bridges</p> <p>Modesty is 1" longer than work surface width.</p>	24" wide	25"	9 lb	0.6 ft	GKM 2527	?	\$274	GKM 2512	?	\$193
	30" wide	31"	11 lb	0.8 ft	GKM 3127	?	\$296	GKM 3112	?	\$199
	36" wide	37"	13 lb	0.9 ft	GKM 3727	?	\$318	GKM 3712	?	\$210
	42" wide	43"	15 lb	1.1 ft	GKM 4327	?	\$348	GKM 4312	?	\$217
	48" wide	49"	16 lb	1.1 ft	GKM 4927	?	\$370	GKM 4912	?	\$228
	54" wide	55"	17 lb	1.2 ft	GKM 5527	?	\$391	GKM 5512	?	\$241
	60" wide	61"	21 lb	1.5 ft	GKM 6127	?	\$415	GKM 6112	?	\$252
	66" wide	67"	23.5 lb	1.7 ft	GKM 6727	?	\$440	GKM 6712	?	\$258
 <p>3/4 Pedestal Desks</p> <p>Modesty panels are all 20" high, and 4" narrower than the work surface width.</p>	60" wide	56"	One height only, to match hanging pedestal height: 19-3/8"				GKM 5620	?	\$402	
	66" wide	62"					GKM 6220	?	\$421	
	72" wide	68"					GKM 6820	?	\$445	

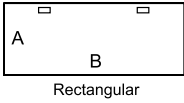

Work Surface Shape	A	B	C	D	Pkg Wt	Pkg Cube	Part #	Lam/Edge #	Price
Rectangular	23.5	48.0	(ped tower work surface)		39.5 lb	0.8 ft	WS 2348	?	\$684
	23.5	60.0	(ped tower work surface)		49.4 lb	1.0 ft	WS 2360	?	\$801
	24.0	24.0			20.2 lb	0.4 ft	WS 2424 G	?	\$560
	24.0	30.0			25.2 lb	0.5 ft	WS 2430 G	?	\$567
	24.0	36.0			30.2 lb	0.6 ft	WS 2436 G	?	\$611
	24.0	42.0			35.3 lb	0.7 ft	WS 2442 G	?	\$692
	24.0	48.0			40.3 lb	0.8 ft	WS 2448 G	?	\$699
	24.0	54.0			45.4 lb	0.9 ft	WS 2454 G	?	\$779
	24.0	60.0			50.4 lb	1.0 ft	WS 2460 G	?	\$788
	24.0	66.0			55.4 lb	1.2 ft	WS 2466 LR	?	\$836
	24.0	72.0			60.5 lb	1.3 ft	WS 2472 LR	?	\$893
	30.0	30.0			31.5 lb	0.7 ft	WS 3030 G	?	\$623
	30.0	36.0			37.8 lb	0.8 ft	WS 3036 G	?	\$677
	30.0	42.0			44.1 lb	0.9 ft	WS 3042 G	?	\$775
	30.0	48.0			50.4 lb	1.0 ft	WS 3048 G	?	\$783
	30.0	54.0			56.7 lb	1.2 ft	WS 3054 G	?	\$882
	30.0	60.0			63 lb	1.3 ft	WS 3060 G	?	\$889
	30.0	66.0			69.3 lb	1.4 ft	WS 3066 LR	?	\$947
30.0	72.0			75.6 lb	1.5 ft	WS 3072 LR	?	\$983	
36.0	48.0			60.5 lb	1.3 ft	WS 3648 G	?	\$980	
36.0	60.0			67.3 lb	1.5 ft	WS 3660 G	?	\$1,059	
36.0	66.0			83.2 lb	1.7 ft	WS 3666 LR	?	\$1,076	
36.0	72.0			90.7 lb	1.9 ft	WS 3672 LR	?	\$1,104	
Bow Rectangular	30.0	72.0	36.0		90.7 lb	1.9 ft	WSB 3672 LR	?	\$1,334
Curved Corner	24.0	36.0			30.2 lb	0.6 ft	WRCR 3636	?	\$833
	24.0	42.0			35.3 lb	0.7 ft	WRCR 4242	?	\$1,109
	24.0	48.0			40.3 lb	0.8 ft	WRCR 4848	?	\$1,133
Straight Corner	24.0	36.0			30.2 lb	0.6 ft	WCR 3636	?	\$837
	24.0	42.0			35.3 lb	0.7 ft	WCR 4242	?	\$1,111
	24.0	48.0			40.3 lb	0.8 ft	WCR 4848	?	\$1,131
Extended Corner Left	24.0	48.0	60.0	24.0	76 lb	2.1 ft	EC 23602 L	?	\$1,681
	24.0	48.0	72.0	24.0	86 lb	2.5 ft	EC 23722 L	?	\$1,909
	24.0	48.0	60.0	30.0	83 lb	2.1 ft	EC 23603 L	?	\$1,681
	24.0	48.0	72.0	30.0	96 lb	2.5 ft	EC 23723 L	?	\$1,909
	30.0	48.0	60.0	24.0	81 lb	2.1 ft	EC 33602 L	?	\$1,681
	30.0	48.0	72.0	24.0	87 lb	2.1 ft	EC 33722 L	?	\$1,909
	30.0	48.0	60.0	30.0	91 lb	2.5 ft	EC 33603 L	?	\$1,681
	30.0	48.0	72.0	30.0	100 lb	2.5 ft	EC 33723 L	?	\$1,909
Extended Corner Right	24.0	48.0	60.0	24.0	76 lb	2.1 ft	EC 23602 R	?	\$1,681
	24.0	48.0	72.0	24.0	86 lb	2.5 ft	EC 23722 R	?	\$1,909
	24.0	48.0	60.0	30.0	83 lb	2.1 ft	EC 23603 R	?	\$1,681
	24.0	48.0	72.0	30.0	96 lb	2.5 ft	EC 23723 R	?	\$1,909
	30.0	48.0	60.0	24.0	81 lb	2.1 ft	EC 33602 R	?	\$1,681
	30.0	48.0	72.0	24.0	87 lb	2.1 ft	EC 33722 R	?	\$1,909
	30.0	48.0	60.0	30.0	91 lb	2.5 ft	EC 33603 R	?	\$1,681
	30.0	48.0	72.0	30.0	100 lb	2.5 ft	EC 33723 R	?	\$1,909
"D" Shaped Peninsula	23.5	48.0			39.5 lb	0.8 ft	WP 2348 LR	?	\$863
	23.5	60.0			49.4 lb	1.0 ft	WP 2360 LR	?	\$975
	30.0	60.0			63 lb	1.3 ft	WP 3060 LR	?	\$1,127
	30.0	66.0			69.3 lb	1.4 ft	WP 3066 LR	?	\$1,244
	30.0	72.0			75.6 lb	1.6 ft	WP 3072 LR	?	\$1,260
"P" Shaped Peninsula Left	30.0	60.0	36.0		73.5 lb	1.6 ft	WPL 3060 LR	?	\$1,533
	30.0	66.0	36.0		79 lb	1.7 ft	WPL 3066 LR	?	\$1,707
	30.0	72.0	36.0		85 lb	1.9 ft	WPL 3072 LR	?	\$1,725
"P" Shaped Peninsula Right	30.0	60.0	36.0		73.5 lb	1.6 ft	WPR 3060 LR	?	\$1,533
	30.0	66.0	36.0		79 lb	1.7 ft	WPR 3066 LR	?	\$1,707
	30.0	72.0	36.0		85 lb	1.9 ft	WPR 3072 LR	?	\$1,725

Note:
Rectangular tops and transitional returns include one center grommet when 60" or less, and two grommets when 66" or more in width.

Grommets are positioned 18.5" from either side and 2" from the back of the work surface to avoid interference with pedestals.

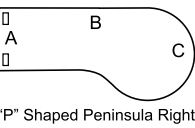
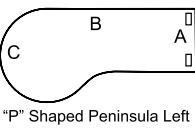
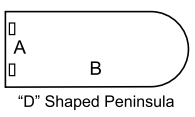
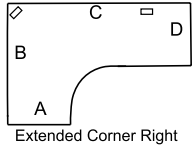
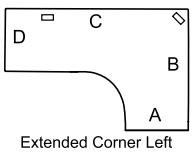
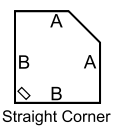
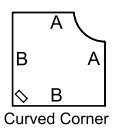
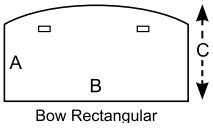

**Work Surface
Stiffeners**

Work surfaces that span 60" or more unsupported by legs or a work surface supporting pedestal should include a metal stiffener to prevent sagging. Stiffeners are factory-installed, in-set into the work surface so that there is no interference with pedestals or personal drawers that may be installed underneath

A	B	Pkg Wt	Pkg Cube	Part #	Price
24.0	60.0	50.4 lb	1.0 ft	WS 2460-ST	\$872
24.0	66.0	55.4 lb	1.2 ft	WS 2466-ST	\$950
24.0	72.0	60.5 lb	1.3 ft	WS 2472-ST	\$998
30.0	60.0	63.0 lb	1.3 ft	WS 3060-ST	\$975
30.0	66.0	69.3 lb	1.4 ft	WS 3066-ST	\$1,069
30.0	72.0	75.6 lb	1.5 ft	WS 3072-ST	\$1,117

KD Desk Hutch

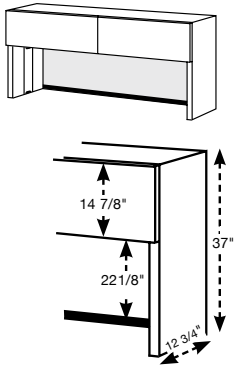

- Doors flip up to stow over the top, hutch compartment includes a vertical center divider
- 36" and 42" wide hutches include one door, all others include two doors
- Inside depth is 12-1/2" and inside height is 12-1/4"
- Out-of-sight locks are located beneath shelf, and the two doors are keyed alike
- Includes UM series locks - also available in LL. SL locks are not available
- Includes tack board and rubber wire management strip
- Bottom shelf accommodates a task light (sold separately)
- To add a loop pull (S: Satin Nickel Loop) to hutch doors, add an "L" as a suffix to the product number (no up-charge)
- Removable metal wire management covers on hutch side panels conceal task light cord
- Hutch upright side panels must be placed within 2" of a pedestal, panel leg, or corner leg to ensure adequate support
- Hutch width is actually 1" narrower than listed, to allow for 1/2" setback on both sides
- Hutch ships knocked down with assembly instructions for field installation
- Specify metal color and fabric
- For yardage requirements see "Ordering COM Fabrics" in this price book

H	D	W	Pkg Wt	Pkg Cube	Part #	Metal Color	Fabric #	GR 1 Price	GR 2 Price	GR 3 Price	GR 4 Price	GR 5 Price	COM Price
37	13-5/8	36	60 lb	13.3 ft	HGC 3602	?	?	\$3,058	\$3,216	\$3,330	\$3,446	\$3,540	\$3,053
37	13-5/8	42	66 lb	15.4 ft	HGC 4202	?	?	\$3,279	\$3,283	\$3,397	\$3,512	\$3,607	\$3,274
37	13-5/8	48	75 lb	17.5 ft	HGC 4802	?	?	\$3,348	\$3,349	\$3,463	\$3,578	\$3,670	\$3,343
37	13-5/8	54	81 lb	19.6 ft	HGC 5402	?	?	\$3,428	\$3,515	\$3,669	\$3,822	\$3,946	\$3,423
37	13-5/8	60	87 lb	21.7 ft	HGC 6002	?	?	\$3,502	\$3,579	\$3,735	\$3,886	\$4,012	\$3,497
37	13-5/8	66	93 lb	23.8 ft	HGC 6602	?	?	\$3,570	\$3,643	\$3,798	\$3,950	\$4,077	\$3,565
37	13-5/8	72	99 lb	25.9 ft	HGC 7202	?	?	\$3,671	\$3,836	\$4,026	\$4,217	\$4,374	\$3,666

**LED Linear
Task Light**

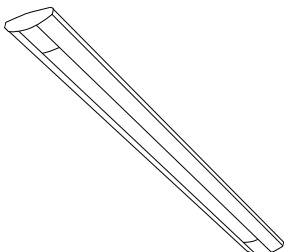

- 9' black power cord
- 3500K color temperature
- Metal trough reflector with diffuser lens
- Magnetic or screw mounting options
- Clear anodized aluminum with flint color end caps, UL/CUL listed
- 5 year warranty

LED Green Advantages:

- Solid state technology eliminates the need for Chicago Code (fused plugs)
- Low energy consumption, No UV emissions, no flickering
- No disposal hazards - no mercury, lead, or gases
- Long life @ 50,000 hours eliminating re-lamp and maintenance time
- Allows for low profile, light weight, fixture designs

For Use on	H	D	W	LEDs	Pkg Wt	Pkg Cube	Part #	Price
24" to 36" shelves	1/2	2	16-1/2	24	4 lb	2 ft	LD 618	\$645
42" to 72" shelves	1/2	2	30-1/8	48	10 lb	3 ft	LD 1236	\$1,039

Personal Drawer

- Sleek, metal design allows the drawer to hide discretely beneath the desk
- Full extension steel ball-bearing slides
- Four integral storage compartments
- Mounts to underside of work surface using "L" brackets affixed to drawer slides
- Drawer and mounting brackets are 22 gauge steel
- Charcoal powder coat finish
- Available with or without a lock
- Lock may also be ordered separately for field installation, and add 1-1/2" width to the drawer size

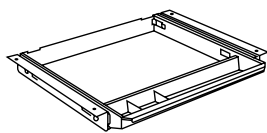

Description	H	D	W	Pkg Wt	Pkg Cube	Part #	Price
drawer with lock	2-1/8	17-1/4	21-3/4	13 lb	1 ft	NFC7657889-UM	\$442
drawer only	2-1/8	17-1/4	21-3/4	13 lb	1 ft	NFC7657889	\$311
lock only	2-1/8	1-1/2	1-1/2	1 lb	.5 ft	NFCX00020	\$131

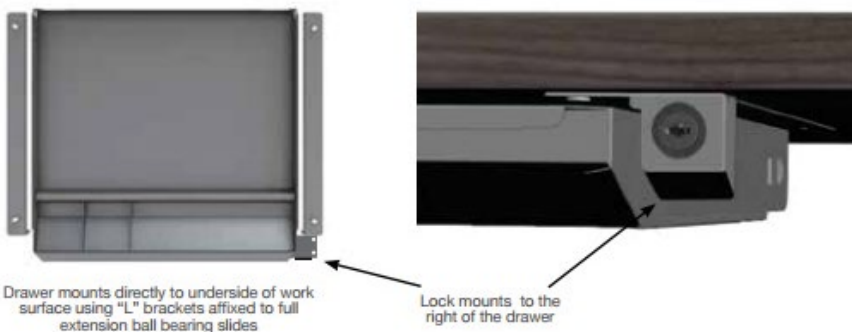

**Acrylic
Privacy Screens**

- Frosted acrylic screens are 1/4" thick
- Screens 54" and smaller include two aluminum brackets
- Screens 60" and wider include three aluminum brackets
- These brackets may be paired with modesty panel brackets shown below
- Top of Acrylic privacy screen to floor measures 41-1/2"

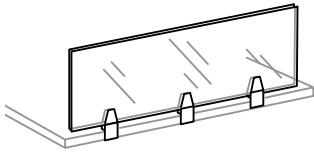

H	W	Description	Pkg Wt	Pkg Cube	Part #	Price
12-1/2	23	24" acrylic privacy screen	3.5 lb	0.7 ft	ACR 1124 F	\$299
12-1/2	29	30" acrylic privacy screen	4.25 lb	0.9 ft	ACR 1130 F	\$345
12-1/2	35	36" acrylic privacy screen	5.0 lb	1.08 ft	ACR 1136 F	\$380
12-1/2	41	42" acrylic privacy screen	5.75 lb	1.26 ft	ACR 1142 F	\$406
12-1/2	47	48" acrylic privacy screen	6.25 lb	1.44 ft	ACR 1148 F	\$437
12-1/2	53	54" acrylic privacy screen	7.0 lb	1.63 ft	ACR 1154 F	\$674
12-1/2	59	60" acrylic privacy screen	7.75 lb	1.81 ft	ACR 1160 F	\$712
12-1/2	65	66" acrylic privacy screen	8.75 lb	1.99 ft	ACR 1166 F	\$720
12-1/2	71	72" acrylic privacy screen	9.59 lb	2.17 ft	ACR 1172 F	\$723

**Acrylic
Modesty Panels**

- Frosted acrylic screens are 1/4" thick
- Panel widths are designed to be 1" narrower than the work surface (1/2" inset on each side)
- Screens 54" and smaller include two aluminum brackets
- Screens 60" and wider include three aluminum brackets
- These brackets may be paired with privacy screen brackets shown above

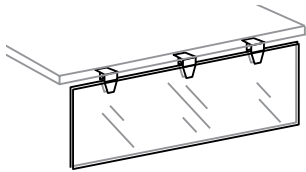

H	W	Description	Pkg Wt	Pkg Cube	Part #	Price
12-1/2	29	30" acrylic modesty panel	4.25 lb	0.9 ft	ACR 1130	\$338
12-1/2	35	36" acrylic modesty panel	5.0 lb	1.08 ft	ACR 1136	\$374
12-1/2	41	42" acrylic modesty panel	5.75 lb	1.26 ft	ACR 1142	\$400
12-1/2	47	48" acrylic modesty panel	6.25 LB	1.44 ft	ACR 1148	\$432
12-1/2	53	54" acrylic modesty panel	7.0 lb	1.63 ft	ACR 1154	\$665
12-1/2	59	60" acrylic modesty panel	7.75 lb	1.81 ft	ACR 1160	\$705
12-1/2	65	66" acrylic modesty panel	8.75 lb	1.99 ft	ACR 1166	\$709
12-1/2	71	72" acrylic modesty panel	9.59 lb	2.17 ft	ACR 1172	\$713

**Brackets Sold
Separately**

Our brushed aluminum clips are also sold separately to be used with customer-supplied privacy screen or modesty panel material. (1/4" thickness required for modesty panel and 1-1/4" thickness for worksurface.

Description	Part #	Price
Two complete clip assemblies to support both above-surface screen and below-surface modesty panel. Includes mounting hardware and instruction sheets	ACM 02K	\$231
Three complete clip assemblies to support both above-surface privacy screen and below-surface modesty panel. Includes mounting hardware and instruction sheets	ACM 03K	\$313

Bracket Detail:

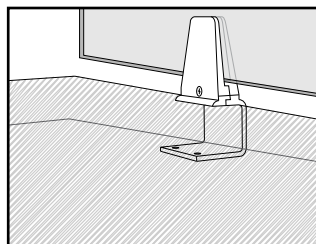

Privacy Screen Bracket
Attaches underneath work surface
with fasteners (included)

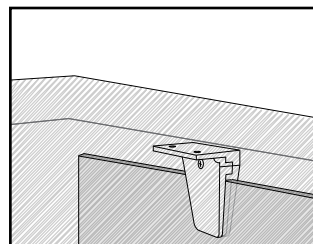

Modesty Panel Bracket
Attaches underneath work surface
with fasteners (included)

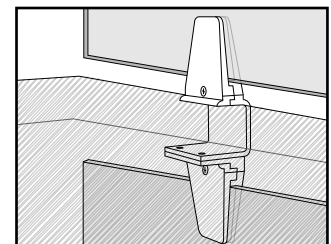

Privacy Screen and Modesty Panel
brackets may be used together

**Metal
Modesty Panels
- Solid**

- These metal modesty panels are solid; they do not include perforations
- Wire management tray at bottom is 2" deep
- Panels are 20 gauge
- Panels attach underneath the work surface with 3/4" fasteners (included)
- Panels are designed to be in-set 6" from each side of the work surface

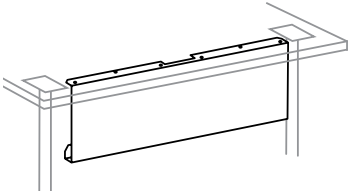

H	D	W	Description	Pkg Wt	Pkg Cube	Part #	Metal Color	Price
11	2	18	18" panel for 30" WS	3.25 lb	0.38 ft	MOD 1811	?	\$257
11	2	24	24" panel for 36" WS	4.25 lb	0.50 ft	MOD 2411	?	\$272
11	2	30	30" panel for 42" WS	5.25 lb	0.61 ft	MOD 3011	?	\$288
11	2	36	36" panel for 48" WS	6.25 lb	0.73 ft	MOD 3611	?	\$302
11	2	42	42" panel for 54" WS	6.75 lb	0.84 ft	MOD 4211	?	\$318
11	2	48	48" panel for 60" WS	8.12 lb	0.95 ft	MOD 4811	?	\$335
11	2	54	54" panel for 66" WS	9.25 lb	1.07 ft	MOD 5411	?	\$353
11	2	60	60" panel for 72" WS	9.75 lb	1.18 ft	MOD 6011	?	\$370

**Metal
Modesty Panels
- Perforated**

- Perforated metal modesty panel
- Perforations are 1/2" in diameter
- Wire management tray at bottom is 2" deep
- Panels are 20 gauge
- Panels attach underneath the work surface with 3/4" fasteners (included)
- Panels are designed to be in-set 6" from each side of the work surface

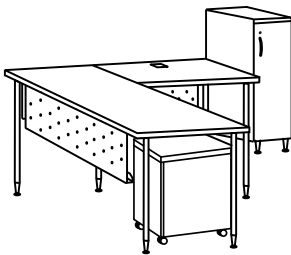
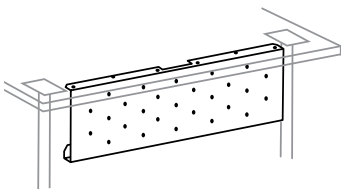

H	D	W	Description	Pkg Wt	Pkg Cube	Part #	Metal Color	Price
11	2	18	18" panel for 30" WS	3.25 lb	0.38 ft	MOD 1811 P	?	\$272
11	2	24	24" panel for 36" WS	4.25 lb	0.50 ft	MOD 2411 P	?	\$288
11	2	30	30" panel for 42" WS	5.25 lb	0.61 ft	MOD 3011 P	?	\$302
11	2	36	36" panel for 48" WS	6.25 lb	0.73 ft	MOD 3611 P	?	\$318
11	2	42	42" panel for 54" WS	6.75 lb	0.84 ft	MOD 4211 P	?	\$335
11	2	48	48" panel for 60" WS	8.12 lb	0.95 ft	MOD 4811 P	?	\$353
11	2	54	54" panel for 66" WS	9.25 lb	1.07 ft	MOD 5411 P	?	\$370
11	2	60	60" panel for 72" WS	9.75 lb	1.18 ft	MOD 6011 P	?	\$384

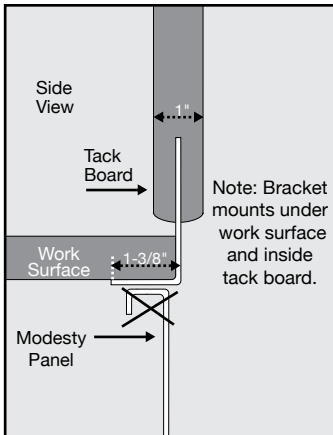

Cannot be used with modesty panels.

- Tackable board is covered on both sides with fabric of your choice. Brackets and fasteners are included, which allow the screen to be fastened to the underside of the work surface
- 12 gauge metal mounting brackets slide between these back-to-back tackable boards and are hidden from sight (See cut-away diagram below)
- Please note that tackable privacy screens may not be added to a desk when modesty panels are in use because the screen mounting brackets interfere with the modesty panel location
- Screens 35" and narrower include two mounting brackets
- Screens 41" and wider include three mounting brackets
- Privacy screen widths may be matched to that of the corresponding work surface size
- Screens measure one inch less than the work surface widths to allow for even spacing between screens, wire management, and cornering applications
- For yardage requirements see "Ordering COM Fabrics" in this price book on page 10

**Tackable Screen
– Rectangular**

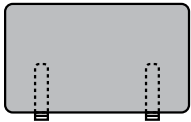

Dotted lines indicate hidden mounting brackets

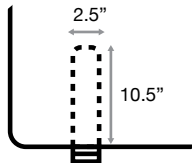

H	D	W	Pkg Wt	Pkg Cube	Part #	Fabric #	GR 1 Price	GR 2 Price	GR 3 Price	GR 4 Price	GR 5 Price	COM Price
20-3/4	1	23	9 lb	.6 ft	PSR 24	?	\$685	\$861	\$932	\$1,004	\$1,063	\$680
20-3/4	1	29	10 lb	.8 ft	PSR 30	?	\$770	\$947	\$1,018	\$1,090	\$1,144	\$765
20-3/4	1	35	11 lb	.9 ft	PSR 36	?	\$850	\$1,112	\$1,217	\$1,325	\$1,409	\$845
20-3/4	1	41	13 lb	1.0 ft	PSR 42	?	\$924	\$1,188	\$1,293	\$1,398	\$1,485	\$919
20-3/4	1	47	14 lb	1.2 ft	PSR 48	?	\$976	\$1,239	\$1,345	\$1,452	\$1,539	\$971
20-3/4	1	59	17 lb	1.5 ft	PSR 60	?	\$1,215	\$1,657	\$1,834	\$2,010	\$2,153	\$1,210
20-3/4	1	65	18 lb	1.6 ft	PSR 66	?	\$1,280	\$1,721	\$1,896	\$2,073	\$2,218	\$1,275
20-3/4	1	71	19 lb	1.8 ft	PSR 72	?	\$1,394	\$1,836	\$2,013	\$2,189	\$2,331	\$1,389

H	D	W	Pkg Wt	Pkg Cube	Part #	Fabric #	GR 1 Price	GR 2 Price	GR 3 Price	GR 4 Price	GR 5 Price	COM Price
11	1	23	7 lb	.6 ft	SPR 24	?	\$602	\$776	\$848	\$916	\$976	\$597
11	1	29	8 lb	.8 ft	SPR 30	?	\$657	\$832	\$904	\$975	\$1,032	\$652
11	1	35	9 lb	.9 ft	SPR 36	?	\$721	\$985	\$1,091	\$1,197	\$1,283	\$716
11	1	41	11 lb	1.0 ft	SPR 42	?	\$785	\$1,050	\$1,157	\$1,262	\$1,346	\$780
11	1	47	12 lb	1.2 ft	SPR 48	?	\$829	\$1,093	\$1,200	\$1,306	\$1,391	\$824
11	1	59	14 lb	1.5 ft	SPR 60	?	\$1,034	\$1,477	\$1,650	\$1,826	\$1,970	\$1,029
11	1	65	16 lb	1.6 ft	SPR 66	?	\$1,086	\$1,529	\$1,704	\$1,880	\$2,022	\$1,081
11	1	71	19 lb	1.8 ft	SPR 72	?	\$1,183	\$1,623	\$1,800	\$1,978	\$2,121	\$1,178

**Tackable Screen
– Scalloped**

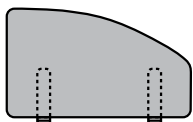

Hidden mounting brackets

- Scalloped-shaped screen provides a "finished" look for desks positioned at the end of a run
- Available for use with 20-3/4" high rectangular screens only
- See page 10 for yardage requirements

H	D	W	Pkg Wt	Pkg Cube	Part #	Fabric #	GR 1 Price	GR 2 Price	GR 3 Price	GR 4 Price	GR 5 Price	COM Price
20-3/4	1	29	10 lb	.8 ft	SPSR 30	?	\$843	\$1,019	\$1,091	\$1,162	\$1,217	\$838
20-3/4	1	35	11 lb	.8 ft	SPSR 36	?	\$912	\$1,177	\$1,283	\$1,388	\$1,476	\$907

**Work Surface
Splice Plate**

- Connect two work surfaces at 90 degree angles to one another.
- Plate dimensions: 4" x 4"

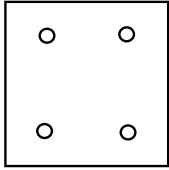

Description	Qty	Pkg Wt	Pkg Cube	Part #	Price
splice plates (black)	pkg. of 2 plates	1.1 lb	.01 ft	GSP 02 K	\$66

**Work Surface
Grommet
Field Installed**

- Package of ten 2-1/2" diameter round black plastic grommets for field installation
- Circular shape allows for easy installation at the work site

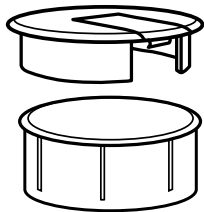

Description	Pkg Wt	Pkg Cube	Part #	Price
(10) round grommets	4 lb	.6 ft	GRM 0010	\$130

**Plastic Wire
Management
Channel**

- Black plastic wire organizer channels hide tangled wires and cables. Self-adhesive backing mounts horizontally or vertically on modesty panels, end panel legs, pedestals or underside of work surfaces
- Kit includes 4 channels that are 18" long x 2-1/2" wide x 1-1/4" tall. Channels may be cut to desired length

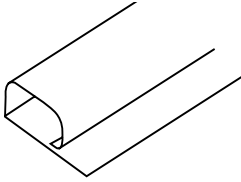

Description	Pkg Wt	Pkg Cube	Part #	Price
(4) 18" channels	6 lb	3 ft	WMG 4018	\$81

Cupcake

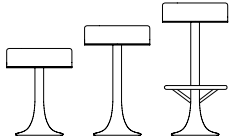

FABRIC

COM	Customer Supplied
GR1	Grade 1
GR2	Grade 2
GR3	Grade 3
GR4	Grade 4
GR5	Grade 5

- The seat frame is constructed of one horizontal panel fabricated from upholstery grade, 15/16" thick, 7-ply fir plywood.
- Cushion top panel is 3 inch thick, fire retardant polyurethane foam of 2.8 lb density and 80 lb IFD. The vertical outside surfaces are 1/4" thick, fire retardant polyurethane foam of 1.6 lb density and 55 lb IFD at 25% deflection
- Meets California Technical Bulletin 117 for flammability. Class A fire rated in accordance with Commercial Standard CS-191-53.
- Fully upholstered unit is in accordance with BIFMA F-1-1978 (Rev. A80), First Generation Voluntary Upholstered Furniture Flammability Standard for Business and Institution Markets
- Trumpet stool base is 16 gauge spun steel with a powder coat finish. Weldment consists of a vented top plate and a spun steel weighted base. The stool base is attached to the cushion assembly by means of a 1/4-20 satin nickel, decorative head machine screw and a 1/4-20 nonvisible propeller nut. The underside of the base is Teflon coated to produce a non-abrasive, easy-slide surface
- Yardage Requirements: 1 yard, based on 54" wide plain fabric. Please contact customer service for fabrics with repeats or different widths to determine yardage requirements

H	Diameter	Part #	Metal #	Fabric #	GR 1 Price	GR 2 Price	GR 3 Price	GR 4 Price	GR 5 Price	GR 6 Price	COM Price
19	15	CUPCAKE-SIDE	?	?	\$2,036	\$2,114	\$2,153	\$2,233	\$2,310	\$2,391	\$2,031
24	15	CUPCAKE-CTR	?	?	\$2,274	\$2,354	\$2,392	\$2,472	\$2,550	\$2,629	\$2,269
29	15	CUPCAKE-BAR	?	?	\$2,779	\$2,857	\$2,896	\$2,977	\$3,054	\$3,132	\$2,774

Oscar

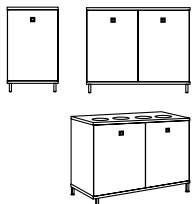

- Choose laminate color and size of your recycling job with the two or four bin unit. Matte nickel steel legs and drawer pulls come standard on every Oscar
- Stainless steel flush mounted inserts
- Matte nickel steel legs and door pulls
- 1-3/8" diameter black nylon leveling glides with a stainless steel stem
- Trim is 11 gauge steel fastened proud to underside of the case
- Oscar-2 includes two 23 gallon Slim Jims, Oscar-4 includes four 23 gallon Slim Jims
- Laminate available in Frosty White, Slate Grey and Black

H	D	W	Part #	Price
39.9	24	24	OSCAR-2	\$5,011
39.9	24	48	OSCAR-4	\$7,318

COMMERCIAL TERMS & CONDITIONS

These conditions of sale supersede all previous selling policies. Prices, discounts, lead-times and product offerings are subject to change without notice.

Order Placement

Great Openings requires that all orders be submitted in writing to avoid errors and/or duplication. Sales of all Great Openings' products are made only on the Company's standard terms and conditions of sale, unless modified in writing by an authorized Great Openings representative.

Orders received at Great Openings after 4:00pm EST will be processed the following day.

Order Acknowledgement

We diligently issue order acknowledgements via e-mail within 24 hours of purchase order receipt. If you do not receive an acknowledgement within 24 hours, please call our Customer Service department to determine the reason; we may not have received your order, or we may have questions that are delaying order entry.

**PLEASE CHECK
ACKNOWLEDGEMENTS
FOR ERRORS
IMMEDIATELY UPON RECEIPT.**

The order acknowledgement process is designed to ensure protection for both the buyer and the seller. We strongly urge the buyer to make sure the acknowledgement accurately reflects the intended purchase.

Order Discrepancies

Great Openings will not be held responsible for extra costs due to errors resulting from purchase order inaccuracies. If and when a discrepancy is detected on the purchase order or acknowledgement, all corrections must be received in writing before further order processing can occur.

Changes, Cancellations

Orders may not be changed, corrected or cancelled, in whole or in part, after Great Openings has issued its order acknowledgement without the written consent of an authorized Great Openings representative. Special order items (special or custom cabinets, Customer's Own Materials (COM) fabric and laminates) already in production are not subject to change or cancellation under any circumstances.

Canadian Orders

Canadian orders may be processed using this price book. The pricing and payment terms included in this book are in U.S. funds. Custom brokerage fees and GST/HST taxes will be charged as separate line items on the invoice. All prices are freight included; FOB: Destination. A Regional Small Order Freight Charge applies to all orders less than \$5,000 list (does not apply to accessory orders). See regional map for applicable fee.

Lead-Time

Lead-times are measured in working days, and begin after receipt of clean order.

Lead-times may change without notice. Stated lead-times will not commence until purchase order is actually entered into our system. We are not responsible for delays caused by order discrepancies or late receipt of COM items.

Special Shipping Instructions

Great Openings will accommodate special shipping/delivery requests whenever possible. Purchaser will be responsible for any and all extra costs incurred by reason of Great Openings complying with a special shipping request. Examples of special requests that may cause extra charges (dollar amounts shown are approximate, actual amounts may vary):

- special carrier/lift gate: starting at \$85.00
- inside delivery: starting at \$50.00
- expediting, re-consignment, delays causing carrier storage: starting at \$50.00
- truck load delivery times after 3:00 pm, Monday through Thursday start at \$400
- truck load delivery after 3:00 pm, on Friday: \$800
- delivery times outside normal business hours including weekends and holidays: starting at \$450.00 per truck
- exact, narrow scheduling window (elevator time): starting at \$150.00
- non-commercial/residential deliveries: starting at \$60.00

The maximum amount of time allowed for off-loading product from trailers is 3 hours. Carrier costs associated with any additional delivery time will be charged to the dealer. Any additional charges that result from the purchaser failing to accept a shipment as agreed upon will be the responsibility of the purchaser.

Special Delivery Charges

Once a delivery truck arrives at a destination, if the recipient is not ready to accept delivery as scheduled and the truck must wait, deliver "after hours", or make a second drop at a later time, the carrier charges a penalty for that delay which Great Openings must pass on to the customer.

These charges are as follows (dollar amounts shown are approximate, actual amounts may vary):

- Night Delivery:
- 3:30-4:30 p.m.: \$400 additional charge
 - 4:30-5:30 p.m.: \$450 additional charge
 - 5:30 p.m. and later: \$500 additional charge
- Detention fee will be \$75 per hour after two hours. Drop charge will be \$75 per drop.

Weekend and holiday deliveries will be quoted per load depending on location and delivery time.

Please use caution when planning and communicating delivery requirements so that these exorbitant fees will not be necessary.

Key-Alike Services

Key-alike service is offered free of charge provided the key-alike request is associated with an order for a matching quantity of cabinets. Additional key/core sets, master and core keys are available for a nominal charge. All Great Openings products are keyed randomly prior to shipment. Special cores and keys are shipped separately to be changed-out in the field. See the Specification Guide in the front of this book.

COM & Fabric Grades

If COM materials are difficult to apply or inadequate, Great Openings reserves the right to apply extra charges or to cancel the order. Great Openings has no control over COM material quality or performance and will not be held responsible for material defects or damage caused by improper use or application.

Limited Lifetime Warranty

Great Openings warrants its Great Openings brand Metal Case-goods, Trace and Cayenne Desks, Files, Storage, Lockers and Sparkeology products to be free from defects in materials and workmanship for the life of the product, except as set forth below. This warranty applies to Great Openings products delivered in the United States and Canada and is non-transferable. The warranty is valid from the date of delivery to the End User. This warranty does not cover ordinary wear and tear, improper installation, outdoor use, or direct mis-use of the product. This warranty does not apply to Customer's Own Materials (COM) for fabric, laminates, or edge bands. In addition, supplier warranties will apply to products not manufactured by Great Openings. End User means the final purchaser acquiring a product from Great Openings or the Great Openings Dealer channel for the purchaser's own use and not for resale, remarketing or distribution. Great Openings will not be liable for loss of time, inconvenience, commercial loss, incidental or consequential damages.

EXCEPTIONS TO THE LIFETIME COVERAGE

Laminate Lockers – 12 years

Single, Double, Multi-purpose, Quad, and Cubby Laminate Lockers and includes both TFL and HPL options.

Tables – 5 years

Sparkeology Line Products: Pete and Oscar

Seating and Tables – 2 years

Height Adjustable Tables, Sparkeology Line Products: Ben, Manny, Sly, Sophia, Cupcake, and Lily

High Wear Parts – 1 year

Mobile Storage Casters, Gas Rods, Cushion Pads, Hinges, Power and Electrical components

Surfaces Materials Disclaimer:

- Exact matching of surface finishes, including an exact match to cuttings, samples, or swatch cards are not covered.
- Changes in surface finishes and colorfastness due to aging, exposure to artificial light or exposure to direct sunlight are not covered.

Credit Card Transaction Fee

Credit card payments in excess of the following thresholds will be subject to a 2.16% transaction fee. Please note that Great Openings also accepts payments via ACH, wire transfer, and check – all free of charge.

Type of Sale	Credit Card Threshold (per sales order)	Fee Assessed for Amount Over this Threshold
Commercial	\$10,000.00	2.16%
GSA: Project in USA	\$20,000.00	2.16%
GSA: Project outside of USA	\$30,000.00	2.16%

COMMERCIAL TERMS & CONDITIONS

Regional Pricing

Great Openings reserves the right to adopt regional discount programs and small order freight charges to address the freight cost impact applicable to each geographic region. A buyer's region will be determined by shipping destination.

Payment Terms

Orders are invoiced at the time of shipment and payment is due upon receipt of the invoice. Invoices unpaid thirty (30) days after the invoice date are subject to a late payment charge in the amount of one and one-half percent (1-1/2%) per month on the unpaid balance until paid. Great Openings reserves the right to modify or establish special credit arrangement for any customers at any time at its sole discretion. All prices are subject to change without notice.

Remit to:

GREAT OPENINGS
PO Box 7581
Carol Stream, IL 60197-7581

Taxes

All sales, use, excise and other applicable taxes (excluding only taxes on the net income of Great Openings) are the purchaser's responsibility and will be invoiced to the purchaser. If purchaser claims an exemption from such taxes, it shall be the purchaser's responsibility to furnish an appropriate exemption certificate to Great Openings.

For Canadian orders, Great Openings does invoice and collect for GST/HST.

Freight Policy

All prices are freight included, F.O.B. Destination. Prices are based on a single shipment to a single location. A Small Order Freight Charge applies to all orders less than \$7,500 list (does not apply to orders for accessories).

See the map below for Small Order Freight Charge by destination. Effective July 1, 2024, orders totaling less than \$7,500 list that are shipped to Michigan, Wisconsin, Illinois, Indiana, Ohio, Kentucky, and West Virginia a Small Order Freight Charge of \$100 net will apply. For orders totaling less than \$7,500 list that are shipped to the remainder of the continental U.S. and southern portions of Canada as shown on the map, a Small Order Freight Charge of \$200 net will apply. For Alaska, Hawaii, and all other portions of Canada, please call for a quote.

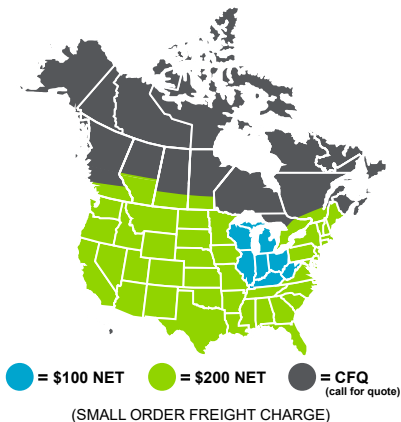

A flat rate \$15 FedEx shipping and handling fee will be charged at time of purchase order to handle incidental small product packages (i.e. keys, name plates, file bars, etc.).

Standard Packaging

All Great Openings' products are packaged in accordance with industry standards and common carrier requirements. Pedestal products are individually boxed with polystyrene corner guard inserts, then palletized, and shrink wrapped. Lateral and storage product packaging consists of corrugated top and bottom trays, corner guards, palletized, shrink wrapped and labeled. For full truckloads only, upon special requests, we can provide a blanket wrapped shipment; please call for a quote.

Shipment and Delivery

Freight is included in the prices as displayed in this price book. All shipments are FOB destination: free freight to destination in the continental United States. Shipments outside the contiguous 48 states will be freight collect from exit port. Exception for Canadian shipments; see the section on Canadian orders. Great Openings will select the mode and carrier of shipment.

- Partial shipments may be necessary and are at the discretion of Great Openings.
- Great Openings cannot guarantee exact time of delivery.
- Any charges resulting from late deliveries beyond our control are not the responsibility of Great Openings.
- Ship dates contained in order acknowledgements are estimated and not guaranteed.

Great Openings will often consolidate orders to maximize shipping efficiency. In these situations, a customer's designated ship date may change, though Great Openings will make every effort to ensure that requested delivery dates are still met.

Product Storage Fees

Once an order enters production, it is not possible to stop production on that order if a last-minute request is made to delay shipment. If it is absolutely necessary to hold the product at Great Openings for a later ship date, a holding fee of \$10 net per pallet will be assessed each week and partial week until the product ships. Weekly storage fees will be the responsibility of the purchaser on any delayed shipment of a produced order.

Returns

Great Openings will not accept returned goods.

Claim Policy

It is the purchaser's responsibility to examine goods upon receipt and to notify Great Openings customer service with any concerns. Any claims against Great Openings for apparent defects, errors or shortages must be made by the purchaser within five (5) working days after any delivery. Failure by the purchaser to make any claim against Great Openings within (5) days shall constitute acceptance of the goods and waiver of any apparent defects, errors or shortages.

Freight Damage Claims

Great Openings' terms are FOB destination. Great Openings is not responsible for damage that occurs in transit. All Great Openings' products are carefully inspected prior to shipment. The carrier signs for all goods received in apparent good order.

It is the buyer's responsibility to inspect goods upon receipt for both apparent and concealed damage. In the rare instance where shipping damage is found, we ask the purchaser NOT to refuse shipment. Accepting shipment will give us more opportunities to remedy the situation through parts (fronts, tops) replacement and within the guidelines of the stated terms.

Claim and Replacement Policy

In the case of documented shipping damage, Great Openings will file a claim with the carrier and issue at no charge any replacement parts or product only if the purchaser meets the following conditions:

- Product is shipped via a Great Openings designated carrier
- Accept the shipment
- Retain packaging
- Inspect the shipment and document damage on the bill of lading
- Contact Great Openings immediately upon discovery and documentation of damage

Failure of purchaser to meet these conditions will prevent Great Openings from obtaining carrier reimbursement and thereby require us to charge full price for product replacement.

Great Openings is not responsible for labor or trip costs associated with freight damage product replacement.

Concealed Damage Policy

Concealed damage (damage discovered after acceptance with no bill of lading documentation) should be reported to Great Openings immediately upon discovery. Please retain packaging and request carrier inspection immediately. Carrier liability ceases 7 calendar days after receipt of shipment. Great Openings will investigate on a case-by-case basis. In any case, Great Openings assumes no liability beyond the 7-day carrier liability and reserves the right to apply no remedy and/or various remedies dictated by individual event circumstances.

The buyer may make NO DEDUCTION UNDER ANY CIRCUMSTANCES ensuing from freight claims when settling invoices with Great Openings.

Service

Please contact Great Openings with any service concerns:

Great Openings
902 E. Fourth Street
Ludington, MI 49431
Ph: 888-712-8582

GSA TERMS & CONDITIONS

- Metal and Laminate filing, storage, freestanding desk products
- Contract Number: 47QSMS25D00BW
- Current Contract Period: September 4, 2025 - September 3, 2030
- Great Openings/Metalworks tax ID: 38-189 8020
- FSC Schedule MAS - Office Furniture
- Special Item Numbers (SIN) 33721
- Certified Small Business
- greatopenings.com

1a) Special Item Numbers Awarded:

SIN 33721 Office Furniture-
Includes all furniture placed in an office

1b) Lowest Priced Item:

SIN 33721 6" Drawer Divider ECOX1070- 1 (\$15.00 list)

1c) Hourly rates not applicable

2) Maximum Order:

SIN 33721 \$250,000.00 net

3) Minimum Order:

SIN 33721 \$50.00 net

4) Geographic Coverage:

All 48 contiguous states and the District of Columbia. Port of embarkation for delivery to Alaska, Hawaii, Puerto Rico, The Virgin Islands. U.S. Government installations overseas.

5) Point of Production:

Ludington, Michigan; Manistee, Michigan

6) Discount From List Prices

69.8%

7) Tier Discounts:

Tier discounts are available, call for details.

8) Prompt Payment Terms:

Net 30 Days

9a) Government Purchase Cards - Below Micro Threshold:

Visa and MasterCard accepted

9b) Government Purchase Cards - Above Micro Threshold:

Visa and MasterCard accepted

10) Foreign Items:

None (All products are manufactured, painted and assembled in U.S.)

11a) Time of Delivery:

Shipment: When applicable, within our standard lead-time, which is noted in the Commercial Terms and Conditions.
Delivery: 30 days after receipt of order.

11b) Expedited Delivery:

Considered on a case-by-case basis.
Call Great Openings for availability and cost.

11c) Overnight and Two-Day Delivery:

Considered on a case-by-case basis
Call Great Openings for availability and cost.

11d) Urgent Requirements:

Considered on a case-by-case basis.
Call Great Openings for availability and cost.

12) F.O.B. Destination, Freight Prepaid and Allowed:

48 Contiguous States and Washington D.C.

For GSA orders totaling less than \$1,000.00 net that are shipped to the states of Michigan, Wisconsin, Illinois, Indiana, Ohio, Kentucky, and West Virginia a Small Order Freight Charge of \$100.00 will apply. For orders totaling less than \$1,000.00 net that are shipped to the remainder of the Contiguous United States, including Washington D.C., a Small Order Freight Charge of \$200.00 will apply.

13a) Ordering Address:

Great Openings
902 E. Fourth Street
Ludington, Michigan 49431
Phone 888-712-8582
goorders@greatopenings.com

13b) Ordering Procedures:

For supplies and services, the ordering procedures, information on Blanket Purchase Agreements (BPA's), and a sample BPA can be found in Federal Acquisition Regular (FAR) 8.405-3.

14) Payment Address:

GREAT OPENINGS/METALWORKS INC
PO Box 7581
Carol Stream, IL 60197-7581

15) Warranty Provision:

Lifetime Warranty
See warranty section for complete details in the Commercial Terms and Conditions.

16) Export Packaging Charges:

Quoted upon request

17) Terms And Condition of Government Purchase Card:

See item 9a + 9b. No additional discounts given.

18) Terms and Conditions of Rental, Maintenance and repair:

Not Applicable

19) Terms and Conditions of Installation:

Contact dealer or installation representative.

20) Terms and Conditions of Repair Parts:

Not Applicable

20a) Terms and Conditions for Any Other Services:

Not applicable

21) List of Service and Distribution Points:

Not Applicable

22) List of Dealers:

Please contact Great Openings for your nearest Great Openings Dealer.

23) Preventative Maintenance:

Not offered

24a) Environmental Attributes:

Has an active environmental program. Please contact Great Openings Dealer.

24b) Section 508 Electronic Compliance:

Currently not available

25) DUNS Number:

1-495-0549

26) SAM:

Great Openings is registered with the System For Award Management database. Cage Code: 33LN6
SAM UEI: MCJEDHT14DC6

Cancellation Policy:

Orders may not be cancelled or changed without approval from Great Openings. If an order is cancelled prior to production, no cancellation charge will apply.

After production has begun, the Government will pay actual costs that the contractor can demonstrate if the product is not sold in a reasonable length of time (3 months).

Returns / Restocking Charge:

The Government will pay a 30% restocking charge.

The customer agency must obtain written authorization from Great Openings before returning any product. The customer agency will pay all return freight charges. Product returned in damaged condition will not be accepted.

DOD Requirements for Wood Packaging:

DOD's requirements (ISPM 15) for wood packaging material (WPM) are designed to block the movement of forest-destrating pests from one nation to another. Please clearly mark DOD-related purchase orders so that the required packaging can be included.



902 East 4th Street
Ludington, MI 49431
888-712-8582
greatopenings.com
goorders@greatopenings.com