



Education  
Products  
Price List



Prices Effective June 1, 2025

**Updates and revisions to this book:**

Date	Page	Update
5-8-25		Pricing Updates
1-12-26	5	Flexible Soft Seating Addition

# QUICK REFERENCE FOR ORDERING

## PAINT FINISHES

### Great Openings Standard Colors

<b>Allsteel</b>		<b>Haworth</b>	
0217	Brilliant White	0159	Beige
01A7	Champagne Metallic	02Z8	Cement Textured
0073	Cloud	0141	Chalk
0232	Driftwood	0006	Charcoal
0231	Flint	0547	Graphite
0536	Loft	0205	Greystone
0683	Muslin	02Z9	Grout Textured
0345	Parchment	0112	Putty
0166	Platinum Metallic	02Y9	Silver Metallic
0239	Fossil	0131	Smoke
<b>Herman Miller</b>		<b>Knoll</b>	
0256	Black Umber	0968	Beige Mist Metallic
0257	Light Grey	02Z2	Bright White Smooth
0004	Medium Tone	02Z3	Bright White Textured
0001	Dark Tone	02Y7	Brown
0744	Metallic Champagne	0623	Folkstone Grey
0666	Silver Metallic	0188	Medium Grey
02L6	Soft White	02Y6	Medium Metallic Grey
0784	Warm Grey Neutral	0756	Sandstone
0348	Innertone Light	02X9	Silver Metallic
		0030	Soft Grey
<b>Steelcase</b>		<b>Teknion</b>	
0995	Arctic White Textured	02M0	Arctic Textured
0668	Black Textured	02X5	Espresso Textured
0044	Black	02M3	Granite
0998	Carbon Metallic Textured	02A3	Grey
0678	Fieldstone Textured	02U2	Latte Textured
0722	Midnight Textured	02M2	Nevada
02A4	Milk	02X7	Platinum Metallic
0666	Platinum Metallic	02Z0	Satin Black
0705	Sterling Metallic	02X4	Silver Textured
0280	Warm White	02N0	Storm White Textured

### Dwelling Color Palette

03Q9	Special Gray	03Q4	Jonquill
03Q7	Bracing Blue	03P8	Garden Sage
03Q8	Honest Blue	03Q5	Emberglow
03Q0	Retreat	03Q3	Chamois
03Q1	Riverway	03Q6	Brandywine
03P9	Independent Gold	03Q2	Antique Red

## LAMINATES

GO Part #	HPL Laminate	Brand Code
DWDW	Designer White	Wilsonart D354-60 HPL
BKBK	Black	Wilsonart 1595-60 HPL
FGFG	Fashion Grey	Wilsonart 381-60 HPL
SGSG	Shadow	Wilsonart D96-60 HPL
DMGH	Slate Grey	Wilsonart D91-60 HPL
DZDZ	Desert Zephyr	Wilsonart 4841-60 HPL
SLSL	Steel Mesh	Wilsonart 4879-38 HPL
GYGY	Grey Mesh	Wilsonart 4877-38 HPL
B4B4	Bleached Legno	Formica 8845-58 HPL
NNNN	Neutral Twill	Formica 8826-58 HPL
S8S8	Sarum Twill	Formica 8827-58 HPL
BGBG	Brighton Walnut	Wilsonart 7922K-07 HPL
RHRH	River Cherry	Wilsonart 7937-38 HPL
BCBC	Biltmore Cherry	Wilsonart 7924K-07 HPL
WCWC	Wild Cherry	Wilsonart 7054-60 HPL
KMKM	Kensington Maple	Wilsonart 10776-60 HPL

# Mobile Teacher's Desks

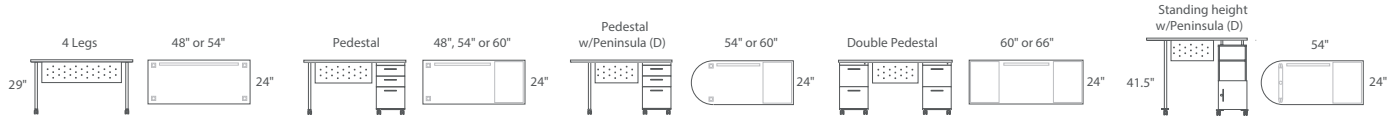

## 4 Leg

- Features four legs
- 48" and 54" widths
- Perforated modesty panel
- Locking 50mm casters
- Optional grommet \$30



## Single Pedestal

- Choose File File or Box File pedestal in left or right handed configuration
- 48", 54" and 60" widths
- Perforated modesty panel
- Standard or "D" Peninsula worksurface
- Locking 50mm casters
- Optional grommet \$30



## Double Pedestal

- Features 2 pedestals – File/File or File/File /Box/File
- 60" and 66" widths
- Perforated modesty panel
- Locking 50mm casters on pedestal fronts
- Optional grommet \$30

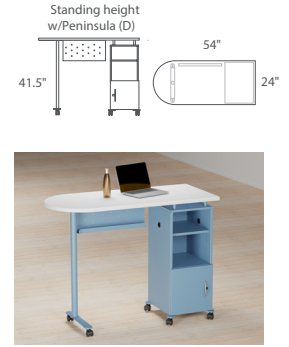

## Standing Height

- Side grommets for cord access
- Locking storage and open compartment with adj. shelf
- 50mm black/grey locking casters (2L/2NL) integrated into outrigger base for stability
- "D" Peninsula worksurface
- Satin nickel loop pull "S"
- Optional grommet \$30

H	D	W	Description	Part #	Part # Met.	Part # Color	Part # Lam/Edge	List Price
<b>4 Leg Desk</b>								
29	24	48	GOED 24" D x 48" W mobile desk with laminate worksurface, (4) legs, and perf mod panel	MTD2448	?	?		\$1,809
29	24	54	GOED 24" D x 54" W mobile desk with laminate worksurface, (4) legs, and perf mod panel	MTD2454	?	?		\$1,882
<b>Single Pedestal Desk</b>								
29	24	48	GOED 24" D x 48" W desk with laminate work surface and B/B/F ped with Satin nickel loop pull, 2 legs with casters, and perf mod panel	MTD-32448			?	\$2,177
29	24	54	GOED 24" D x 54" W desk with laminate work surface and B/B/F ped with Satin nickel loop pull, 2 legs with casters, and perf mod panel	MTD-32454			?	\$2,249
29	24	54	GOED 24" D x 54" W desk with Peninsula (D) laminate work surface and B/B/F ped with Satin nickel loop pull, 2 legs with casters, and perf mod panel	MTP-32454			?	\$2,378
29	24	60	GOED 24" D x 60" W desk with laminate work surface and B/B/F ped with Satin nickel loop pull, 2 legs with casters, and perf mod panel	MTD-32460			?	\$2,258
29	24	60	GOED 24" D x 60" W desk with Peninsula (D) laminate work surface and B/B/F ped with Satin nickel loop pull, 2 legs with casters, and perf mod panel	MTP-32460			?	\$2,428
29	24	48	GOED 24" D x 48" W desk with laminate work surface and F/F ped with Satin nickel loop pull, 2 legs with casters, and perf mod panel	MTD-22448			?	\$2,108
29	24	54	GOED 24" D x 54" W desk with laminate work surface and F/F ped with Satin nickel loop pull, 2 legs with casters, and perf mod panel	MTD-22454			?	\$2,180
29	24	54	GOED 24" D x 54" W desk with Peninsula (D) laminate work surface and F/F ped with Satin nickel loop pull, 2 legs with casters, and perf mod panel	MTP-22454			?	\$2,309
29	24	60	GOED 24" D x 60" W desk with laminate work surface and F/F ped with Satin nickel loop pull, 2 legs with casters, and perf mod panel	MTD-22460			?	\$2,189
29	24	60	GOED 24" D x 60" W desk with Peninsula (D) laminate work surface and F/F ped with Satin nickel loop pull, 2 legs with casters, and perf mod panel	MTP-22460			?	\$2,359
29	30	48	GOED 30" D x 48" W desk with laminate work surface and B/B/F ped with Satin nickel loop pull, 2 legs with casters, and perf mod panel	MTD-33048			?	\$2,427
29	30	54	GOED 30" D x 54" W desk with laminate work surface and B/B/F ped with Satin nickel loop pull, 2 legs with casters, and perf mod panel	MTD-33054			?	\$2,503
29	30	54	GOED 30" D x 54" W desk with Peninsula (D) laminate work surface and B/B/F ped with Satin nickel loop pull, 2 legs with casters, and perf mod panel	MTP-33054			?	\$2,732
29	30	60	GOED 30" D x 60" W desk with laminate work surface and B/B/F ped with Satin nickel loop pull, 2 legs with casters, and perf mod panel	MTD-33060			?	\$2,530
29	30	60	GOED 30" D x 60" W desk with Peninsula (D) laminate work surface and B/B/F ped with Satin nickel loop pull, 2 legs with casters, and perf mod panel	MTP-33060	?	?		\$2,846
<b>Double Pedestal Desk</b>								
29	24	60	GOED 24" D x 60" W mobile double pedestal desk with laminate worksurface, F/F and B/B/F peds with Satin nickel loop pull, and perf mod panel	MTD-52460			?	\$2,556
29	24	60	GOED 24" D x 60" W mobile double pedestal desk with laminate worksurface, (2) F/F peds with Satin nickel loop pull and perf mod panel	MTD-42460			?	\$2,487
29	24	66	GOED 24" D x 66" W mobile double pedestal desk with laminate worksurface, F/F and B/B/F peds with Satin nickel loop pull, and perf mod panel	MTD-52466			?	\$2,601
29	24	66	GOED 24" D x 66" W mobile double pedestal desk with laminate worksurface, (2) F/F peds with Satin nickel loop pull, and perf mod panel	MTD-42466	?	?		\$2,532
<b>Standing Height Desk</b>								
41.5	24	54	GOED 24" D x 54" Left Hand Standing Height Desk with Peninsula (D) laminate work surface and pen shelf and closed storage, Satin nickel loop pull, leg with 2 casters, and perf mod panel	LSMLD-2454			?	\$2,686
41.5	24	54	GOED 24" D x 54" Right Hand Standing Height Desk with Peninsula (D) laminate work surface and pen shelf and closed storage, Satin nickel loop pull, leg with 2 casters, and perf mod panel	RSMLD-2454			?	\$2,686

# Flexible Soft Seating

## FEATURES

- Durable, commercial quality urethane foam meets the current standards of CAL TB117-2013 for flammability and do not contain fire retardants.

Cube Ottoman and Curved Bench – Foamcraft P1860 foam topped with one inch of a soft top foam, P1835

Floor Pad – Foamcraft P1560

Floor Rocker – Foamcraft P1860N, 1.8 pound medium density, 60 ILD

- Double stitched seams
- Zipper closures provide additional strength as well as the ability to remove and replace the cover if damaged.
- Cube Ottoman includes 2" soft pocket handles on each side
- Super light materials make it a breeze to rearrange
- Integrated fabric fold allows for easy movement
- Floor Pad features loop strap for easy hanging storage
- Curved Bench radius complements Great Openings Curved Bookcase

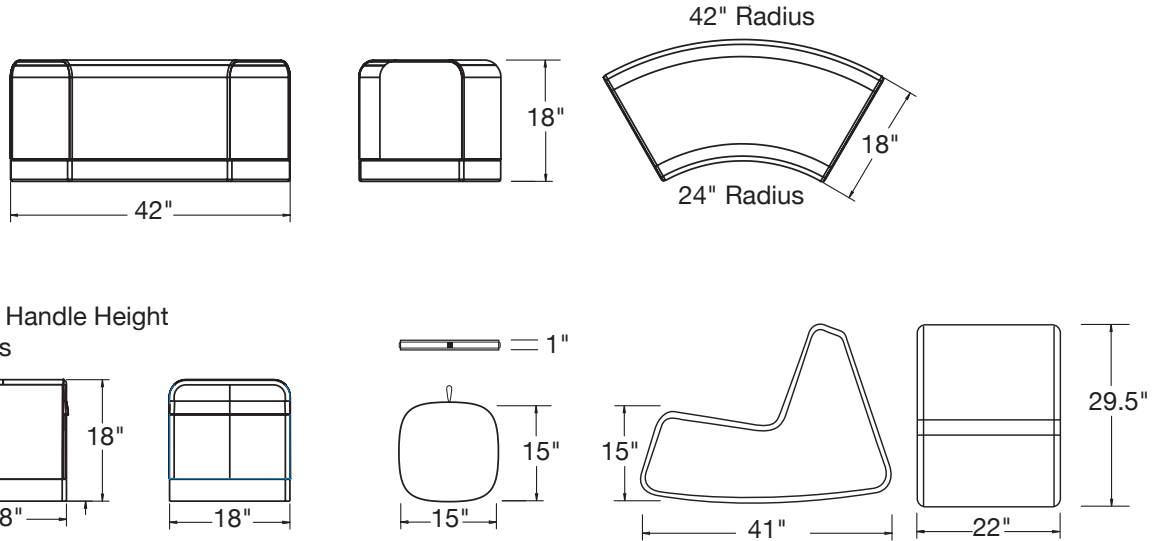

Curved Bench



Cube Ottoman



Floor Pad



Floor Rocker

H	D	W	Description	Yards Required	Part #	Fabric	List Price Grade 1 Fabric	List Price Grade 2 Fabric	List Price Grade 3 Fabric	List Price Grade 4 Fabric	List Price Grade 5 Fabric	List Price COM Fabric
18	18	42	GO Education Foam Curved Bench	3.2	COTTO	?	\$1,848	\$1,974	\$2,109	\$2,264	\$2,390	\$1,777
18	18	18	GO Education Foam Cube Ottoman	1.56	CUBE	?	\$875	\$936	\$1,002	\$1,078	\$1,139	\$804
1	15	15	GO Education Foam Floor Pad	0.47	FLPAD	?	\$192	\$211	\$231	\$254	\$272	\$152
15	41	22	Go Education Foam Floor Rocker	2.7	ROCK	?	\$1,761	\$1,868	\$1,982	\$2,113	\$2,219	\$1,691

# Helpmate Table



- Square and Amoeba laminate tops available in 16 laminates (HPL) with matching 3mm edge bands
- Metal cabinet construction available in 72 standard paint colors
- 4" locking casters
- Double sided storage with UM black lock
- Satin nickel loop pull "S"
- Side hook storage – 4 total
- 42" height features 1 adjustable shelf



Square



Amoeba

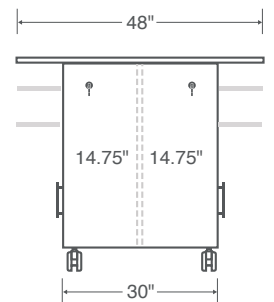
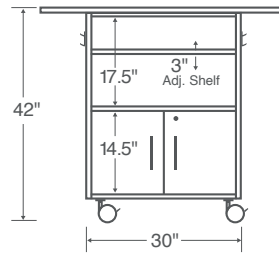
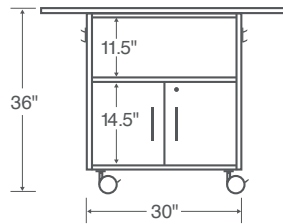

## ORDERING GUIDE

H	D	W	Description	Part #	Part # Metal Color	Part # Lam Finish	List Price	48" Square	48" Amoeba	54" Square	54" Amoeba
29	30	30	Base open cabinet, open storage with 1 adjustable shelf, NO doors	BOSBK29	?	?	\$1,591	\$2,267	\$2,525	\$2,518	\$2,669
36	30	30	Base open cabinet, 2 doors per side, 1 adjustable shelf, open storage above doors	BGSBC36	?	?	\$2,858	\$3,534	\$3,792	\$3,785	\$3,936
42	30	30	Base open cabinet, 2 doors per side, 1 adjustable shelf, open storage above doors	BGSBC42	?	?	\$3,076	\$3,752	\$4,010	\$4,003	\$4,154

# Helpmate Storage Cart



- Metal case available in 72 standard colors
- 4" casters, 2 locking, 2 non-locking
- UM series locks are black-faced, master-keyed, and core removable
- 3" high removable polycarbonate clear totes with drawer stops (6", 9" and 12" high totes available - For mixed tote size configuration requests, please contact Customer Success Team for a quote)

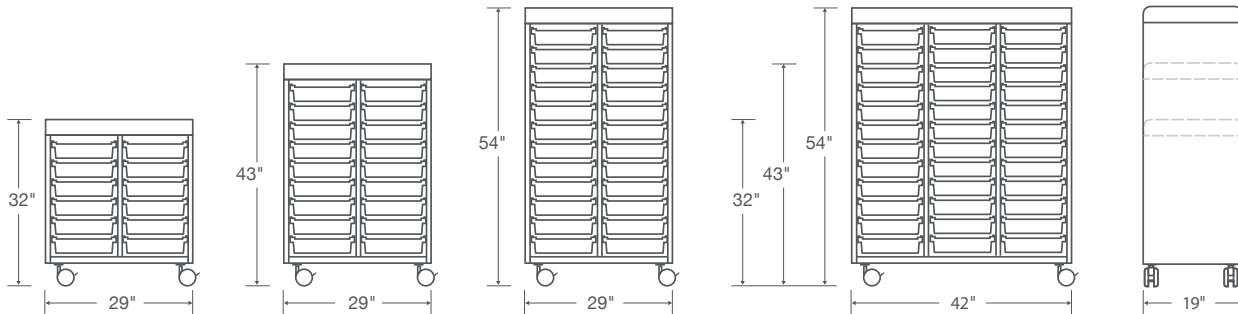
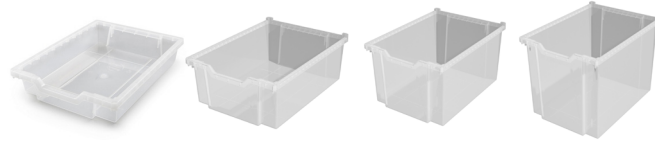

H	D	W	Description	Part #	Front	Metal Color	List Price
32	19	28	2 Columns, Open, 12 Polycarbonate Totes	RMC9KL2	?	?	\$2,440
32	19	28	2 Columns, Open, 6 Polycarbonate Totes, 1 Adjustable Shelf - Left	RMC9K2S	?	?	\$2,505
32	19	28	2 Columns, 2 Doors, 12 Polycarbonate Totes	MGS9KL2	?	?	\$3,419
32	19	28	2 Columns, 1 Door, 12 Polycarbonate Totes, 1 Adjustable Shelf - Left	MGS9K2S	?	?	\$2,930
32	19	42	3 Columns, Open, 18 Polycarbonate Totes	RMC9KL3	?	?	\$3,394
32	19	42	3 Columns, Open, 9 Polycarbonate Totes, 1 Adjustable Shelf - Left	RMC9K3S	?	?	\$2,605
32	19	42	3 Columns, 2 Doors, 18 Polycarbonate Totes	MGS9KL3	?	?	\$4,275
43	19	28	2 Columns, Open, 18 Polycarbonate Totes	RMC1LL2	?	?	\$3,297
43	19	28	2 Columns, Open, 9 Polycarbonate Totes, 1 Adjustable Shelf - Left	RMC1L2S	?	?	\$2,940
43	19	28	2 Columns, 1 Door, 9 Polycarbonate Totes, 1 Adjustable Shelf - Left	MGS1L2S	?	?	\$3,535
43	19	28	2 Columns, 2 Doors, 18 Polycarbonate Totes	MGS1LL2	?	?	\$4,165
43	19	42	3 Columns, Open, 27 Polycarbonate Totes	RMC1LL3	?	?	\$3,981
43	19	42	3 Columns, Open, 9 Polycarbonate Totes, 2 Adjustable Shelves - Left	RMC1L3S	?	?	\$2,865
43	19	42	3 Columns, 2 Doors, 27 Polycarbonate Totes	MGS1LL3	?	?	\$5,290
54	19	28	2 Columns, Open, 12 Polycarbonate Totes, 3 Adjustable Shelves - Left	RMC2L2S	?	?	\$3,020
54	19	28	2 Columns, Open, 24 Polycarbonate Totes	RMC2LL2	?	?	\$3,745
54	19	28	2 Columns, 1 Door, 12 Polycarbonate Totes, 3 Adjustable Shelves - Left	MGS2L2S	?	?	\$3,755
54	19	28	2 Columns, 2 Doors, 24 Polycarbonate Totes	MGS2LL2	?	?	\$4,555
54	19	42	3 Columns, 2 Doors, 36 Polycarbonate Totes	MGS2LL3	?	?	\$5,985
54	19	42	3 Columns, Open, 36 Polycarbonate Totes	RMC2LL3	?	?	\$4,638
54	19	42	3 Columns, Open, 12 Polycarbonate Totes, 3 Adjustable Shelves - Left	RMC2L3S	?	?	\$3,200
3	17	12	3" High Polycarbonate Totes	FS0120			\$42
6	17	12	6" High Polycarbonate Totes	FS0220			\$55
9	17	12	9" High Polycarbonate Totes	FS0320			\$85
12	17	12	12" High Polycarbonate Totes	FS2520			\$95

# Mobile Lecterns



- Raised platform laminate lectern surface
- Side grommets for cord access
- Locking storage and open compartment with adjustable shelf
- 50mm black/grey locking casters (2L/2NL) integrated into outrigger base for stability
- Satin nickel loop pull "S"

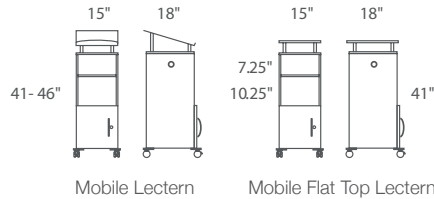

H	D	W	Description	Part #	Part # Metal Color	Part # Lam/Edge	List Price
41/46	18	15	GOED Mobile lectern with left hinge door and open storage	LG-4905	?	?	\$2,396
41/46	18	15	GOED Mobile lectern with right door and open storage	RG-4905	?	?	\$2,396
41/46	18	15	GOED Mobile flat top lectern with left hinge door and open storage	LG-4917	?	?	\$2,396
41/46	18	15	GOED Mobile flat top lectern with right door and open storage	RG-4917	?	?	\$2,396

# Mobile Storage



- Locking storage
- Adjustable shelf
- 31" and 44" heights available with 50mm locking inset casters or integrated outrigger base
- 58" height available in 75mm outrigger based casters
- Satin nickel loop pull "S"

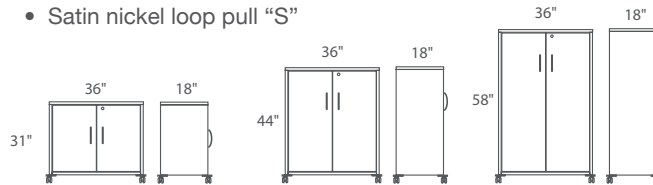

Outrigger Caster

H	D	W	Description	Part #	Part # Metal Color	List Price
31	18	36	GOED Mobile Storage cabinet with inset casters and 1 adjustable shelf, 2 doors, UM lock and satin nickel loop pull	MED3831	?	\$2,077
31	18	36	GOED Mobile storage cabinet with outrigger casters and 1 adjustable shelf, 2 doors, UM lock and satin nickel loop pull	MED3631	?	\$2,128
44	18	36	GOED Mobile storage cabinet with inset casters and 2 adjustable shelves, 2 doors, UM lock, satin nickel loop pull	MED3844	?	\$2,389
44	18	36	GOED Mobile storage cabinet with outrigger casters and 2 adjustable shelves, 2 doors, UM lock, satin nickel loop pull	MED3644	?	\$2,439
58	18	36	GOED Mobile storage cabinet with 3 adjustable shelves, 75mm outrigger casters, 2 doors, UM lock, satin nickel loop pull	MED3658	?	\$2,980

# Mobile Bookcases



- Adjustable shelf
- 31" and 44" heights available with 50mm locking inset casters or integrated outrigger base
- 58" height available in 75mm outrigger based casters

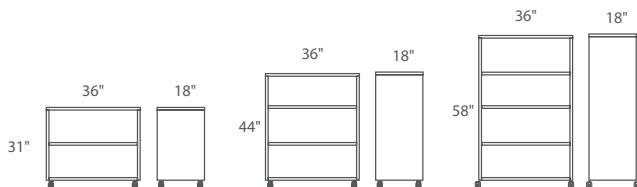

Outrigger Caster

H	D	W	Description	Part #	Part # Metal Color	List Price
31	18	36	GOED Mobile Bookcase with inset casters and 1 adjustable shelf	MEB3831	?	\$1,419
31	18	36	GOED Mobile Bookcase with outrigger casters and 1 adjustable shelf	MEB3631	?	\$1,619
44	18	36	GOED Mobile Bookcase with inset casters and 2 adjustable shelves	MEB3844	?	\$1,664
44	18	36	GOED Mobile Bookcase with outrigger casters and 2 adjustable shelves	MEB3644	?	\$1,813
58	18	36	GOED Mobile Bookcase with 75mm outrigger casters and 3 adjustable shelves	MEB3658	?	\$2,152

# Mobile Laminate Back-To-Back Bookcase



- Available in 16 laminates (HPL) with matching 3mm edge bands
- Adjustable metal shelves available in 72 standard paint finishes
- 75mm black casters (2L/2NL)
- Optional premium caster upgrade which includes outrigger base and soft wheel caster, choice of 72 standard paint finishes



Optional Outrigger Casters Add \$291

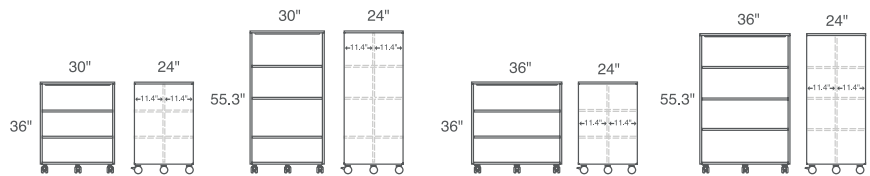

H	D	W	Description	Part #	Part # Metal Color	List Price
36	24	30	GOED Mobile Back-to-Back Bookcase with 2 adjustable shelves	B2B3036	?	\$3,149
55	24	30	GOED Mobile Back-to-Back Bookcase with 3 adjustable shelves	B2B3055	?	\$3,775
36	24	36	GOED Mobile Back-to-Back Bookcase with 2 adjustable shelves	B2B3636	?	\$3,175
55	24	36	GOED Mobile Back-to-Back Bookcase with 3 adjustable shelves	B2B3655	?	\$4,224

# Mobile Laminate Cubbys



- Available 16 laminates (HPL) with matching 3mm edge bands
- 75mm black casters (2L/2NL)
- Center caster for added support
- Optional premium caster upgrade which includes outrigger base and soft wheel caster, choice of 72 standard paint finishes
- Optional 1.5" thick integrated cushion on single height cubbys
- Optional translucent bins available in 2 heights
- Coat hook storage on cubby Locker



Optional Outrigger Casters Add \$291

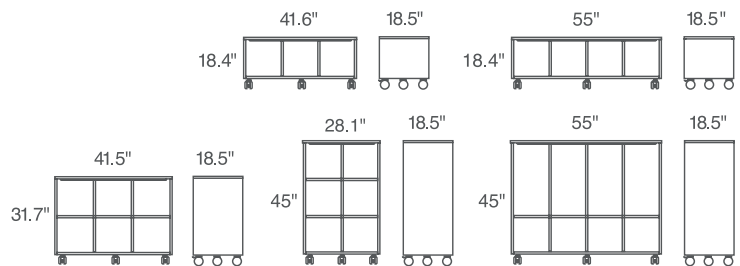

H	D	W	Description	Part #	Part # Lam Color	Fabric	List Price
18.4	18.5	41.6	HPL Mobile Open Cubby 3W x 1 HI	LOP8JY7	?	-	\$2,959
19.2	18.5	41.6	HPL Mobile Open Cubby with cushion 3W x 1 HI	LOP8JY7C	?	-	\$3,449
18.4	18.5	55	HPL Mobile Open Cubby 4W x 1 HI	LOP3JY6	?	-	\$2,982
19.2	18.5	55	HPL Mobile Open Cubby with cushion 4W x 1 HI	LOP3JY6C	?	?	\$3,512
31.7	18.5	41.5	HPL Mobile Open Cubby 3W x 2 HI	LOP1KY7	?	-	\$3,584
45	18.5	28.1	HPL Mobile Open Cubby Locker 2W x 3 HI	LOP9JY8	?	-	\$4,136
45	18.5	55	HPL Mobile Open Cubby Locker 4W x 2 HI	LOP2JY4	?	-	\$5,199
9	16.8	12.25	9 Inch Bin - translucent	F2520	?	-	\$82
12	16.8	12.25	12 Inch Bin - translucent	F0320	?	-	\$92

# M3 Cart



- Grey PET felt tray liners
- 12 gauge powder coated steel in 72 standard colors plus custom paint colors
- Includes black 37mm casters (2) locking and (2) non-locking
- Weight limits of 200 lbs

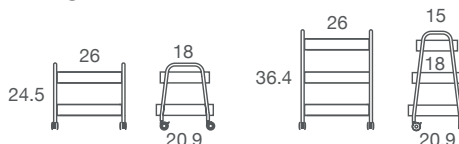

Description	H	D	W	Pkg Wt	Pkg Cube	Part #	Metal Color	List Price
M3 Mini Cart – 2 Tier	24-1/2	20.9	26	62 lb	13 ft	MIM2426	?	\$1,422
M3 Team Cart – 3 Tier	36.4	20.9	26	76 lb	19 ft	MIM3626	?	\$1,789

# Single & Double Sided Straight Mobile Bookcases

Laminate with Metal Back Panel and Shelves



- Available in 16 laminates (HPL) with matching 3mm edge bands
- Adjustable metal shelves and perforated metal back available in 72 standard paint finishes
- Six 76mm locking casters
- Optional top mounted pull handles
- Optional side magnets for grouping bookcases



Double sided shown with handle and magnet upgrades

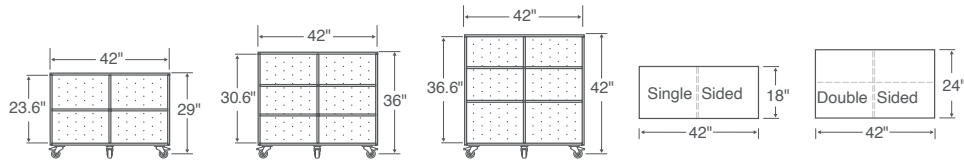

H	D	W	Description	Part #	+ Part # Metal Color	+ Part # Laminate Color	List Price
29	18	42	Single Sided Straight Mobile Bookcase With Metal Back Panel, 2 Adj Shelves, No Magnets, No Handles	EMSS-NN-291842	?	?	\$2,813
36	18	42	Single Sided Straight Mobile Bookcase With Metal Back Panel, 4 Adj Shelves, No Magnets, No Handles	EMSS-NN-361842	?	?	\$3,014
42	18	42	Single Sided Straight Mobile Bookcase With Metal Back Panel, 4 Adj Shelves, No Magnets, No Handles	EMSS-NN-421842	?	?	\$3,088
29	24	42	Double Sided Straight Mobile Bookcase With Metal Back Panel, 4 Adj Shelves, No Magnets, No Handles	EMSD-NN-292442	?	?	\$3,152
36	24	42	Double Sided Straight Mobile Bookcase With Metal Back Panel, 8 Adj Shelves, No Magnets, No Handles	EMSD-NN-362442	?	?	\$3,456
42	24	42	Double Sided Straight Mobile Bookcase With Metal Back Panel, 8 Adj Shelves, No Magnets, No Handles	EMSD-NN-422442	?	?	\$3,872
1.50	12		Add 2 Handles				\$202
			Add 4 Magnets				\$34

# Single & Double Sided Curved Mobile Bookcases

Laminate with Metal Back Panel and Shelves

- Case and adjustable shelves available in 16 laminates (HPL) with matching 3mm edge bands
- Perforated metal back available in 72 paint finishes
- Six 76mm locking casters
- Optional satin nickel top mounted pull handles
- Optional recessed side magnets for grouping bookcases

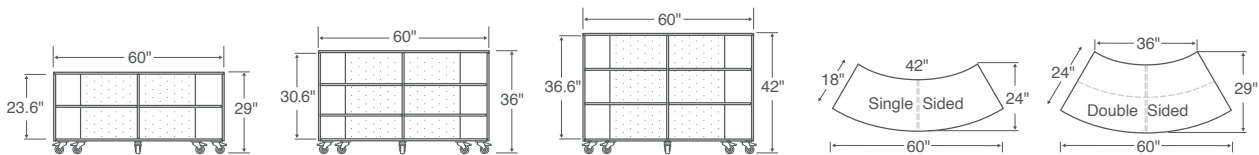
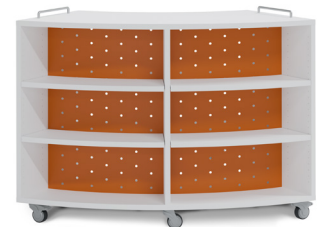

H	D	W	Description	Part #	+ Part # Metal Color	+ Part # Lam Finish	List Price
29	18	60	Single Sided Mobile Curved Bookcase With Metal Back Panel, 2 Adj Shelves, No Magnets, No Handles	EMCS-NN-291860	?	?	\$4,726
36	18	60	Single Sided Mobile Curved Bookcase With Metal Back Panel, 4 Adj Shelves, No Magnets, No Handles	EMCS-NN-361860	?	?	\$5,345
42	18	60	Single Sided Mobile Curved Bookcase With Metal Back Panel, 4 Adj Shelves, No Magnets, No Handles	EMCS-NN-421860	?	?	\$5,629
29	24	60	Double Sided Mobile Curved Bookcase With Metal Back Panel, 4 Adj Shelves, No Magnets, No Handles	EMCD-NN-292460	?	?	\$5,345
36	24	60	Double Sided Mobile Curved Bookcase With Metal Back Panel, 8 Adj Shelves, No Magnets, No Handles	EMCD-NN-362460	?	?	\$5,952
42	24	60	Double Sided Mobile Curved Bookcase With Metal Back Panel, 8 Adj Shelves, No Magnets, No Handles	EMCD-NN-422460	?	?	\$6,378
			Add Handles				\$202
			Add Magnets				\$34

## Laminate Mobile Cabinet

- Available in 16 laminates (HPL) with matching 3mm edge bands
- Magnetic option is recessed into sides to allow quick pairing
- 4" locking casters
- UM black lock
- Adjustable shelf



H	D	W	Description	Part #	Front	Lam/Edge #	List Price
30	24	30	Mobile Cabinet 2 Doors Magnets On Both Sides	EBBC-302430	?	?	\$2,863
30	24	36	Mobile Cabinet 2 Doors Magnets On Both Sides	EBBC-302436	?	?	\$3,061
30	24	48	Mobile Cabinet 2 Doors Magnets On Both Sides	EBBC-302448	?	?	\$3,373
36	24	30	Mobile Cabinet 2 Doors Magnets On Both Sides	EBBC-362430	?	?	\$3,061
36	24	36	Mobile Cabinet 2 Doors Magnets On Both Sides	EBBC-362436	?	?	\$3,260
36	24	48	Mobile Cabinet 2 Doors Magnets On Both Sides	EBBC-362448	?	?	\$3,571
30	24	30	Mobile Cabinet 2 Doors No Magnets	EBNC-302430	?	?	\$2,779
30	24	36	Mobile Cabinet 2 Doors No Magnets	EBNC-302436	?	?	\$2,976
30	24	48	Mobile Cabinet 2 Doors No Magnets	EBNC-302448	?	?	\$3,260
36	24	30	Mobile Cabinet 2 Doors No Magnets	EBNC-362430	?	?	\$2,976
36	24	36	Mobile Cabinet 2 Doors No Magnets	EBNC-362436	?	?	\$3,146
36	24	48	Mobile Cabinet 2 Doors No Magnets	EBNC-362448	?	?	\$3,430

## Laminate Base Cabinet

- Available in 16 laminates (HPL) with matching 3mm edge bands
- UM black lock
- Adjustable shelf



H	D	W	Description	Part #	Front	Lam/Edge #	List Price
30	24	30	Base Cabinet 2 Doors No Magnets	EBNN-302430	?	?	\$2,063
30	24	36	Base Cabinet 2 Doors No Magnets	EBNN-302436	?	?	\$2,200
30	24	48	Base Cabinet 2 Doors No Magnets	EBNN-302448	?	?	\$2,449
36	24	30	Base Cabinet 2 Doors No Magnets	EBNN-362430	?	?	\$2,234
36	24	36	Base Cabinet 2 Doors No Magnets	EBNN-362436	?	?	\$2,347
36	24	48	Base Cabinet 2 Doors No Magnets	EBNN-362448	?	?	\$2,608

# Laminate Stack Shelving

- Available in 16 laminates (HPL) with matching 3mm edge bands
- Combinations begin with a starter, and continue using adders and finishes with an ender
- Adjustable shelves
- To ensure stability, freestanding shelving should be installed against a wall or other solid object

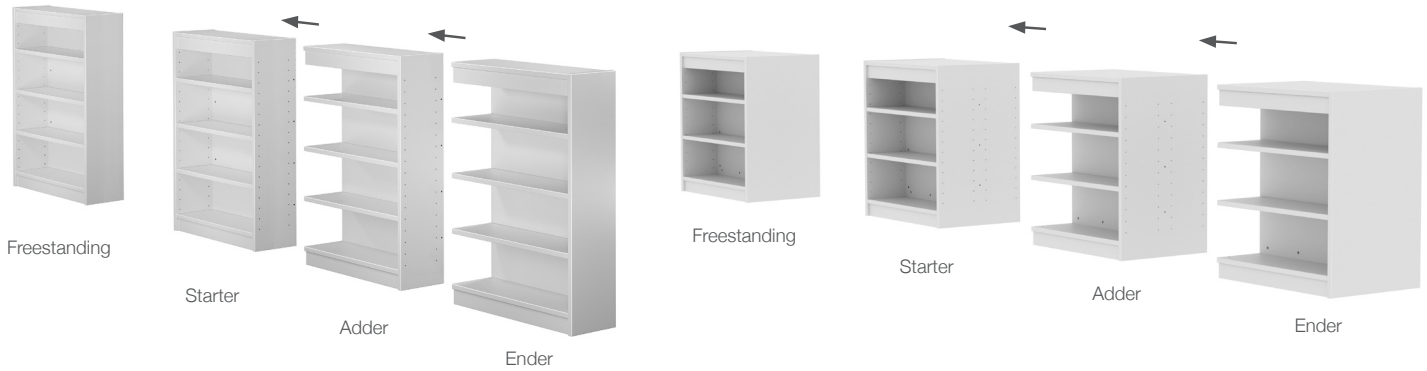

H	D	W	Description	Part #	Lam/Edge #	List Price
29	12	36	Single sided HPL freestanding shelving, 1adjustable lam shelf	EFSS-291236	?	\$1,548
40	12	36	Single sided HPL freestanding shelving, with 2 adjustable lam shelves	EFSS-401236	?	\$2,083
51	12	36	Single sided HPL freestanding shelving, with 3 adjustable lam shelves	EFSS-511236	?	\$2,611
66	12	36	Single sided HPL freestanding shelving, with 4 shelves	EFSS-661236	?	\$3,079
77	12	36	Single sided HPL freestanding shelving, with 5 shelves	EFSS-771236	?	\$3,426
29	24	36	Double sided HPL freestanding shelving, 1 adjustable lam shelf per face	EFSD-292436	?	\$2,550
40	24	36	Double sided HPL freestanding shelving, with 2 adjustable lam shelves per face	EFSD-402436	?	\$3,266
51	24	36	Double sided HPL freestanding shelving, with 3 adjustable lam shelves per face	EFSD-512436	?	\$4,303
66	24	36	Double sided HPL freestanding shelving, with 4 shelves per face	EFSD-662436	?	\$4,627
77	24	36	Double sided HPL freestanding shelving, with 5 shelves per face	EFSD-772436	?	\$4,705
29	12	36	Single sided HPL starter shelving, 1 adjustable lam shelf	ESSS-291236	?	\$1,559
40	12	36	Single sided HPL starter shelving, with 2 adjustable lam shelves	ESSS-401236	?	\$2,094
51	12	36	Single sided HPL starter shelving, with 3 adjustable lam shelves	ESSS-511236	?	\$2,622
66	12	36	Single sided HPL starter shelving, with 4 shelves	ESSS-661236	?	\$3,091
77	12	36	Single sided HPL starter shelving, with 5 shelves	ESSS-771236	?	\$3,437
29	24	36	Double sided HPL starter shelving, 1 adjustable lam shelf per face	ESSD-292436	?	\$2,561
40	24	36	Double sided HPL starter shelving, with 2 adjustable lam shelves per face	ESSD-402436	?	\$3,277
51	24	36	Double sided HPL starter shelving, with 3 adjustable lam shelves per face	ESSD-512436	?	\$4,314
66	24	36	Double sided HPL starter shelving, with 4 shelves per face	ESSD-662436	?	\$4,638
77	24	36	Double sided HPL starter shelving, with 5 shelves per face	ESSD-772436	?	\$4,716
29	12	36	Single sided HPL Adder shelving, 1 adjustable lam shelf	EASS-291236	?	\$1,526
40	12	36	Single sided HPL Adder shelving, with 2 adjustable lam shelves	EASS-401236	?	\$1,851
51	12	36	Single sided HPL Adder shelving, with 3 adjustable lam shelves	EASS-511236	?	\$2,077
66	12	36	Single sided HPL Adder shelving, with 4 shelves	EASS-661236	?	\$2,743
77	12	36	Single sided HPL Adder shelving, with 5 shelves	EASS-771236	?	\$3,184
29	24	36	Double sided HPL Adder shelving, 1 adjustable lam shelf per face	EASD-292436	?	\$2,220
40	24	36	Double sided HPL Adder shelving, with 2 adjustable lam shelves per face	EASD-402436	?	\$2,831
51	24	36	Double sided HPL Adder shelving, with 3 adjustable lam shelves per face	EASD-512436	?	\$3,261
66	24	36	Double sided HPL Adder shelving, with 4 shelves per face	EASD-662436	?	\$4,153
77	24	36	Double sided HPL Adder shelving, with 5 shelves per face	EASD-772436	?	\$4,231
29	12	36	Single sided HPL Ender shelving, 1 adjustable lam shelf	EESS-291236	?	\$1,509
40	12	36	Single sided HPL Ender shelving, with 2 adjustable lam shelves	EESS-401236	?	\$1,888
51	12	36	Single sided HPL Ender shelving, with 3 adjustable lam shelves	EESS-511236	?	\$2,120
66	12	36	Single sided HPL Ender shelving, with 4 shelves	EESS-661236	?	\$2,807
77	12	36	Single sided HPL Ender shelving, with 5 shelves	EESS-771236	?	\$3,254
29	24	36	Double sided HPL Ender shelving, 1 adjustable lam shelf per face	EESD-292436	?	\$2,262
40	24	36	Double sided HPL Ender shelving, with 2 adjustable lam shelves per face	EESD-402436	?	\$3,078
51	24	36	Double sided HPL Ender shelving, with 3 adjustable lam shelves per face	EESD-512436	?	\$3,334
66	24	36	Double sided HPL Ender shelving, with 4 shelves per face	EESD-662436	?	\$4,241
77	24	36	Double sided HPL Ender shelving, with 5 shelves per face	EESD-772436	?	\$4,320

# Personal Storage

For complete listing of additional storage options please go [here](#)

## Slim XLT



- Bottom drawer may be specified as single-sided (left or right) or two-sided
- A two-sided drawer includes file bars to accommodate letter or legal hanging files
- A concealed top drawer is accessible when bottom drawer is open
- Cushion is 1" foam
- Linear yardage required for COM fabric (20 units or fewer): Slim - 3/4 yard
- Unless otherwise specified, the fabric grain on cushions will be applied "front-to-back"
- 75mm black casters (2L/2NL) integrated into outrigger base for added stability and higher clearance
- Ergonomic, three-stage telescoping handle
- Rear storage bag with one full-length and one half-length pocket for laptop and accessories
- Self closing slides keep drawer closed during travel

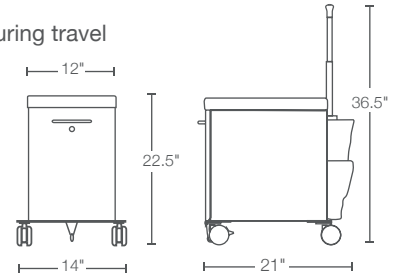

H	D	W	Description	Top Option	Drawer access from side	Pkg Wt	Pkg Cube	Part #	Front	Part #	Metal Color	Fabric #	GR 1 Price	GR 2 Price	GR 3 Price	GR 4 Price	GR 5 Price	COM Price
22-1/2	21	14	XLT one-sided drawer	cushion	left	54 lb	3.8 ft	SLU	?	5650C	?	?	\$1,386	\$1,496	\$1,541	\$1,586	\$1,623	\$1,380
22-1/2	21	14	XLT one-sided drawer	cushion	right	54 lb	3.8 ft	SRU	?	5650C	?	?	\$1,386	\$1,496	\$1,541	\$1,586	\$1,623	\$1,380
22-1/2	21	14	XLT two-sided drw. & file bars	cushion	n/a	54 lb	3.8 ft	STU	?	5650C	?	?	\$1,425	\$1,533	\$1,576	\$1,621	\$1,658	\$1,419

## Odie



- All Great Openings products meet or exceed applicable ANSI-BIFMA standards for durability and safety
- 14 gauge steel frame and 12 gauge steel door, available in 72 standard colors and custom powder coat finishes
- Laminate interior shelf, back and fascia, available in white, grey or black
- Dual Durometer 75mm black/grey locking casters (2L/2NL) integrated into outrigger base for stability
- Ergonomic, three-stage telescoping handle
- Drawer bin includes self-closing suspension with file bar to accommodate side-to-side letter or legal files
- Detachable hook for hanging bags
- 200 lb weight limit
- UM series lock, core-removable, master keyed, matte black finish
- Optional low-profile vinyl pad with wrap-around design and magnetic attachment available in four colors

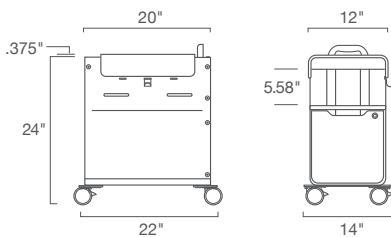

### Laminates



M-1573-60 Frosty White



M-631-60 Classic Black



M-D381-60 Grey

### Vinyls



STP 60 Raven



STP 66 Mist



STP 65 Smith



STP 67 Fire

Description	H	D	W	Pkg Wt	Pkg Cube	Part #	Metal Color	Laminate/Vinyl	List Price
Odie	24	20	12	62 lb	5.3 ft	LNA-2418	?	?	\$1,658
Magnetic Vinyl Pad	3/8	18	15	na	na	NACX0018XXXXX		?	\$333

# Admin Storage

For complete listing of additional storage options please go [here](#)

## Lateral File



- Counterweight is required if not ganged together or otherwise anchored
- Trace lateral files with flipper door on top, when installed in a “built-in” wall situation will require a minimum of 1-1/2” clearance above the cabinet for the flipper door to go up and over the top

H	D	W	Cabinet Style	Contains	Pkg Wt	Pkg Cube	Part #	Front	Part #	Metal Color	Price
28-3/8	18-1/4	36	2-high	2 drawers	114 lb	14.0 ft	RG	?	C401	?	\$1,556
39-7/8	18-1/4	36	3-high	3 drawers	156 lb	19.6 ft	RG	?	C702	?	\$2,096
51-3/8	18-1/4	36	4-high	4 drawers	198 lb	26.0 ft	RG	?	D103	?	\$2,578

## Double Door Storage Cabinet



- Common laminate tops are available
- 140lb shelf load capacity  
Note: each shelf is 3/4” tall
- 168lb cabinet top weight capacity

H	D	W	Description	Pkg Wt	Pkg Cube	Part #	Door Style	Part #	Metal Color	Price
28-3/8	18-1/4	36	2-high double door 1 adjustable shelf	78 lb	15.5 ft	CG	?	02F3	?	\$1,725
39-7/8	18-1/4	36	3-high double door 2 adjustable shelves	100 lb	20.6 ft	CG	?	05F3	?	\$1,959
51-3/8	18-1/4	36	4-high double door 3 adjustable shelves	125 lb	26.1 ft	CG	?	08F3	?	\$2,346

## Storage Towers



- Single lock captures all doors and drawers
- Coat closet includes side-to-side coat rod

H	D	W	Hinge	Drawer Options	Pkg Wt	Pkg Cube	Part #	Front Style	Part #	Metal Color	Price
51-3/8	23-1/2	15-1/4	left	file/file 24.5" cupboard	85 lb	14.2 ft	CL	?	K409	?	\$1,995
51-3/8	23-1/2	15-1/4	left	box/box/file 24.5" cupboard	87 lb	14.2 ft	CL	?	K411	?	\$2,190

H	D	W	Coat Door	Drawer Options	Pkg Wt	Pkg Cube	Part #	Front	Part #	Metal Color	Price
51-3/8	23-1/2	23-1/2	left	2 file drawers, 24.5" cupboard	164 lb	21.0 ft	DG	?	J654	?	\$3,265

# COMMERCIAL TERMS & CONDITIONS

These conditions of sale supersede all previous selling policies. Prices, discounts, lead-times and product offerings are subject to change without notice.

## Order Placement

Great Openings requires that all orders be submitted in writing to avoid errors and/or duplication. Sales of all Great Openings' products are made only on the Company's standard terms and conditions of sale, unless modified in writing by an authorized Great Openings representative.

Orders received at Great Openings after 4:00pm EST will be processed the following day.

## Order Acknowledgement

We diligently issue order acknowledgements via e-mail within 24 hours of purchase order receipt. If you do not receive an acknowledgement within 24 hours, please call our Customer Service department to determine the reason; we may not have received your order, or we may have questions that are delaying order entry.

**PLEASE CHECK  
ACKNOWLEDGEMENTS  
FOR ERRORS  
IMMEDIATELY UPON RECEIPT.**

The order acknowledgement process is designed to ensure protection for both the buyer and the seller. We strongly urge the buyer to make sure the acknowledgement accurately reflects the intended purchase.

## Order Discrepancies

Great Openings will not be held responsible for extra costs due to errors resulting from purchase order inaccuracies. If and when a discrepancy is detected on the purchase order or acknowledgement, all corrections must be received in writing before further order processing can occur.

## Changes, Cancellations

Orders may not be changed, corrected or cancelled, in whole or in part, after Great Openings has issued its order acknowledgement without the written consent of an authorized Great Openings representative. Special order items (special or custom cabinets, Customer's Own Materials (COM) fabric and laminates) already in production are not subject to change or cancellation under any circumstances.

## Canadian Orders

Canadian orders may be processed using this price book. The pricing and payment terms included in this book are in U.S. funds. Custom brokerage fees and GST/HST taxes will be charged as separate line items on the invoice. All prices are freight included; FOB: Destination. A Regional Small Order Freight Charge applies to all orders less than \$5,000 list (does not apply to accessory orders). See regional map for applicable fee.

## Lead-Time

Lead-times are measured in working days, and begin after receipt of clean order.

Lead-times may change without notice. Stated lead-times will not commence until purchase order is actually entered into our system. We are not responsible for delays caused by order discrepancies or late receipt of COM items.

## Special Shipping Instructions

Great Openings will accommodate special shipping/delivery requests whenever possible. Purchaser will be responsible for any and all extra costs incurred by reason of Great Openings complying with a special shipping request. Examples of special requests that may cause extra charges (dollar amounts shown are approximate, actual amounts may vary):

- special carrier/lift gate: starting at \$85.00
- inside delivery: starting at \$50.00
- expediting, re-consignment, delays causing carrier storage: starting at \$50.00
- truck load delivery times after 3:00 pm, Monday through Thursday start at \$400
- truck load delivery after 3:00 pm, on Friday: \$800
- delivery times outside normal business hours including weekends and holidays: starting at \$450.00 per truck
- exact, narrow scheduling window (elevator time): starting at \$150.00
- non-commercial/residential deliveries: starting at \$60.00

The maximum amount of time allowed for off-loading product from trailers is 3 hours. Carrier costs associated with any additional delivery time will be charged to the dealer. Any additional charges that result from the purchaser failing to accept a shipment as agreed upon will be the responsibility of the purchaser.

## Special Delivery Charges

Once a delivery truck arrives at a destination, if the recipient is not ready to accept delivery as scheduled and the truck must wait, deliver "after hours", or make a second drop at a later time, the carrier charges a penalty for that delay which Great Openings must pass on to the customer.

These charges are as follows (dollar amounts shown are approximate, actual amounts may vary):

- Night Delivery:
- 3:30-4:30 p.m.: \$400 additional charge
  - 4:30-5:30 p.m.: \$450 additional charge
  - 5:30 p.m. and later: \$500 additional charge
- Detention fee will be \$75 per hour after two hours. Drop charge will be \$75 per drop.

Weekend and holiday deliveries will be quoted per load depending on location and delivery time.

Please use caution when planning and communicating delivery requirements so that these exorbitant fees will not be necessary.

## Key-Alike Services

Key-alike service is offered free of charge provided the key-alike request is associated with an order for a matching quantity of cabinets. Additional key/core sets, master and core keys are available for a nominal charge. All Great Openings products are keyed randomly prior to shipment. Special cores and keys are shipped separately to be changed-out in the field. See the Specification Guide in the front of this book.

## COM & Fabric Grades

If COM materials are difficult to apply or inadequate, Great Openings reserves the right to apply extra charges or to cancel the order. Great Openings has no control over COM material quality or performance and will not be held responsible for material defects or damage caused by improper use or application.

## Limited Lifetime Warranty

Great Openings warrants its Great Openings brand Metal Case-goods, Trace and Cayenne Desks, Files, Storage, Lockers and Sparkeology products to be free from defects in materials and workmanship for the life of the product, except as set forth below. This warranty applies to Great Openings products delivered in the United States and Canada and is non-transferable. The warranty is valid from the date of delivery to the End User. This warranty does not cover ordinary wear and tear, improper installation, outdoor use, or direct mis-use of the product. This warranty does not apply to Customer's Own Materials (COM) for fabric, laminates, or edge bands. In addition, supplier warranties will apply to products not manufactured by Great Openings. End User means the final purchaser acquiring a product from Great Openings or the Great Openings Dealer channel for the purchaser's own use and not for resale, remarketing or distribution. Great Openings will not be liable for loss of time, inconvenience, commercial loss, incidental or consequential damages.

## EXCEPTIONS TO THE LIFETIME COVERAGE

### Laminate Lockers – 12 years

Single, Double, Multi-purpose, Quad, and Cubby Laminate Lockers and includes both TFL and HPL options.

### Tables – 5 years

Sparkeology Line Products: Pete and Oscar

### Seating and Tables – 2 years

Height Adjustable Tables, Sparkeology Line Products: Ben, Manny, Sly, Sophia, Cupcake, and Lily

### High Wear Parts – 1 year

Mobile Storage Casters, Gas Rods, Cushion Pads, Hinges, Power and Electrical components

### Surfaces Materials Disclaimer:

- Exact matching of surface finishes, including an exact match to cuttings, samples, or swatch cards are not covered.
- Changes in surface finishes and colorfastness due to aging, exposure to artificial light or exposure to direct sunlight are not covered.

### Credit Card Transaction Fee

Credit card payments in excess of the following thresholds will be subject to a 2.16% transaction fee. Please note that Great Openings also accepts payments via ACH, wire transfer, and check – all free of charge.

Type of Sale	Credit Card Threshold (per sales order)	Fee Assessed for Amount Over this Threshold
Commercial	\$10,000.00	2.16%
GSA: Project in USA	\$20,000.00	2.16%
GSA: Project outside of USA	\$30,000.00	2.16%

# COMMERCIAL TERMS & CONDITIONS

## Regional Pricing

Great Openings reserves the right to adopt regional discount programs and small order freight charges to address the freight cost impact applicable to each geographic region. A buyer's region will be determined by shipping destination.

## Payment Terms

Orders are invoiced at the time of shipment and payment is due upon receipt of the invoice. Invoices unpaid thirty (30) days after the invoice date are subject to a late payment charge in the amount of one and one-half percent (1-1/2%) per month on the unpaid balance until paid. Great Openings reserves the right to modify or establish special credit arrangement for any customers at any time at its sole discretion. All prices are subject to change without notice.

## Remit to:

**GREAT OPENINGS**  
**PO Box 7581**  
**Carol Stream, IL 60197-7581**

## Taxes

All sales, use, excise and other applicable taxes (excluding only taxes on the net income of Great Openings) are the purchaser's responsibility and will be invoiced to the purchaser. If purchaser claims an exemption from such taxes, it shall be the purchaser's responsibility to furnish an appropriate exemption certificate to Great Openings.

For Canadian orders, Great Openings does invoice and collect for GST/HST.

## Freight Policy

All prices are freight included, F.O.B. Destination. Prices are based on a single shipment to a single location. A Small Order Freight Charge applies to all orders less than \$5,000 list (does not apply to orders for accessories).

See the map below for Small Order Freight Charge by destination. Effective March 1, 2017, orders totaling less than \$5,000 list that are shipped to Michigan, Wisconsin, Illinois, Indiana, Ohio, Kentucky, and West Virginia a Small Order Freight Charge of \$100 net will apply. For orders totaling less than \$7,500 list that are shipped to the remainder of the continental U.S. and southern portions of Canada as shown on the map, a Small Order Freight Charge of \$200 net will apply. For Alaska, Hawaii, and all other portions of Canada, please call for a quote.

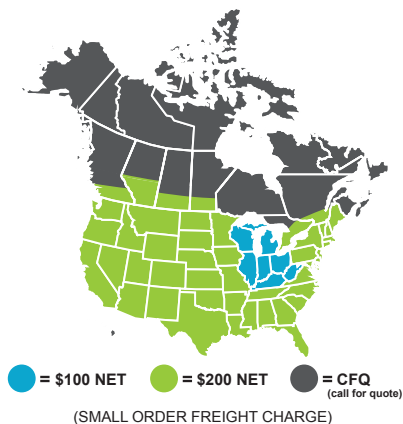

A flat rate \$15 FedEx shipping and handling fee will be charged at time of purchase order to handle incidental small product packages (i.e. keys, name plates, file bars, etc.).

## Standard Packaging

All Great Openings' products are packaged in accordance with industry standards and common carrier requirements. Pedestal products are individually boxed with polystyrene corner guard inserts, then palletized, and shrink wrapped. Lateral and storage product packaging consists of corrugated top and bottom trays, corner guards, palletized, shrink wrapped and labeled. For full truckloads only, upon special requests, we can provide a blanket wrapped shipment; please call for a quote.

## Shipment and Delivery

Freight is included in the prices as displayed in this price book. All shipments are FOB destination: free freight to destination in the continental United States. Shipments outside the contiguous 48 states will be freight collect from exit port. Exception for Canadian shipments; see the section on Canadian orders. Great Openings will select the mode and carrier of shipment.

- Partial shipments may be necessary and are at the discretion of Great Openings.
- Great Openings cannot guarantee exact time of delivery.
- Any charges resulting from late deliveries beyond our control are not the responsibility of Great Openings.
- Ship dates contained in order acknowledgements are estimated and not guaranteed.

Great Openings will often consolidate orders to maximize shipping efficiency. In these situations, a customer's designated ship date may change, though Great Openings will make every effort to ensure that requested delivery dates are still met.

## Product Storage Fees

Once an order enters production, it is not possible to stop production on that order if a last-minute request is made to delay shipment. If it is absolutely necessary to hold the product at Great Openings for a later ship date, a holding fee of \$7 net per pallet or \$100 net per trailer will be assessed each week and partial week until the product ships. Weekly storage fees will be the responsibility of the purchaser on any delayed shipment of a produced order.

## Returns

Great Openings will not accept returned goods.

## Claim Policy

**It is the purchaser's responsibility to examine goods upon receipt and to notify Great Openings customer service with any concerns. Any claims against Great Openings for apparent defects, errors or shortages must be made by the purchaser within five (5) working days after any delivery. Failure by the purchaser to make any claim against Great Openings within (5) days shall constitute acceptance of the goods and waiver of any apparent defects, errors or shortages.**

## Freight Damage Claims

Great Openings' terms are FOB destination, Great Openings is not responsible for damage that occurs in transit. All Great Openings' products are carefully inspected prior to shipment. The carrier signs for all goods received in apparent good order.

**It is the buyer's responsibility to inspect goods upon receipt for both apparent and concealed damage. In the rare instance where shipping damage is found, we ask the purchaser NOT to refuse shipment. Accepting shipment will give us more opportunities to remedy the situation through parts (fronts, tops) replacement and within the guidelines of the stated terms.**

## Claim and Replacement Policy

In the case of documented shipping damage, Great Openings will file a claim with the carrier and issue at no charge any replacement parts or product only if the purchaser meets the following conditions:

- Product is shipped via a Great Openings designated carrier
- Accept the shipment
- Retain packaging
- Inspect the shipment and document damage on the bill of lading
- Contact Great Openings immediately upon discovery and documentation of damage

Failure of purchaser to meet these conditions will prevent Great Openings from obtaining carrier reimbursement and thereby require us to charge full price for product replacement.

**Great Openings is not responsible for labor or trip costs associated with freight damage product replacement.**

## Concealed Damage Policy

Concealed damage (damage discovered after acceptance with no bill of lading documentation) should be reported to Great Openings immediately upon discovery. Please retain packaging and request carrier inspection immediately. Carrier liability ceases 7 calendar days after receipt of shipment. Great Openings will investigate on a case-by-case basis. In any case, Great Openings assumes no liability beyond the 7-day carrier liability and reserves the right to apply no remedy and/or various remedies dictated by individual event circumstances.

The buyer may make NO DEDUCTION UNDER ANY CIRCUMSTANCES ensuing from freight claims when settling invoices with Great Openings.

## Service

Please contact Great Openings with any service concerns:

Great Openings  
902 E. Fourth Street  
Ludington, MI 49431  
Ph: 888-712-8582



902 East 4th Street  
Ludington, MI 49431  
888-712-8582  
greatopenings.com  
goorders@greatopenings.com