



PRICE BOOK

Prices Effective August 3, 2020

greatopenings.com

Updates and revisions to this book:

Date	Page	Update
3/13/20	18	Corrected Molly heights with cushion option
3/17/20	12	Changed additional Keys pricing
4/27/20		GSA updates
5/19/20	117	Added worksurface thickness requirements for modesty bracket
8/3/20		Locker Expansion
8/27	135	GSA Contract Date Extended
9/29		Laminate Ganging Kits
11/23	16	Odie Personal Storage
12/15	122	Hutch and Task Lighting



Specification Guide

- 4 Quick Reference for Ordering
- 5 Metal Colors
- 6 Laminates
- 9 Fabrics
- 11 Locks
- 12 Key Alike
- 13 Product Care and Maintenance

Trace Personal Storage & Pedestals

- 14 Specifications
- 15 Personal Storage
- 20 Pedestals
- 22 Under Work Surface Storage
- 23 Freestanding Pedestals
- 25 Pedestal Accessories

Trace Lateral Files

- 26 Specifications
- 27 Lateral Files
- 33 Laminate Tops - Trace Laterals
- 37 Trace Lateral Accessories

Recessed Front Lateral Files

- 39 Specifications
- 40 Lateral Files
- 42 Recessed Door Lateral Files
- 44 Laminate Tops - Recessed Front Laterals
- 45 Recessed Front Lateral Accessories

Trace Lockers

- 46 Specifications
- 48 Metal Lockers
- 56 Metal Locker Accessories
- 57 Ganging Kit & Locker Door Number Plates
- 58 Laminate Lockers
- 66 Laminate Locker Accories
- 67 Laminate Tops - Lockers
- 68 How to Order Multicolored Locker Doors

Trace Wardrobe Towers

- 77 Specifications
- 78 Wardrobe Towers

Storage Cabinets

- 83 Specifications
- 84 Double Door Storage Cabinets

Trace Bookcases

- 87 Specifications
- 88 Bookcases

Cayenne Storage & Desk Components

- 90 Specifications
- 91 Cayenne Workstation Typicals
- 93 Cayenne Storage
- 96 Cayenne Accessories

Height Adjustable Tables

- 101 Specifications
- 102 Height Adjustable Tables
- 103 Desktop Sit-Stand

Trace Freestanding Desks

- 104 Specifications
- 107 Trace Bare Bones Desks
- 109 Trace Desk Shells
- 114 Trace Corner Desks
- 115 Trace Extended Corner Desks
- 116 Trace Extended Corner Desks End-of-Run
- 117 Trace Bridge Desks
- 118 Trace Desk Components Sold Separately
- 120 Trace Desk Modesty Panels Sold Separately
- 121 Trace Desk Work Surface Panels Sold Separately

Desk Accessories

- 122 Desk Hutch
- 122 Task Lighting
- 123 Personal Drawer
- 124 Acrylic Screens
- 125 Metal Modesty Panels
- 126 Tackable Privacy Screens
- 127 Electrical Components
- 130 Desk Accessories

Sparkeology

- 131 Pete, Cupcake
- 132 Sly, Manny
- 133 Ben, Sofia
- 134 Oscar, Lily, Flip

135 Commercial Terms & Conditions

137 GSA Terms & Conditions

Great Openings Price Book August 2020

Great Openings
902 E. 4th Street
Ludington, MI 49431

Customer Service:
Phone: 888-712-8582
goorders@greatopenings.com

www.greatopenings.com
Printed Literature: www.goliterature.com

QUICK REFERENCE FOR ORDERING

All drawer fronts are not available on all products. For restrictions see the individual product pages.



A: Full Pull



B: S-9000 Pull



D: Radiused, Recessed Pull

D: and F: Recessed Pull Colors:
 0256 Black Umber
 0257 Light Grey
 0004 Medium Tone



Q: Square, Satin Nickel Bar Pull



F: Square, Recessed Pull



I: Radiused, HW Pull

Products ordered in any other color will include 0256 Black Umber pulls



S: Square, Satin Nickel Loop Pull
(Add "B" suffix for black pull)



H: Square, HW Pull



N: Radiused, Satin Nickel Loop Pull
(Add "B" suffix for black pull)



P: Square, P Pull

P: Square Front "P" Pull Colors:
 0159 Beige
 0006 Charcoal
 0547 Graphite
 0131 Smoke
 Products ordered in any other color will include 0006 Charcoal pulls

PAINT FINISHES

Great Openings Standard Colors

Allsteel		Haworth	
0217	Brilliant White	0159	Beige
01A7	Champagne Metallic	0228	Cement Textured
0073	Cloud	0141	Chalk
0232	Driftwood	0006	Charcoal
0231	Flint	0547	Graphite
0536	Loft	0205	Greytone
0683	Muslin	0229	Grout Textured
0345	Parchment	0112	Putty
0166	Platinum Metallic	02Y9	Silver Metallic
0239	Fossil	0131	Smoke

Herman Miller		Knoll	
0256	Black Umber	0968	Beige Mist Metallic
0257	Light Grey	0222	Bright White Smooth
0004	Medium Tone	0223	Bright White Textured
0001	Dark Tone	02Y7	Brown
0744	Metallic Champagne	0623	Folkstone Grey
0666	Silver Metallic	0188	Medium Grey
02L6	Soft White	02Y6	Medium Metallic Grey
0784	Warm Grey Neutral	0756	Sandstone
0348	Innertone Light	02X9	Silver Metallic
		0030	Soft Grey

Steelcase		Teknion	
0995	Arctic White Textured	02M0	Arctic Textured
0668	Black Textured	02X5	Espresso Textured
0044	Black	02M3	Granite
0998	Carbon Metallic Textured	02A3	Grey
0678	Fieldstone Textured	02U2	Latte Textured
0722	Midnight Textured	02M2	Nevada
02A4	Milk	02X7	Platinum Metallic
0666	Platinum Metallic	0220	Satin Black
0705	Sterling Metallic	02X4	Silver Textured
0280	Warm White	02N0	Storm White Textured

Dwelling Color Palette			
03Q9	Special Gray	03Q4	Jonquil
03Q7	Bracing Blue	03P8	Garden Sage
03Q8	Honest Blue	03Q5	Emberglow
03Q0	Retreat	03Q3	Chamois
03Q1	Riverway	03Q6	Brandywine
03P9	Independent Gold	03Q2	Antique Red

LAMINATES

GO Part #	HPL Laminate	Brand Code
DWDW	Designer White	Wilsonart D354-60 HPL
BKBK	Black	Wilsonart 1595-60 HPL
FGFG	Fashion Grey	Wilsonart 381-60 HPL
SGSG	Shadow	Wilsonart D96-60 HPL
DMGH	Slate Grey	Wilsonart D91-60 HPL
DZDZ	Desert Zephyr	Wilsonart 4841-60 HPL
SLSL	Steel Mesh	Wilsonart 4879-38 HPL
GYGY	Grey Mesh	Wilsonart 4877-38 HPL
B4B4	Bleached Legno	Formica 8845-58 HPL
NNNN	Neutral Twill	Formica 8826-58 HPL
S8S8	Sarum Twill	Formica 8827-58 HPL
BGBG	Brighton Walnut	Wilsonart 7922K-07 HPL
RHRH	River Cherry	Wilsonart 7937-38 HPL
BCBC	Biltmore Cherry	Wilsonart 7924K-07 HPL
WCWC	Wild Cherry	Wilsonart 7054-60 HPL
KMKM	Kensington Maple	Wilsonart 10776-60 HPL

GO Part #	TFL Laminate	Code
M-1573-60	Frosty White	Wilsonart M-1573-60
M-BKBK	Black	Wilsonart M-1595-60
M-FGFG	Fashion Grey	Wilsonart M-381-60
M-WCWC	Wild Cherry	Wilsonart M-7054-60
M-KMKM	Kensington Maple	Wilsonart M-10776-60

C.F. STINSON FABRICS

GO Part #	Fabric	C.F. Stinson
7A	Black	NH333 - New Hempstead
8Q	Azure	NH359 - New Hempstead
7C	Nickel	NH361 - New Hempstead
7J	Steel	NH366 - New Hempstead
7K	Navy	NH369 - New Hempstead
8R	Red Red Wine	NH389 - New Hempstead
7B	Grey	NH395 - New Hempstead
7G	Fire	NH406 - New Hempstead
D1	Aubergine	NH419 - New Hempstead
7D	Jodhpurs	NH420 - New Hempstead
8M	Cocoa	NH424 - New Hempstead
8P	Zen	NH425 - New Hempstead
8S	Brick	NH434 - New Hempstead
8L	Galaxy	NH509 - New Hempstead

METAL COLORS

All Great Openings products are finished with a hybrid powder formula (epoxy and polyester), which ensures an exceptionally durable, consistent finish. Simply select from our 72 Standard Colors, Industry Favorites (viewed online), or Custom Colors.

72 STANDARD COLORS

All at standard lead times and price, standard colors are smooth, except those identified as textured.

Allsteel	Steelcase	Knoll	Dwelling Color Palette
0217 Brilliant White	0995 Arctic White Textured	0968 Beige Mist Metallic	03Q9 Special Gray
01A7 Champagne Metallic	0668 Black Textured	02Z2 Bright White Smooth	03Q7 Bracing Blue
0073 Cloud	0044 Black	02Z3 Bright White Textured	03Q8 Honest Blue
0232 Driftwood	0998 Carbon Metallic Textured	02Y7 Brown	03Q0 Retreat
0231 Flint	0678 Fieldstone Textured	0623 Folkstone Grey	03Q1 Riverway
0536 Loft	0722 Midnight Textured	0188 Medium Grey	03P9 Independent Gold
0683 Muslin	02A4 Milk	02Y6 Medium Metallic Grey	03Q4 Jonquil
0345 Parchment	0666 Platinum Metallic	0756 Sandstone	03P8 Garden Sage
0166 Platinum Metallic	0705 Sterling Metallic	02X9 Silver Metallic	03Q5 Emberglow
0239 Fossil	0280 Warm White	0030 Soft Grey	03Q3 Chamois
			03Q6 Brandywine
			03Q2 Antique Red
Herman Miller	Haworth	Teknion	
0256 Black Umber	0159 Beige	02M0 Arctic Textured	
0257 Light Grey	02Z8 Cement Textured	02X5 Espresso Textured	
0004 Medium Tone	0141 Chalk	02M3 Granite	
0001 Dark Tone	0006 Charcoal	02A3 Grey	
0744 Metallic Champagne	0547 Graphite	02U2 Latte Textured	
0666 Silver Metallic	0205 Greystone	02M2 Nevada	
02L6 Soft White	02Z9 Grout Textured	02X7 Platinum Metallic	
0784 Warm Grey Neutral	0112 Putty	02Z0 Satin Black	
0348 Innertone Light	02Y9 Silver Metallic	02X4 Silver Textured	
	0131 Smoke	02N0 Storm White Textured	

INDUSTRY FAVORITES (VIEWED ONLINE)

Visit www.greatopenings.com to find a comprehensive list of colors that are available for you to order just as though they were among our 72 Standard Colors.

- No added cost
- Standard lead-time
- No minimum order size
- Not necessary to exchange paint chip samples or to get your signed approval, as we already know we have a good match with the original manufacturer's color
- Simply send us your purchase order with the paint color name and number identified in this on-line list

- Great Openings will process your order, then send you an order acknowledgment
- Depending on paint cost and availability that is beyond our control, colors may be added or removed from this list of Industry Favorites

Please understand that color match is not a perfect science. While Great Openings uses the most sophisticated powder formula color match technology available, our greatest challenge remains the fact that the major manufacturers' colors tend to "drift" over time. Bright whites and silver metallics, in particular, are a challenge to match. For all practical purposes, in common artificial light as well as natural light, Great Openings' Industry Favorites will be an excellent match for our competitors' colors.

CUSTOM COLORS

When you need a color that's not included in our 72 Standard Colors or Industry Favorites, simply send us a paint chip and we'll get it matched. A special lead time or cost will likely be included, but we can almost certainly supply exactly the color you need.

- No minimum order size on Custom Colors
- Custom Color up-charge is applied on a per unit basis
- Minimum lead-time is 15 working days after we receive your written color approval
- We must receive a purchase order before exchanging custom color samples.

Here's how it works for custom colors:

1. Along with your purchase order, send us a 2" X 2" sample of your desired Custom Color (a metal chip is best, but often a laminate or paper sample will work).
2. We'll work with our paint suppliers to find a match, a process that typically takes 10 to 15 business days. Then we'll send a metal sample of our recommended paint color back to you, along with a sign-off sheet, total net up-charge, and lead-time requirements.
3. You'll return the sign-off sheet, we'll send you an order acknowledgment, and away we go!

Check our website for Custom Color Idea Starters, a sampling of trending new custom colors!

Two-tone cabinets, with fronts painted a different color than the cabinet are available. Contact Sales for a quote.

Please note: Our objective is to order exactly the correct amount of paint for each order so that we can offer you the lowest possible price. For this reason, if you happen to order the same custom color again weeks, months, or years later, paint inventory will likely not exist and any additional costs will once again be charged per unit, no matter the order size.

Great Openings Laminate Program

Great Openings offers the laminates listed below, at a standard price and lead time. We also make it easy to order other laminates and edge bands, as described below as "Special Laminates". For memo samples, please go to wilsonart.com or formica.com.

GO Part #	HPL Laminate	Brand Code
DWDW	Designer White	Wilsonart D354-60 HPL
BK BK	Black	Wilsonart 1595-60 HPL
FGFG	Fashion Grey	Wilsonart 381-60 HPL
SGSG	Shadow	Wilsonart D96-60 HPL
DMGH	Slate Grey	Wilsonart D91-60 HPL
DZDZ	Desert Zephyr	Wilsonart 4841-60 HPL
SLSL	Steel Mesh	Wilsonart 4879-38 HPL
GYGY	Grey Mesh	Wilsonart 4877-38 HPL
B4B4	Bleached Legno	Formica 8845-58 HPL
NNNN	Neutral Twill	Formica 8826-58 HPL
S8S8	Sarum Twill	Formica 8827-58 HPL
BGBG	Brighton Walnut	Wilsonart 7922K-07 HPL
RHRH	River Cherry	Wilsonart 7937-38 HPL
BCBC	Biltmore Cherry	Wilsonart 7924K-07 HPL
WCWC	Wild Cherry	Wilsonart 7054-60 HPL
KMKM	Kensington Maple	Wilsonart 10776-60 HPL

GO Part #	TFL Laminate	Code
M-1573-60	Frosty White	Wilsonart M-1573-60
M-BK BK	Black	Wilsonart M-1595-60
M-FGFG	Fashion Grey	Wilsonart M-381-60
M-WCWC	Wild Cherry	Wilsonart M-7054-60
M-KMKM	Kensington Maple	Wilsonart M-10776-60

Special Laminates

When you need a laminate or edge band that's not included in our Standard Laminates & Edges, call Great Openings to request a special quote and lead-time. We have access to WilsonArt®, Formica®, Nevamar®, Pionite® and many more.

Please note that special laminates or edges will require additional charges, lead-time, and minimum order quantities.

When it's time to place your custom laminate order, include the following information on your PO:

- name of your laminate and edge
- manufacturer names
- pattern names
- identification numbers

Special laminates and edges cannot be changed or canceled after the order has been confirmed by our Customer Service Department and an order acknowledgment has been sent.

Standard Work Surface Specifications

Specifications for (HPL) high pressure laminate work surfaces, cabinet tops, and drawer fronts

- Industrial grade particleboard, single-sided decorative laminate overlay
- High performance, high pressure laminate backer
- California Air Regulation Board Compliant to Phase 2. FSC Controlled Wood Status
- Water based, formaldehyde free, GREENGUARD® certified adhesive
- Finished thickness of horizontal application work surfaces is 1.2"
- Finished thickness of vertical application drawer fronts and doors is .8"
- Edge bands are 2mm or 3mm
- Cayenne laminate tops are 5/8" thick

Specifications for (HPL) high pressure laminate doors



- Identical to the specification shown above, except doors feature two-sided decorative high pressure laminate, so the appearance is identical inside and out

Specifications for (TFL) thermal fused laminates for drawer fronts and doors

- TFL is a cost effective, durable product used on vertical services such as drawer fronts and doors
- TFL offers the same abrasion resistance as High Pressure Laminate and slightly less impact resistance, therefore it's appropriate for use on drawer fronts and doors. Thermal Fused Laminates do not meet NEMA specification requirements, scratch resistance, or ball drop tests
- Doors feature two-sided decorative TFL, so the appearance is identical inside and out
- California Air Regulation Board Compliant to Phase 2. FSC Controlled Wood Status
- Finished thickness of TFL drawer fronts and doors is .75"
- Edge bands are 2mm or 3mm (identical to those used on HPL fronts)

Products Available with Laminate Fronts

Any of the following Great Openings cabinets may be special-ordered to include factory-installed laminate fronts. Laminates may be one of Great Openings' standards, or a special ordered laminate. Laminate wood grain is positioned vertically on all fronts, including tower doors. Laminate fronts must be specified to include any one of our loop pulls. UM Series locks are included as standard. When ordering more than 50 of any single laminate size, please call Sales for a quote.

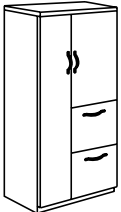
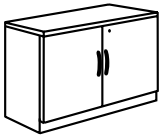
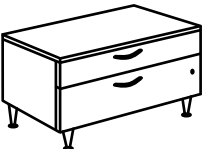
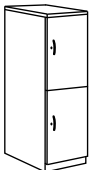
	Notes	Product
	<p>Pedestal drawer fronts and lock strip will be laminate. Cushion pedestals will not include a loop pull on the lock strip. Not available on 3" pencil drawers.</p>	<p>box/file pedestal file/file pedestal box/box/file pedestal</p>
	<p>Lateral drawer fronts and lock strip will be laminate. The lateral top and base are both visible from the front of the cabinet, and will be metal.</p>	<p>Box/file lateral (any width) 2-high lateral (any width) 3-high lateral (any width) 4-high lateral (any width) 5-high lateral (any width) 6-high lateral (any width)</p>
	<p>Laminate drawer and door fronts are full-width. The tower top and base are both visible from the front of the cabinet, and will be metal.</p>	<p>Cupboard wardrobe tower (any height)</p>
	<p>Double door storage fronts are full-width. The cabinet top and base are both visible from the front of the cabinet, and will be metal.</p>	<p>2-high storage cabinet (any width) 3-high double door cabinet (any width)</p>
	<p>Cayenne drawer fronts are full width, and the lock is located in the bottom drawer.</p>	<p>Cayenne two drawer cabinet (any width)</p>
	<p>In the locker section of this pricebook, you'll find laminate front options already priced, as an alternative to metal fronts.</p>	

FABRICS

Fabrics

Great Openings has graded programs with C.F. Stinson and Maharam, and fabric swatches may be ordered directly from them. Please check greatopenings.com for our current fabrics and grades.

For your convenience, we display fifteen C.F. Stinson New Hempstead fabrics in our finish card and price book, just to make it simple to pick a low texture, solid color, 100% polyester fabric. All of these "standard" fabrics are priced at GRADE 1.

GO Part #	Fabric	C.F. Stinson
7A	Black	NH333 - New Hempstead
8Q	Azure	NH359 - New Hempstead
7C	Nickel	NH361 - New Hempstead
7J	Steel	NH366 - New Hempstead
7K	Navy	NH369 - New Hempstead
8R	Red Red Wine	NH389 - New Hempstead
7B	Grey	NH395 - New Hempstead
7G	Fire	NH406 - New Hempstead
D1	Aubergine	NH419 - New Hempstead
7D	Jodhpurs	NH420 - New Hempstead
8M	Cocoa	NH424 - New Hempstead
8P	Zen	NH425 - New Hempstead
8S	Brick	NH434 - New Hempstead
8L	Galaxy	NH509 - New Hempstead

For memo samples, contact C.F. Stinson at 800-841-6279 or see www.cfstinson.com.

Fabric Specifications

- Contents..... 100% polyester
- Finish..... Soil and stain protective finish
- Abrasion Resistance (astm d-4157) Exceeds 100,000 (Bryant Park), and 800,000
(New Hempstead) double rubs (heavy duty Wyzenbeek Method)
- Color Fastness - Light (aatcc-16)..... 40 hours class 4 minutes (New Hempstead), and 5 minutes (Bryant Park)
- Crocking (aatcc-8) (dry) class 4.5 minutes (wet) class 4.5 minutes
- Flammability:
 - Calif. 191-53 Tech. Bulletin 117, Section E..... Passes
 - UFAC and BIFMA Class 1
- Cleaning (w-s)..... Professional service is recommended or use water-based agents

Unless otherwise specified, the fabric grain on all cushions will be applied "front-to-back" as shown below.

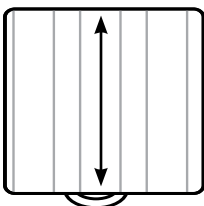

Pedestal

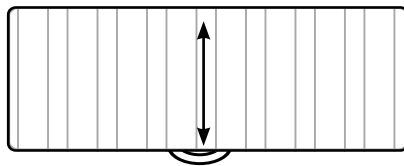

Laterals & FileCenters

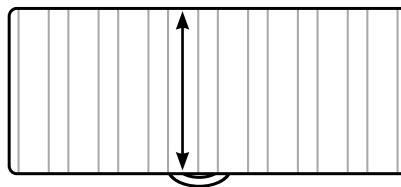

Cayenne Low Storage

FABRICS

How to specify COM fabric on your purchase order:





Calculate the yards of fabric needed using the chart below. If ordering more than 20 identical units, call for fabric requirements

Clearly label your fabric package with:

- Purchase order #
- Dealer name
- Fabric description
- Yardage quantity enclosed

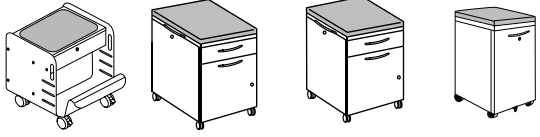

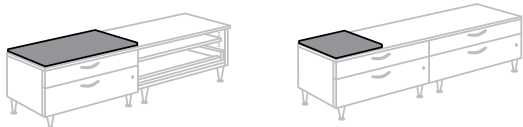
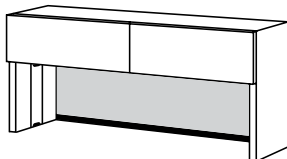



Send the fabric to:

Great Openings (Fabric), 901 East Sixth St., Ludington, MI 49431
 Please note PO or Sales order

Product	Required Yardage
 <p>Cushion FileCenter Cushion Pedestal Molly</p>	Required for 54" or 66" fabric 1 linear yard per unit
 <p>Bill Chester Lester Slim</p>	Required for 54" or 66" fabric Bill (3/4 linear yard per unit) Chester (1 linear yard per unit) Lester (3/4 linear yard per unit) Slim (3/4 linear yard per unit)
 <p>Trace Box/File Lateral Cushions</p>	Required for 54" or 66" fabric • 30", 36", and 42" wide laterals (3/4 linear yard)
 <p>Cayenne Cushion</p>	Required for 54" or 66" fabric 12" wide cushion (3/4 linear yard) 18" wide cushion (3/4 linear yard) 30" wide cushion (3/4 linear yard) 36" wide cushion (3/4 linear yards) 42" wide cushion (3/4 linear yards)
 <p>Desk Hutch</p>	Required for 54" or 66" fabric • 36" wide tack board requires 42" fabric (1-1/2 linear yard) • 42" wide tack board requires 48" fabric (1-1/2 linear yards) • 48" wide tack board requires 54" fabric (1-1/2 linear yards) • 54" wide tack board requires 66" fabric (2 linear yards) • 60" wide tack board requires 66" fabric (2 linear yards) • 66" wide tack board requires 72" fabric (2 linear yards) • 72" wide tack board requires 77" fabric (2-1/2 linear yards)
 <p>Rectangle Screen Scalloped-Shaped Screen</p>	Required for 54" or 66" fabric • 23" wide screen requires 29" fabric (1 linear yard) • 29" wide screen requires 35" fabric (1 linear yard) • 35" wide screen requires 41" fabric (1-1/2 linear yards) • 41" wide screen requires 47" fabric (1-1/2 linear yards) • 47" wide screen requires 53" fabric (1-1/2 linear yards) • 59" wide screen requires 65" fabric (2 linear yards) • 65" wide screen requires 71" fabric (2 linear yards) • 71" wide screen requires 77" fabric (2-1/2 linear yards)

The scalloped-shaped screens require the same amount of fabric as the rectangular screens. The 20-3/4" and 12" screen height dimension will be taken from the width of the cloth.

KEYED LOCKS

	UM (G) (our standard lock)	LL (Z)	SL (H)	ML (H)	HW (Z)	K (G)
						
	Black Patent	Satin Nickel, Scalloped	Grey Scalloped	Grey Scalloped	Satin Nickel, Scalloped	Black Patent
Compatible with which other Manufacturers?	Herman Miller	None	Haworth SL (Not Available on Chester or Lester)	Haworth ML (Not Available on Chester or Lester)	Haworth HW	Knoll Series
Interchangeable with other manufacturers' locks?	Interchangeable key and core	N/A	Interchangeable key and core	Interchangeable key and core	N/A	You cannot interchange K Series cores between Great Openings and Knoll products, but our "K" keys will operate Knoll's "K" locks, and vice versa
Description	As standard, all GO products are shipped with a randomly-assigned UM lock, which is black, master-keyed, and core removable	The LL lock is master-keyed and core removable	There is no master-key available for SL locks	Great Openings does not offer the Haworth ML series lock, but Haworth's ML lock cores will operate in our SL Lock mechanism Order the SL lock and then replace the cores and keys with ML in the field. It is the dealer's responsibility to source and provide the ML cores and keys	Great Openings does not offer the Haworth HW series lock, but Haworth's HW lock cores will operate in our LL Lock mechanism Order the LL lock and then replace the cores and keys with HW in the field. It is the dealer's responsibility to source and provide the HW cores and keys	Our K Series cores and keys will operate the Knoll K Series locks Order the UM Series lock and then replace the cores and keys with K Series in the field We support a key range of K-001 through K-100; should you require numbers K-101 through K-250, please contact Customer Service
How to order	No special instructions are needed No extra charge	You must clearly specify "LL Series Locks" on your purchase order No extra charge	You must clearly specify "Haworth SL Series Locks" on your purchase order No extra charge	You must clearly specify "Haworth SL Series Locks" on your purchase order No extra charge	You must clearly specify "LL Series Locks" on your purchase order No extra charge	When ordering the product, no need for special ordering instructions; GO products ship as standard with UM locks You must also order K Series cores and keys separately, either random or with specified key codes No extra charge
Key # range	226 to 425 (408 & 412 not available)	226 to 325	1 to 300	N/A	N/A	1 to 250
When shipped....	UM core and key are randomly assigned	LL core and key are randomly assigned	SL core and key are randomly assigned	SL core and key are randomly assigned	LL core and key are randomly assigned	Products are shipped with UM Series lock housing, cores and keys
Key alike service available? (cores and keys will ship separately)	Yes, no charge Specify the desired key sequence on your PO, or specify "random"	Yes, no charge Specify the desired key sequence on your PO, or specify "random"	Yes, no charge Specify the desired key sequence on your PO, or specify "random"	No	No	Yes, no charge Specify the desired key sequence on your PO, or specify "random"
At installation....	No extra steps are needed	No extra steps are needed	No extra steps are needed	Remove and dispose of the SL cores and keys, then replace with ML cores and keys	Remove and dispose of the LL cores and keys, then replace with HW cores and keys	Remove and dispose of the UM Series cores and keys, then replace with K Series cores and keys

Key-Alike Order Form



Type or write in your requests. If you have typed in the form, save and email as an attachment to goorders@greatopenings.com. If you have filled out form by hand, please scan and email.

Date _____ Order Entry # _____
 PO# _____ Notes _____

CUSTOMER INFORMATION

Company _____
 Contact Name _____
 Address _____
 City _____ State _____ Zip _____

SHIPPING INFORMATION

Company _____
 Address _____
 City _____ State _____ Zip _____

CORE KEY UM LL Knoll SL Quantity _____

KEYED ALIKE

_____ Sets of _____ keyed alike	_____ Sets of _____ keyed alike
_____ Sets of _____ keyed alike	_____ Sets of _____ keyed alike
_____ Sets of _____ keyed alike	_____ Sets of _____ keyed alike
_____ Sets of _____ keyed alike	_____ Sets of _____ keyed alike
_____ Sets of _____ keyed alike	_____ Sets of _____ keyed alike

Key-Alike Process and Charges:

- Your key-alike request can be ordered on the original purchase order or under separate cover.
- Key-alike requests for the UM, SL, LL and K Series locks are processed at no charge as long as the quantity of key/core sets match the quantity of cabinets.
- When including the UM, SL, and LL Series locks, products will be shipped with randomly assigned cores/keys. Your key-alike requests for all lock series will be shipped separately and labeled to allow for easy change-out in the field, after the product is installed.
- A core-removal key is provided at no charge with each key-alike request.
- Additional keys, cores, master keys, and core keys may be purchased separately. The cost is \$4 net per item, plus \$15 net for shipping costs.

When ordering products to be keyed-alike, include this Key Order Form with your purchase order. An electronic version of this form can be found at greatopenings.com under "Resources".

TAGGED AND LABELED KEY SETS

Line	Type	Core Number	Quantity	Tagging Information
1				
2				
3				
4				
5				
6				
7				
8				
9				
10				
11				
12				
13				
14				
15				

This guide provides specific information to keep your Great Openings and Sparkeology products like new. With proper care, you can expect years of trouble-free use.

Cleaning Painted Metal

1. Apply a small amount of nonabrasive cleaner such as Simple Green®, Windex®, or 409®, using a paper towel or a clean, dry, lint-free microfiber cloth.
2. Rub gently to remove dirt.
3. Wipe clean using a new paper towel or cloth.

Cleaning Laminate

1. Apply a vinegar-and-water solution to a paper towel or a clean, lint-free microfiber cloth.
2. Gently wipe the surface to remove any surface dust. **Caution:** do not use furniture polish that contains waxes and oils on laminate surfaces. Do not use bleached-based cleaners on laminate as it may discolor. Do not use hard bristle brushes that may scratch the surface.
3. To spot clean laminate, use a mild soap-and-water solution or Windex®.
4. Rub the soiled area in the direction of the grain. If no grain is present, rub in a circular motion.

Cleaning Fabric

1. Regularly clean your fabric by vacuuming or light brushing.
2. Always check the fabric-specific cleaning instructions before deciding which cleaning product to use.
3. Test the cleaning product in an inconspicuous area first to guard against color bleeding or fabric shrinkage.

Cleaning Acrylic Screens and Resin Tops

1. Use mild soap-and-water, applied with a dry lint-free cloth.
2. Wipe clean to remove soap and moisture residue.

PERSONAL STORAGE AND TRACE PEDESTAL SPECIFICATIONS



Basic Construction

- All Great Openings products meet or exceed applicable ANSI-BIFMA standards for durability and safety
- Welded steel frame construction and formed channels ensure strength in key areas
- Top and side channels are 18-21 gauge cold rolled steel
- Outer panels and drawer bins are 22 gauge steel, drawer fronts are 20 gauge steel
- Weight limits of 200 lbs for mobile pedestals and cushion mobile storage
- Black plastic casters are 37 mm, 2 locking and 2 non-locking, installed in the field
- Translucent casters are 50mm, all four casters are non-locking, installed in the field
- Cabinet heights listed include black plastic 37mm casters
- Four leveling glides with 1-5/8" adjustment ensure proper alignment and operation
- Leveling glides are not interchangeable with casters
- The front-facing kick plate on Trace freestanding pedestals is 3.25" high

Features

- Drawer fronts are mechanically fastened and removable to maximize design flexibility
- All drawers include full extension, steel ball bearing slides
- Slides include anti-rebound and quick disconnect features
- Drawer fronts include rubber bumpers for quiet operation
- Drawers can accommodate letter, legal, and ledger filing. Legal and ledger filing require a file drawer divider, sold separately

Options and Accessories

- All options and accessories are sold separately or are available as an upgrade
- Box drawer dividers snap into position and remain in place
- File drawer dividers snap into position to accommodate side-to-side filing
- Pencil trays include four compartments and sit on top of the sides of the box or file drawer bin
- Laminate drawer fronts may be specified. See the Specification Guide for details
- Polyethylene drawer front fillers increase sound absorption
- Individually locking drawers, either keyed or electronic

Lock System

- All Great Openings products include randomly-assigned UM Series locks
- UM locks are black-faced, master-keyed, and core-removable
- Locks may be keyed-alike in the field
- Other key series are available, including Haworth SL, bright nickel LL, and Knoll K. See the Specification Guide for details and how to order
- Pedestals may be ordered to include individually locking security drawers. See the Pedestal Accessory section for details

Counterweights

- Mobile Pedestals, Freestanding Pedestals, and Mobile FileCenters include factory installed counterweight
- Counterweights are not necessary for work surface supporting pedestals or hanging pedestals

Load Capacity

- Pencil drawer: 50 lbs
- Box drawer: 50 lbs
- File drawer: 70 lbs
- Chester, Lester, and Slim bottom drawers: 70 lbs

Trace Pedestal File Inside Dimensions (in inches)

	Inner Height	Inner Width	Inner Depth
Pedestal 17-7/8" deep			
pencil drawer	1.75"	12.125"	15.2"
box drawer	4.5"	12.125"	15.2"
file drawer	9.5"	12.125"	15.2"
Pedestal 18-7/8" deep			
pencil drawer	1.75"	12.125"	15.2"
box drawer	4.5"	12.125"	15.2"
file drawer	9.5"	12.125"	15.2"
Pedestal 21-7/8" deep			
pencil drawer	1.75"	12.125"	18.25"
box drawer	4.5"	12.125"	18.25"
file drawer	9.5"	12.125"	18.25"
Pedestal 27-7/8" deep			
pencil drawer	1.75"	12.125"	24.25"
box drawer	4.5"	12.125"	24.25"
file drawer	9.5"	12.125"	24.25"
Slim			
concealed drawer	1.75"	9.5"	15.2"
bottom drawer	11.0"	9.75"	15.2"
Chester			
top compartment	3.75"	13.8"	15.0"
backpack well	18.5"	13.8"	6.0"
concealed top drawer	1.75"	12.8"	15.8"
bottom drawer	11.0"	12.125"	15.6"
Lester			
top compartment	3.75"	13.8"	15.0"
concealed top drawer	1.75"	12.8"	15.8"
bottom drawer	11.0"	12.125"	15.6"
Molly			
box drawer	4.5"	12.125"	15.2"
file drawer	9.5"	12.125"	15.2"
open shelf/cupboard	17.2"	13.8"	17.3"
Mobile FileCenter			
box drawer	4.5"	12.125"	15.2"
file drawer	9.5"	12.125"	15.2"
Personal Drawer			
personal drawer	2.0"	18.0"	12.2"

Bill



- 12 gauge powder coated steel shell
- 75mm gray casters, 2 locking and 2 non-locking
- Optional top cushion attached to metal top with dual-lock strips, standard fabrics plus C.O.M. program. Linear yardage required for COM fabric (20 units or fewer) - 3/4 yard -unless otherwise specified, the fabric grain on cushions will be applied "front-to-back"
- Open front bin for backpacks and bags
- Laminate storage interior
- Rear bin storage with hanging file compatibility
- Ergonomic footrest with non-skid protective strip
- Soft closing lid
- Lockable – compatible with Cayenne and Trace
- Locks may be keyed-alike in the field

Description	H	D	W	Pkg Wt	Pkg Cube	Part #	Metal Color	Laminate		List Price	GR 1 Price	GR 2 Price	GR 3 Price	GR 4 Price	GR 5 Price	COM Price
								M-1573-60 Frosty White	M-631-60-Classic Black							
Bill 18" width	19	21	18	51 lb	5.6 ft	BG1818	?		?	\$1,090	-	-	-	-	-	-
Bill 24" width	19	21	24	62 lb	7.5 ft	BG1824	?		?	\$1,090	-	z	-	-	-	-
Cushion 18" width	3/4	19	16	na	na	APLX18	-				\$170	\$247	\$278	\$308	\$323	\$165
Cushion 24" width	3/4	19	20	na	na	APLX24	-				\$190	\$267	\$298	\$328	\$342	\$185

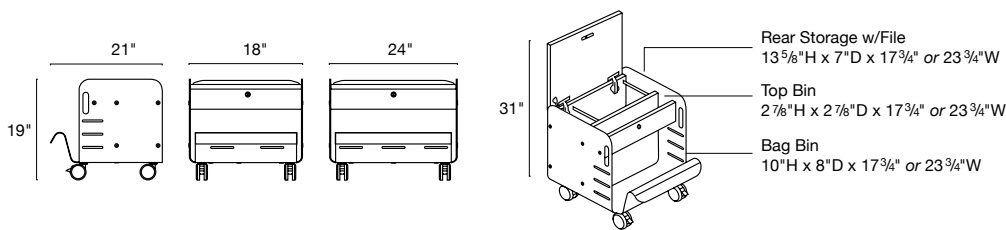

Marty

Not available on GSA schedule

- All Great Openings products meet or exceed applicable ANSI-BIFMA standards for durability and safety
- 14 gauge steel frame and 12 gauge steel door, available in 72 standard colors plus custom powder coated finishes
- Laminate shelf (TFL) in white, grey or black
- Detachable hook for hanging bags
- Optional wireless charging disc in silver metallic with 5 foot cord
- Marty's touch-latch door is available non-locking for easy access or with UM series lock for added security
- Electronic, SL and ML lock series not available

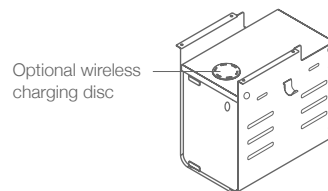
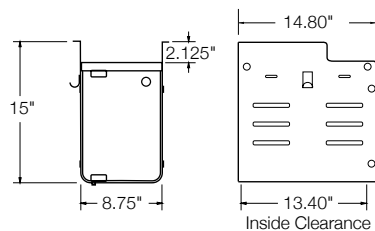

Wireless charger option on hold until further notice.

Description	H	D	W	Pkg Wt	Pkg Cube	Part #	Metal Color	Laminate		List Price
								M-1573-60 Frosty White	M-631-60-Classic Black	
Marty Right Hinge	15"	14.80"	8.75"	22 Lb	2.5	HAN1513RH	?		?	\$525
Marty Right Hinge With Power	15"	14.80"	8.75"	22 Lb	2.5	HQI1513RH	?		?	\$650
Marty Left Hinge	15"	14.80"	8.75"	22 Lb	2.5	HAN1513LH	?		?	\$525
Marty Left Hinge With Power	15"	14.80"	8.75"	22 Lb	2.5	HQI1513LH	?		?	\$650
Marty Right Hinge, Locking	15"	14.80"	8.75"	22 Lb	2.5	HNU1513RH	?		?	\$600
Marty Right Hinge With Power, Locking	15"	14.80"	8.75"	22 Lb	2.5	HQU1513RH	?		?	\$725
Marty Left Hinge, Locking	15"	14.80"	8.75"	22 Lb	2.5	HNU1513LH	?		?	\$600
Marty Left Hinge With Power, Locking	15"	14.80"	8.75"	22 Lb	2.5	HQU1513LH	?		?	\$725

Odie

- 14 gauge steel frame and 12 gauge steel door, available in 72 standard colors and custom powder coat finishes
- Laminate interior shelf, back and fascia, available in white, grey or black
- Dual Durometer 75mm black/grey locking casters (2L/2NL) integrated into outrigger base for stability
- Ergonomic, three-stage telescoping handle
- Drawer bin includes self-closing suspension with file bar to accommodate side-to-side letter or legal files
- Detachable hook for hanging bags
- 200 lb weight limit
- UM series, core-removable, master keyed, matte black finish
- Low-profile vinyl pad with wrap-around design and magnetic attachment available in four colors

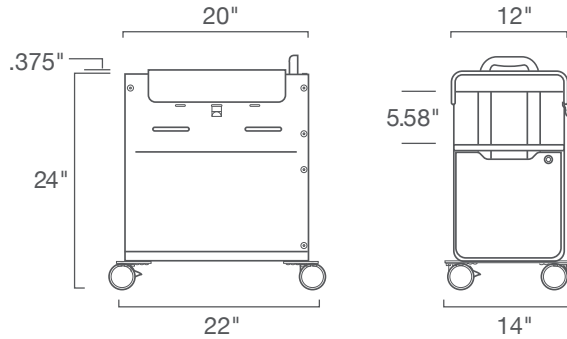

Laminates			Vinyls			
						
M-1573-60 Frosty White	M-631-60 Classic Black	M-D381-60 Grey	STP 60 Raven	STP 66 Mist	STP 65 Smith	STP 67 Fire

Description	H	D	W	Pkg Wt	Pkg Cube	Part #	Metal Color	Laminate M-1573-60 Frosty White M-631-60 Classic Black M-D381-60 Grey	List Price
Odie	24	20	12	62 lb	5.3 ft	LNA-2418	?	?	\$1,195

Description	H	D	W	Pkg Wt	Pkg Cube	Part #	Vinyl STP 60 GR2 Raven STP 66 GR2 Mist STP 65 GR2 Smith STP 67 GR2 Fire	List Price
Magnetic Vinyl Pad	3/8	18	15	na	na	NACX0018XXXXK	?	\$260

Chester



- Available with either a laminate or cushion top
- Linear yardage required for COM fabric (20 units or fewer): Chester - 1 yard
- Unless otherwise specified, the fabric grain on cushions will be applied "front-to-back"; the "front" is the side with drawers
- Includes a soft landing pad on compartment shelf
- A grommet is located in the top back of the cabinet, so that electronics may be securely stored while charging
- A concealed top drawer is accessible when bottom drawer is open
- Hinged top includes gas cylinder pneumatic guide, with easy-down mechanism
- Includes two UM series locks, keyed alike
- Electronic lock is not available
- SL and ML lock series not available
- Metal side bin is sold separately, and fits on either Chester or Lester
- Cushion top includes markerboard finish on underside

H	D	W	Caster Style	Hinge Location	Pkg Wt	Pkg Cube	Part #	Front Part #	Metal Color	Fabric #	Lam/Edge	List Price	GR 1 Price	GR 2 Price	GR 3 Price	GR 4 Price	GR 5 Price	COM Price	
Laminate Top																			
21-7/8	23-1/2	15-1/4	black	left	68 lb	5.9 ft	EGL	?	6565	?	n/a	?	\$1,286						
21-7/8	23-1/2	15-1/4	black	right	68 lb	5.9 ft	EGR	?	6565	?	n/a	?	\$1,286						
Cushion Top (Includes markerboard)																			
22-1/4	23-1/2	15-1/4	black	left	68 lb	5.9 ft	EGL	?	6565	?	?	n/a	\$1,179	\$1,274	\$1,311	\$1,349	\$1,379	\$1,174	
22-1/4	23-1/2	15-1/4	black	right	68 lb	5.9 ft	EGR	?	6565	?	?	n/a	\$1,179	\$1,274	\$1,311	\$1,349	\$1,379	\$1,174	
5-3/4	2-1/2	15	side bin	n/a	5 lb	1.5 ft	MFP	n/a	0065	?	n/a	n/a	\$97						

Available Fronts Q | S

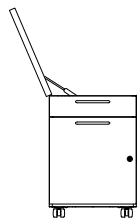

Hinge Left

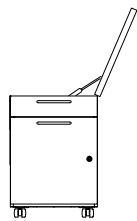

Hinge Right

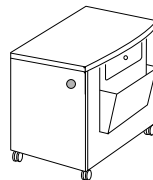

Rear Grommet Location

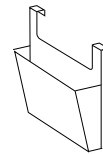

Side Bin

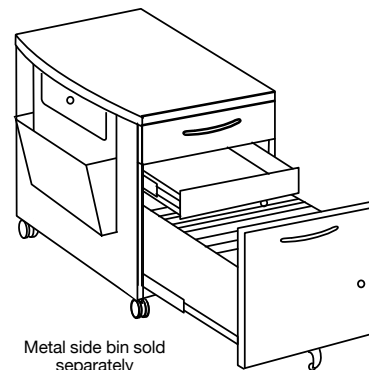
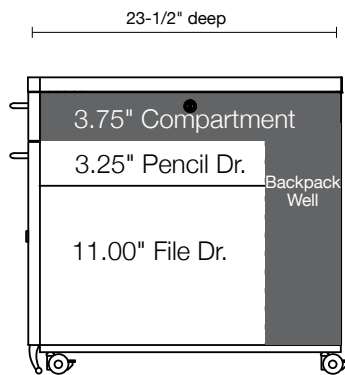
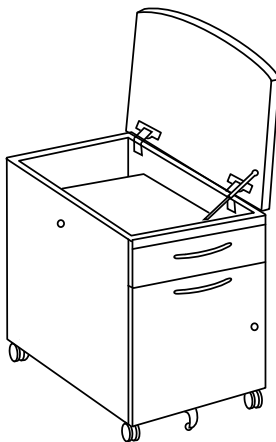

Metal side bin sold separately

Lester



- Available with either a laminate or cushion top
- Linear yardage required for COM fabric (20 units or fewer): Lester - 3/4 yard
- Unless otherwise specified, the fabric grain on cushions will be applied "front-to-back"; the "front" is the side with drawers
- Includes a soft landing pad on compartment shelf
- A grommet is located in the top back of the cabinet, so that electronics may be securely stored while charging
- A concealed top drawer is accessible when bottom drawer is open
- Hinged top includes gas cylinder pneumatic guide, with easy-down mechanism
- Includes two UM series locks, keyed alike
- SL and ML lock series not available
- Electronic lock is not available
- Metal side bin is sold separately, and fits on either Chester or Lester
- Cushion top includes markerboard finish on underside

H	D	W	Caster Style	Hinge Location	Pkg Wt	Pkg Cube	Pkg Part #	Front Part #	Metal Color	Lam/Fabric #	Lam/Edge	List Price	GR 1 Price	GR 2 Price	GR 3 Price	GR 4 Price	GR 5 Price	COM Price	
Laminate Top																			
21-7/8	17-7/8	15-1/4	black	left	68 lb	5.9 ft	EGL	?	7566	?	n/a	?	\$1,233						
21-7/8	17-7/8	15-1/4	black	right	68 lb	5.9 ft	EGR	?	7566	?	n/a	?	\$1,233						
Cushion Top (Includes markerboard)																			
22-1/4	17-7/8	15-1/4	black	left	68 lb	5.9 ft	EGL	?	7566	?	?	n/a	\$1,126	\$1,188	\$1,214	\$1,238	\$1,259	\$1,120	
22-1/4	17-7/8	15-1/4	black	right	68 lb	5.9 ft	EGR	?	7566	?	?	n/a	\$1,126	\$1,188	\$1,214	\$1,238	\$1,259	\$1,120	
5-3/4	2-1/2	15	side bin	n/a	5 lb	1.5 ft	MFP	n/a	0065	?	n/a	n/a	\$97						

Available Fronts | S

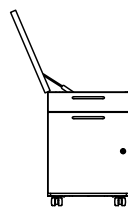

Hinge Left

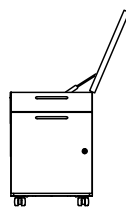

Hinge Right



Rear Grommet Location

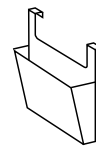

Side Bin

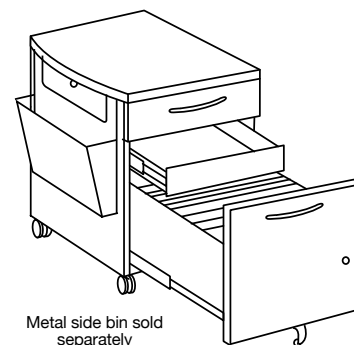
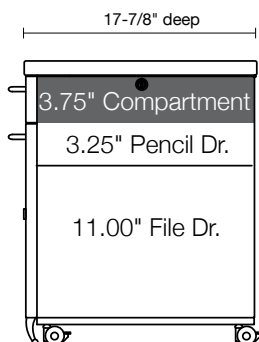
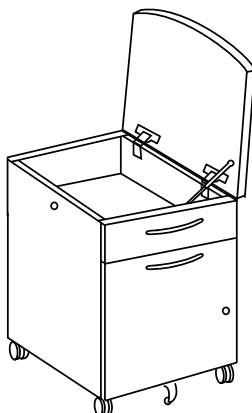

Slim



- Bottom drawer may be specified as single-sided (left or right) or two-sided
- A two-sided drawer includes file bars to accommodate letter or legal hanging files
- A concealed top drawer is accessible when bottom drawer is open
- Cushion is 1" foam, attached to metal top with dual-lock strips
- Linear yardage required for COM fabric (20 units or fewer): Slim - 3/4 yard
- Unless otherwise specified, the fabric grain on cushions will be applied "front-to-back"
- To specify an electronic lock instead of keyed lock, add an "E" after the "U" or "T" of the part number and add \$340 to the list price
- Includes black 37mm casters (2) locking and (2) non-locking
- A 5th caster is located under the bottom drawer
- Caster height allows for 1.792" clearance

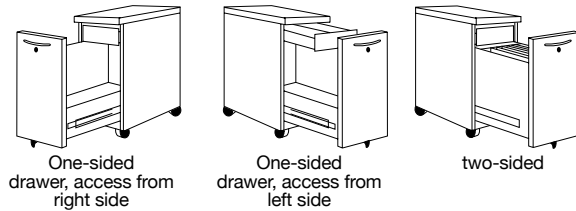

H	D	W	Description	Top Option	Drawer access from side	Pkg Wt	Pkg Cube	Part #	Front	Part #	Metal Color	Fabric #	GR 1 Price	GR 2 Price	GR 3 Price	GR 4 Price	GR 5 Price	COM Price
20	18-7/8	12	one-sided drawer	metal	left	41lb	3.8 ft	SLU	?	5638	?	n/a	\$621	n/a	n/a	n/a	n/a	n/a
20	18-7/8	12	one-sided drawer	metal	right	41 lb	3.8 ft	SRU	?	5638	?	n/a	\$621	n/a	n/a	n/a	n/a	n/a
20	18-7/8	12	two-sided drw. & file bars	metal	n/a	41 lb	3.8 ft	STU	?	5640	?	n/a	\$644	n/a	n/a	n/a	n/a	n/a
21	18-7/8	12	one-sided drawer	cushion	left	49 lb	3.8 ft	SLU	?	5638C	?	?	\$782	\$862	\$894	\$927	\$953	\$777
21	18-7/8	12	one-sided drawer	cushion	right	49 lb	3.8 ft	SRU	?	5638C	?	?	\$782	\$862	\$894	\$927	\$953	\$777
21	18-7/8	12	two-sided drw. & file bars	cushion	n/a	49 lb	3.8 ft	STU	?	5640C	?	?	\$804	\$884	\$916	\$948	\$974	\$799

Available Fronts | A Q | S

Molly



- 1-1/2" cushion is factory-installed with screws
- Linear yardage required for COM fabric (20 units or fewer): Molly - 1 yard
- Unless otherwise specified, the fabric grain on cushions will be applied "front-to-back"
- Box/File drawer may be specified on either left or right side
- Includes either open shelves or hinged door
- Hinges are always oriented on the outside of the cabinet
- Electronic lock is not available
- Includes black 37mm casters (2) locking and (2) non-locking
- A 5th caster is located under the bottom drawer

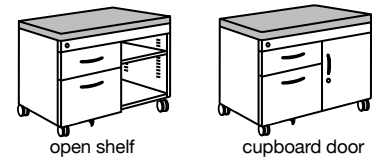

H	D	W	Description	Drawer/ Location	Pkg Wt	Pkg Cube	Part #	Front	Part #	Metal Color	Fabric #	Lam/ Edge #	GR 1 Price	GR 2 Price	GR 3 Price	GR 4 Price	GR 5 Price	COM Price
22-3/8	18-1/4	30-1/2	cup. dr./met. top	left	96.5 lb	12.2 ft	FL	?	L4G 6T	?	n/a	n/a	\$1,278	n/a	n/a	n/a	n/a	n/a
22-3/8	18-1/4	30-1/2	cup. dr./met. top	right	96.5 lb	12.2 ft	FR	?	L4T 9T	?	n/a	n/a	\$1,278	n/a	n/a	n/a	n/a	n/a
22-3/8	18-1/4	30-1/2	open sh./met. top	left	92.5 lb	12.2 ft	FL	?	L4U 2T	?	n/a	n/a	\$1,118	n/a	n/a	n/a	n/a	n/a
22-3/8	18-1/4	30-1/2	open sh./met. top	right	92.5 lb	12.2 ft	FR	?	L4U 1T	?	n/a	n/a	\$1,118	n/a	n/a	n/a	n/a	n/a
22-3/8	18-1/4	30-1/2	cup. dr./lam. top	left	98.5 lb	12.2 ft	FL	?	L4 G6	?	n/a	?	\$1,459	n/a	n/a	n/a	n/a	n/a
22-3/8	18-1/4	30-1/2	cup. dr./lam. top	right	98.5 lb	12.2 ft	FR	?	L4 T9	?	n/a	?	\$1,459	n/a	n/a	n/a	n/a	n/a
22-3/8	18-1/4	30-1/2	open sh./lam. top	left	94.5 lb	12.2 ft	FL	?	L4 U2	?	n/a	?	\$1,373	n/a	n/a	n/a	n/a	n/a
22-3/8	18-1/4	30-1/2	open sh./lam. top	right	94.5 lb	12.2 ft	FR	?	L4 U1	?	n/a	?	\$1,373	n/a	n/a	n/a	n/a	n/a
22-5/8	18-1/4	30-1/2	cup. dr./cushion	left	101.5 lb	12.4 ft	FL	?	L4G 6C	?	?	n/a	\$1,492	\$1,617	\$1,666	\$1,717	\$1,757	\$1,486
22-5/8	18-1/4	30-1/2	cup. dr./cushion	right	101.5 lb	12.4 ft	FR	?	L4T 9C	?	?	n/a	\$1,492	\$1,617	\$1,666	\$1,717	\$1,757	\$1,486
22-5/8	18-1/4	30-1/2	open sh./cushion	left	97.5 lb	12.4 ft	FL	?	L4U 2C	?	?	n/a	\$1,406	\$1,531	\$1,580	\$1,631	\$1,672	\$1,400
22-5/8	18-1/4	30-1/2	open sh./cushion	right	97.5 lb	12.4 ft	FR	?	L4U 1C	?	?	n/a	\$1,406	\$1,531	\$1,580	\$1,631	\$1,672	\$1,400

Available Fronts | A Q | S

TRACE PEDESTALS

SIN 33721

TRACE Mobile FileCenter



- Choose from cushion top or metal top
- 1-1/2" cushion is factory-installed with screws
- Linear yardage required for COM fabric (20 units or fewer): 1 yard
- Unless otherwise specified, the fabric grain on cushions will be applied "front-to-back"
- Black casters are 3.50" in diameter, translucent casters are 2.60" in diameter
- Electronic lock is not available
- Counterweight is included

H	D	W	Description	Caster Style	Pkg Wt	Pkg Cube	Part #	Front	Part #	Metal Color	Fabric #	GR 1 Price	GR 2 Price	GR 3 Price	GR 4 Price	GR 5 Price	COM Price
24-1/4	18-3/8	30-1/2	cushion top	black	120 lb	12.2 ft	FL	?	0108C	?	?	\$1,664	\$1,785	\$1,829	\$2,298	\$2,357	\$1,659
23-3/8	18-3/8	30-1/2	cushion top	trans.	120 lb	12.2 ft	FL	?	0111C	?	?	\$1,786	\$1,907	\$1,951	\$2,420	\$2,479	\$1,781
23-1/4	18-3/8	30-1/2	metal top	black	120 lb	12.2 ft	FL	?	0108T	?	n/a	\$1,461	n/a	n/a	n/a	n/a	n/a
22-3/8	18-3/8	30-1/2	metal top	trans.	120 lb	12.2 ft	FL	?	0111T	?	n/a	\$1,574	n/a	n/a	n/a	n/a	n/a

Available Fronts | A  F | H  P | Q | S

TRACE PEDESTALS

SIN 33721

Spec Guide Personal Storage Pedestals Lateral Lockers Towers Storage Cabinets Bookcases Cayenne Ht Adj Tables Trace Desk Desk Accessories Sparkology Terms/Conds

TRACE Cushion Mobile Pedestal



- 1-1/2" cushion is factory-installed with screws
- 1 linear yard required for COM fabric (20 units or fewer)
- Unless otherwise specified, the fabric grain on cushions will be applied "front-to-back"
- When any loop pull is designated, a matching loop pull is included on the lock strip
- When any non-loop pull is designated, a Satin Nickel loop pull is included on the lock strip
- To specify an electronic lock instead of keyed lock, add an "E" after the "U" or "T" of the part number and add \$340 to the list price
- For COM fabric ordering instructions, see the Specification Guide

H	D	W	Caster style	Drawer Options	Pkg Wt	Pkg Cube	Part #	Front	Part #	Metal Color	Fabric #	Part #	GR 1 Price	GR 2 Price	GR 3 Price	GR 4 Price	GR 5 Price	COM Price
22-5/8	18-7/8	15-1/4	black	box/file	60 lb	5.9 ft	U	?	1403	?	?	N	\$758	\$820	\$846	\$871	\$891	\$753
22-5/8	21-7/8	15-1/4	black	box/file	70 lb	6.6 ft	U	?	1503	?	?	N	\$771	\$833	\$859	\$884	\$904	\$766
23-7/16	18-7/8	15-1/4	translucent	box/file	60 lb	5.9 ft	T	?	1403	?	?	N	\$870	\$932	\$958	\$983	\$1,003	\$865
23-7/16	21-7/8	15-1/4	translucent	box/file	70 lb	6.6 ft	T	?	1503	?	?	N	\$882	\$944	\$970	\$995	\$1,015	\$877
25-1/2	18-7/8	15-1/4	black	pencil/box/file	70 lb	6.1 ft	U	?	1719	?	?	N	\$918	\$980	\$1,006	\$1,031	\$1,051	\$913
25-1/2	21-7/8	15-1/4	black	pencil/box/file	75 lb	6.8 ft	U	?	1819	?	?	N	\$934	\$996	\$1,022	\$1,047	\$1,067	\$929
26-3/8	18-7/8	15-1/4	translucent	pencil/box/file	70 lb	6.1 ft	T	?	1719	?	?	N	\$1,054	\$1,116	\$1,142	\$1,167	\$1,187	\$1,049
26-3/8	21-7/8	15-1/4	translucent	pencil/box/file	75 lb	6.8 ft	T	?	1819	?	?	N	\$1,067	\$1,129	\$1,155	\$1,180	\$1,200	\$1,062

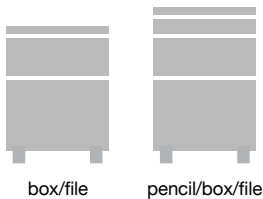

Available Fronts	box and file drawers	A	B	D	F	H	I	N	P	Q	S
	pencil drawers	A	X	X	X	X	X	N	X	Q	S

TRACE PEDESTALS

SIN 33721

TRACE Mobile Pedestal



box/file



pencil/box/file



box/box/file



box/box/box



box/box/box/box



file/file

- To add a Satin Nickel loop pull on the lock strip (as shown on the Cushion Mobile Pedestal), add an "N" as a suffix to the part number and \$48 to the list price
- Mobile pedestals are not to be used as a seat, a cushion may not be added to this mobile pedestal
- To specify an electronic lock instead of keyed lock, substitute an "E" for the second letter "L" of the part number and add \$340 to the list price
- Includes black 37mm casters (2) locking and (2) non-locking

H	D	W	Drawer Options	Pkg Wt	Pkg Cube	Part #	Front	Part #	Metal Color	Price
26-7/8	18-7/8	15-1/4	file/file	60 lb	7.0 ft	EL	?	2009	?	\$594
26-7/8	18-7/8	15-1/4	box/box/file	64 lb	7.0 ft	EL	?	2011	?	\$656
26-7/8	18-7/8	15-1/4	box/box/box/box	60 lb	7.0 ft	EL	?	2010	?	\$689
26-7/8	21-7/8	15-1/4	file/file	68 lb	8.0 ft	EL	?	2109	?	\$602
26-7/8	21-7/8	15-1/4	box/box/file	73 lb	8.0 ft	EL	?	2111	?	\$662
26-7/8	21-7/8	15-1/4	box/box/box/box	68 lb	8.0 ft	EL	?	2110	?	\$708
26-7/8	27-7/8	15-1/4	file/file	79 lb	10.0 ft	EL	?	2209	?	\$671
26-7/8	27-7/8	15-1/4	box/box/file	85 lb	10.0 ft	EL	?	2211	?	\$707
26-7/8	27-7/8	15-1/4	box/box/box/box	79 lb	10.0 ft	EL	?	2210	?	\$740
24	18-7/8	15-1/4	pencil/box/file	73 lb	7.8 ft	EL	?	1719	?	\$715
24	21-7/8	15-1/4	pencil/box/file	73 lb	7.8 ft	EL	?	1819	?	\$741
24	27-7/8	15-1/4	pencil/box/file	73 lb	7.8 ft	EL	?	1919	?	\$757
21-1/8	18-7/8	15-1/4	box/file	54 lb	5.6 ft	EL	?	1403	?	\$544
21-1/8	18-7/8	15-1/4	box/box/box	54 lb	5.6 ft	EL	?	1404	?	\$618
21-1/8	21-7/8	15-1/4	box/file	63 lb	6.3 ft	EL	?	1503	?	\$557
21-1/8	21-7/8	15-1/4	box/box/box	63 lb	6.3 ft	EL	?	1504	?	\$625
21-1/8	27-7/8	15-1/4	box/file	73 lb	7.8 ft	EL	?	1603	?	\$605

Available Fronts	box and file drawers	A	B	D	F	H	I	N	P	Q	S
	pencil drawers	A	B	D	F	H	I	N	P	Q	S

TRACE PEDESTALS

SIN 33721

TRACE Work Surface Supporting Pedestal

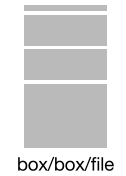
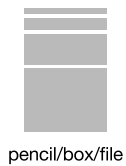

- Top channels are exposed, to attach to underside of work surface
- Special 27" and 24-3/4" heights accommodate low profile work surfaces
- Counterweight not included; a Work Surface Supporting Pedestal cannot be used in a freestanding application
- To specify an electronic lock instead of keyed lock, substitute an "E" for the second letter "L" of the part number and add \$340 to the list price

H	D	W	Drawer Options	Pkg Wt	Pkg Cube	Part #	Front	Part #	Metal Color	Price
27-3/4	17-7/8	15-1/4	file/file	51 lb	7.2 ft	EL	?	2909	?	\$540
27-3/4	17-7/8	15-1/4	box/box/file	53 lb	7.2 ft	EL	?	2911	?	\$586
27-3/4	17-7/8	15-1/4	box/box/box/box	56 lb	7.2 ft	EL	?	2910	?	\$599
27-3/4	21-7/8	15-1/4	file/file	56 lb	8.6 ft	EL	?	3009	?	\$545
27-3/4	21-7/8	15-1/4	box/box/file	59 lb	8.6 ft	EL	?	3011	?	\$596
27-3/4	21-7/8	15-1/4	box/box/box/box	56 lb	8.6 ft	EL	?	3010	?	\$625
27-3/4	27-7/8	15-1/4	file/file	67 lb	10.6 ft	EL	?	3109	?	\$620
27-3/4	27-7/8	15-1/4	box/box/file	70 lb	10.6 ft	EL	?	3111	?	\$650
27-3/4	27-7/8	15-1/4	box/box/box/box	67 lb	10.6 ft	EL	?	3110	?	\$675
27	17-7/8	15-1/4	file/file	51 lb	7.2 ft	EL	?	3809	?	\$563
27	17-7/8	15-1/4	box/box/file	53 lb	7.2 ft	EL	?	3811	?	\$617
27	21-7/8	15-1/4	file/file	55 lb	8.4 ft	EL	?	3309	?	\$569
27	21-7/8	15-1/4	box/box/file	58 lb	8.4 ft	EL	?	3311	?	\$628
24-3/4	21-7/8	15-1/4	pencil/box/file	56 lb	8.2 ft	EL	?	2719	?	\$657
24-3/4	27-7/8	15-1/4	pencil/box/file	67 lb	10.2 ft	EL	?	2819	?	\$715

Available Fronts	box and file drawers	A	B	D	F	H	I	N	P	Q	S
	pencil drawers	A	B	D	F	H	I	N	P	Q	S

TRACE PEDESTALS

SIN 33721

TRACE Hanging Pedestal



- Hangs from underneath a work surface
- Includes quick-mount attachment, for easy installation
- To specify an electronic lock instead of keyed lock, substitute an "E" for the second letter "L" of the part number and add \$340 to the list price

H	D	W	Drawer Options	Pkg Wt	Pkg Cube	Part #	Front	Part #	Metal Color	Price
13-5/8	21-7/8	15-1/4	box/box	33 lb	4.1 ft	EL	?	3623	?	\$435
19-3/8	17-7/8	15-1/4	box/file	40 lb	5.3 ft	EL	?	0503	?	\$429
19-3/8	17-7/8	15-1/4	box/box/box	43 lb	5.3 ft	EL	?	0504	?	\$618
19-3/8	21-7/8	15-1/4	box/file	43 lb	5.3 ft	EL	?	0603	?	\$442
19-3/8	21-7/8	15-1/4	box/box/box	48 lb	6.4 ft	EL	?	0604	?	\$625
25	21-7/8	15-1/4	box/box/file	52 lb	8.6 ft	EL	?	1211	?	\$641
25	21-7/8	15-1/4	file/file	52 lb	8.6 ft	EL	?	1209	?	\$588

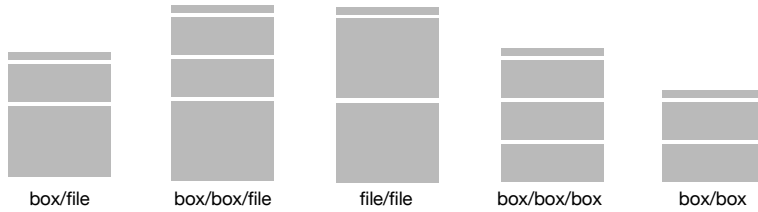

Available Fronts | A | B | D | F | H | I | N | P | Q | S

TRACE Freestanding Pedestal



- To specify an electronic lock instead of keyed lock, substitute an "E" for the second letter "L" of the part number and add \$340 to the list price

H	D	W	Drawer Options	Pkg Wt	Pkg Cube	Part #	Front	Part #	Metal Color	Price
27-3/4	18-7/8	15-1/4	file/file	68 lb	7.6 ft	EL	?	6109	?	\$552
27-3/4	18-7/8	15-1/4	box/box/file	70 lb	7.6 ft	EL	?	6111	?	\$600
27-3/4	18-7/8	15-1/4	box/box/box/box	69 lb	7.6 ft	EL	?	6110	?	\$644
27-3/4	21-7/8	15-1/4	file/file	74 lb	8.6 ft	EL	?	5109	?	\$567
27-3/4	21-7/8	15-1/4	box/box/file	76 lb	8.6 ft	EL	?	5111	?	\$618
27-3/4	21-7/8	15-1/4	box/box/box/box	75 lb	8.6 ft	EL	?	5110	?	\$662
27-3/4	27-7/8	15-1/4	file/file	83 lb	10.6 ft	EL	?	5309	?	\$637
27-3/4	27-7/8	15-1/4	box/box/file	86 lb	10.6 ft	EL	?	5311	?	\$692
27-3/4	27-7/8	15-1/4	box/box/box/box	87 lb	10.6 ft	EL	?	5310	?	\$736
24-7/8	18-7/8	15-1/4	pencil/box/file	53 lb	8 ft	EL	?	6219	?	\$781
24-7/8	21-7/8	15-1/4	pencil/box/file	55 lb	8.3 ft	EL	?	4119	?	\$803
24-7/8	27-7/8	15-1/4	pencil/box/file	67 lb	8.8 ft	EL	?	4219	?	\$859

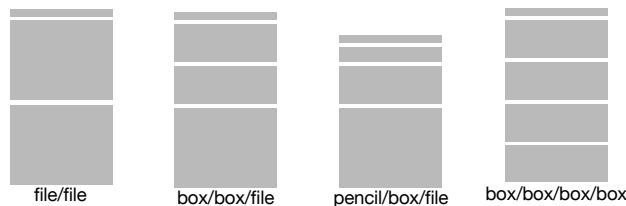

Available Fronts | box and file drawers | A | B | D | F | H | I | N | P | Q | S |
 pencil drawers | A | ~~B~~ | ~~D~~ | ~~F~~ | ~~H~~ | ~~I~~ | N | ~~P~~ | Q | S

Pedestal Accessories (Factory Installed)



file drawer divider

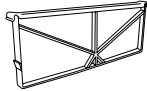

box drawer divider

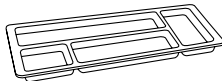

pencil tray

- Order one of these packages to be installed in the pedestal in the factory
- Black plastic pencil tray includes 4 compartments and sits on top of drawer bin sides
- Black plastic drawer dividers snap in place. The drawer divider may also be used as a file conversion bar for side-to-side filing, and as a file compressor
- Accessory package prices will be added to the standard pedestal prices

Description	Options	Part #	Price
file/file pedestals will include two 12" drawer dividers	file/file	add "A" as a suffix to the part number	\$27
box/box/file will include two 6" drawer dividers, one 12" drawer divider, and one pencil tray	box/box/file	add "A" as a suffix to the part number	\$47
box/file will include one 6" divider, one 12" divider and one pencil tray	box/file	add "A" as a suffix to the part number	\$39
pedestal will include one pencil tray	any	add "P" as a suffix to the part number	\$14

Pedestal Accessories Sold Separately

- Individual pedestal accessories, described above, are packaged and sold separately

Description	Pkg Weight	Pkg Cube	Part #	Price
single pencil tray	.5 lb	4.3	VMEX 000 29-1	\$14
single box drawer divider	.25 lb	1.7	ECOX 1070-1	\$11
single file drawer divider	.75 lb	4.3	ECOX 1071-1	\$14

Security Pedestal Upgrade



- Pedestals that include box or file drawers may be converted to a security unit by adding a lock to each drawer and a security shelf between each drawer
- This (non-UM) double-bit security lock is conical in shape and chrome plated. Please call our Customer Service for lead-time information
- Security pedestal upgrade prices will be added to the standard pedestal price

Description	Options	Part #	Price
security pedestal upgrade	file/file	Add "EY" as a suffix to the part number	\$215
	box/file	Add "EY" as a suffix to the part number	\$233
	box/box/file	Add "EY" as a suffix to the part number	\$270

Available Fronts | A B | D | F H I | N P | Q | S

Drawer Front Filler -Pedestals

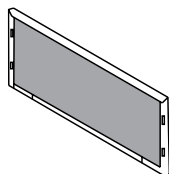

Inside View

- Pedestals with box or file drawers may be upgraded to include a closed cell polyethylene filler piece that adheres to the inside of the drawer front for improved sound dampening. (3" pencil drawers are enclosed as standard with a formed metal piece.)
- Drawer Front Filler upgrades, priced per drawer, will be added to the product list price

Description	Options	Part #	Price/Drw
drawer front filler	price per drawer	Add "U" as a suffix to the part number	\$14

Available Fronts | A | B | D | F | H | I | N | P | Q | S

TRACE LATERAL FILE SPECIFICATIONS

SIN 33721



Basic Construction

- Trace lateral files feature horizontal lines and full-width fronts consistent with all other Trace products
- All Great Openings products meet or exceed applicable ANSI-BIFMA standards for durability and safety
- Welded steel frame construction and formed channels ensure strength in key areas
- Reinforced vertical and horizontal channels ensure dimensional stability
- Top and side channels are 20 gauge cold rolled steel. Fronts, tops, outer panels are 20 and 22 gauge. Drawer bins and shelves are 18 and 20 gauge
- The lock strip on 4-high and 5-high laterals is located above the fourth drawer. In 6-high laterals, the lock strip is located above the fifth drawer
- Four leveling glides with 1-1/4" adjustment ensure proper alignment and operation
- The front-facing kick plate on Trace lateral files is 3.25" high

Features

- The top opening of 5-high and 6-high Trace laterals features an over-the-top flipper door with 13-1/4" inside clear height that will accommodate standard height binder storage
- All drawers and roll-out shelves include full extension steel ball-bearing slides with anti-rebound features to ensure smooth operation
- Trace lateral file metal and laminate tops are sized to be flush with the sides of the cabinet, so that files installed side-to-side will have no gaps between
- Drawers include full-height side panels
- Two file bars are included in each drawer, for side-to-side filing. File conversion bars for front-to-back filing are sold separately
- Drawer bins will accommodate A4, Letter, and Legal size filing

Options and Accessories

- All options and accessories are sold separately or are available as an upgrade
- Laminate drawer fronts may be specified. See the Specification Guide for details
- Common laminate tops
- Polyethylene drawer front fillers increase sound absorption
- Individually locking drawers, either keyed or electronic
- File conversion bars for front-to-back filing
- Magnetic shelf dividers
- Magnetic label
- Magnetic drawer dividers for lateral box drawers

Lock System

- All Great Openings products include randomly-assigned UM Series locks
- UM locks are black-faced, master-keyed, and core-removable
- Locks may be keyed-alike in the field
- Other key series are available, including Haworth SL, bright nickel LL, and Knoll K. See the Specification Guide for details and how to order

- Trace lateral file locking system captures drawer fronts on both sides
- Trace lateral files may be ordered to include individually locking security drawers

Counterweights & Interlock

- The safety interlock mechanism is integrated into the drawer slides, allowing only one drawer to open at a time
- All lateral files with drawers and roll-out shelves used as freestanding cabinets must have counterweight if not ganged together or otherwise anchored
- Counterweights may be factory-installed or purchased separately to be installed in the field

Load Capacity

- Drawer and roll-out shelf load capacity:
 - 30", 36", and 42" wide drawers is 125 lb
- Fixed and adjustable shelf load capacity:
 - 30" shelf: 95 lbs
 - 36" shelf: 116 lbs
 - 42" shelf: 136 lbs
- Lateral file metal top load capacity:
 - 30" wide top: 140 lbs
 - 36" wide top: 168 lbs
 - 42" wide top: 192 lbs

Trace Lateral File Inside Dimensions (in inches)

	Inner Height	Inner Width	Inner Depth
File Drawers (positioned below lock strip)			
30" wide	10.43"	26.7"	16.0"
36" wide	10.43"	32.7"	16.0"
42" wide	10.43"	38.7"	16.0"
File Drawers (positioned below other drawers)			
30" wide	10.75"	26.7"	16.0"
36" wide	10.75"	32.7"	16.0"
42" wide	10.75"	38.7"	16.0"
Top Flipper Door Opening on 5-high Trace Laterals			
30" wide	13"	26.7"	16.0"
36" wide	13"	32.7"	16.0"
42" wide	13"	38.7"	16.0"
Box Drawers (positioned below lock strip)			
30" wide	4.7"	26.7"	16.0"
36" wide	4.7"	32.7"	16.0"
42" wide	4.7"	38.7"	16.0"
Box Drawers (positioned below other drawers)			
30" wide	5.1"	26.7"	16.0"
36" wide	5.1"	32.7"	16.0"
42" wide	5.1"	38.7"	16.0"
Fixed Shelves			
30" wide	12.50"	28.5"	16.0"
36" wide	12.50"	34.5"	16.0"
42" wide	12.50"	40.5"	16.0"

TRACE LATERAL FILES

SIN 33721

TRACE Lateral File



- 5-high and 6-high include top flipper door that stows over-the-top, revealing either a roll-out or fixed shelf
- Flipper compartment features 13-1/4" inside clear height for binder storage
- Counterweight is required if not ganged together or otherwise anchored
- Laminate tops are sold separately for individual laterals and laterals paired side-by-side or back-to-back (see lateral accessory section). Please note that a laminate top may not be placed on top of a Trace lateral that includes a flipper door on the top opening
- Trace lateral files with flipper door on top, when installed in a "built-in" wall situation will require a minimum of 1-1/2" clearance above the cabinet for the flipper door to go up and over the top

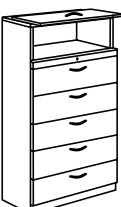
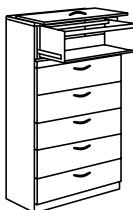
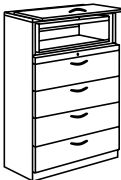

H	D	W	Cabinet Style	Contains	Pkg Wt	Pkg Cube	Part #	Front	Part #	Metal Color	Price
28-3/8	18-1/4	30			98 lb	11.8 ft	RG	?	C301	?	\$971
28-3/8	18-1/4	36	2-high	2 drawers	114 lb	14.0 ft	RG	?	C401	?	\$1,039
28-3/8	18-1/4	42			130 lb	16.2 ft	RG	?	C501	?	\$1,142
39-7/8	18-1/4	30			134 lb	16.5 ft	RG	?	C602	?	\$1,314
39-7/8	18-1/4	36	3-high	3 drawers	156 lb	19.6 ft	RG	?	C702	?	\$1,399
39-7/8	18-1/4	42			180 lb	22.7 ft	RG	?	C802	?	\$1,542
51-3/8	18-1/4	30			171 lb	22.0 ft	RG	?	C903	?	\$1,620
51-3/8	18-1/4	36	4-high	4 drawers	198 lb	26.0 ft	RG	?	D103	?	\$1,722
51-3/8	18-1/4	42			225 lb	30.0 ft	RG	?	D203	?	\$1,896
65-7/8	18-1/4	30		4 drawers	207 lb	28.0 ft	RG	?	D304	?	\$2,029
65-7/8	18-1/4	36	5-high	1 top flipper door, rollout shelf	241 lb	33.0 ft	RG	?	D404	?	\$2,156
65-7/8	18-1/4	42			275 lb	38.0 ft	RG	?	D504	?	\$2,371
65-7/8	18-1/4	30		4 drawers	205 lb	28.0 ft	RG	?	D311	?	\$1,956
65-7/8	18-1/4	36	5-high	1 top flipper door, fixed shelf	240 lb	33.0 ft	RG	?	D411	?	\$2,083
65-7/8	18-1/4	42			273 lb	38.0 ft	RG	?	D511	?	\$2,300
77-3/8	18-1/4	30		5 drawers	243 lb	32.6 ft	RG	?	E778	?	\$2,306
77-3/8	18-1/4	36	6-high	1 top flipper door, rollout shelf	283 lb	38.5 ft	RG	?	E878	?	\$2,575
77-3/8	18-1/4	42			325 lb	44.5 ft	RG	?	E978	?	\$2,792
77-3/8	18-1/4	30		5 drawers	239 lb	32.6 ft	RG	?	E7G7	?	\$2,233
77-3/8	18-1/4	36	6-high	1 top flipper door, fixed shelf	279 lb	38.5 ft	RG	?	E8G7	?	\$2,503
77-3/8	18-1/4	42			321 lb	44.5 ft	RG	?	E9G7	?	\$2,719

Available Fronts | A | B |  | F | H |  | P | Q | S

TRACE LATERAL FILES

SIN 33721

TRACE Low Height Lateral File

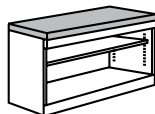
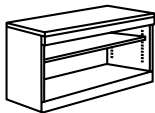

- Trace box/file lateral files require counterweight unless they are ganged back-to-back with another lateral file or otherwise tethered to a permanent structure. Without counterweights, ganging box/file lateral files side-by-side will not ensure stability
- Choosing counterweight for lateral files with box drawers requires special attention. Select the appropriate counterweight by the height of the cabinet, rather than by the number of drawers
- Open shelf lateral files do not need counterweight
- Cushion is 1-1/2" tall, an upholstered board factory-installed with screws
- 3/4 linear yard required for COM fabric (20 units or fewer)
- Unless otherwise specified, the fabric grain on all cushions will run "front-to-back"
- Open shelf unit allows for binder height storage on one shelf. Shelves adjust in 1/2" increments, and counterweight is not necessary

H	D	W	Top	Cabinet Style	Pkg Wt	Pkg Cube	Part #	Front	Part #	Metal Color	Price
22-5/8	18-1/4	30	metal	box/file	97 lb	11.8 ft	RG	?	V3L7	?	\$969
22-5/8	18-1/4	36	metal	box/file	115 lb	14.0 ft	RG	?	V4L7	?	\$1,029
22-5/8	18-1/4	42	metal	box/file	135 lb	16.2 ft	RG	?	V5L7	?	\$1,124

H	D	W	Top	Cabinet Style	Pkg Wt	Pkg Cube	Part #	Metal Color	Price
22-5/8	18-1/4	30	metal	box/file	54 lb	7.8 ft	ROS V3M9	?	\$771
22-5/8	18-1/4	36	metal	OS lateral 1 adjustable shelf	58 lb	8.1 ft	ROS V4M9	?	\$850
22-5/8	18-1/4	42	metal		62 lb	9.3 ft	ROS V5M9	?	\$926

H	D	W	Top	Cabinet Style	Wt	Cube	Part #	Front	Part #	Metal Color	Fab #	GR 1 Price	GR 2 Price	GR 3 Price	GR 4 Price	GR 5 Price	COM Price
23-1/2	18-1/4	30	1-1/2-h. cushion	box/file	90 lb	7.8 fr	RG	?	V3L7C	?	?	\$1,235	\$1,329	\$1,367	\$1,404	\$1,434	\$1,230
23-1/2	18-1/4	36	1-1/2-h. cushion	box/file	96 lb	8.1 ft	RG	?	V4L7C	?	?	\$1,310	\$1,404	\$1,442	\$1,479	\$1,509	\$1,305
23-1/2	18-1/4	42	1-1/2-h. cushion	box/file	122 lb	9.3 ft	RG	?	V5L7C	?	?	\$1,432	\$1,526	\$1,564	\$1,601	\$1,631	\$1,427

H	D	W	Top	Cabinet Style	Wt	Cube	Part #	Front	Part #	Metal Color	Fab #	GR 1 Price	GR 2 Price	GR 3 Price	GR 4 Price	GR 5 Price	COM Price
23-1/2	18-1/4	30	1-1/2-h. cushion	box/file	57 lb	7.8 ft	ROS V3M9C	?	?	?	?	\$1,042	\$1,136	\$1,174	\$1,211	\$1,241	\$1,037
23-1/2	18-1/4	36	1-1/2-h. cushion	OS lateral 1 adjustable shelf	61 lb	8.1 ft	ROS V4M9C	?	?	?	?	\$1,136	\$1,230	\$1,268	\$1,305	\$1,335	\$1,131
23-1/2	18-1/4	42	1-1/2-h. cushion		65 lb	9.3 ft	ROS V5M9C	?	?	?	?	\$1,239	\$1,333	\$1,371	\$1,408	\$1,438	\$1,234

Available Fronts | A B C D E F G H I J K L M N O P Q | S

TRACE LATERAL FILES

SIN 33721

TRACE Lateral File with Box Drawers



- All lateral files with drawers used as freestanding cabinets must have counterweight if not ganged together or otherwise anchored
- Choosing counterweight for lateral files with box drawers requires special attention. Select the appropriate counterweight by the height of the cabinet, rather than by the number of drawers

H	D	W	Cabinet Style	Contains	Pkg Wt	Pkg Cube	Part #	Front	Part #	Metal Color	Price
28-3/8	18-1/4	30	2 high	(4) box	113 lb	11.8 ft	RG	?	C307	?	\$1,373
28-3/8	18-1/4	36	2 high	(4) box	132 lb	14.0 ft	RG	?	C407	?	\$1,461
28-3/8	18-1/4	42	2 high	(4) box	151 lb	16.2 ft	RG	?	C507	?	\$1,574
28-3/8	18-1/4	30	2 high	(2) box (1) file	103 lb	11.8 ft	RG	?	C338	?	\$1,127
28-3/8	18-1/4	36	2 high	(2) box (1) file	120 lb	14.0 ft	RG	?	C438	?	\$1,193
28-3/8	18-1/4	42	2 high	(2) box (1) file	137 lb	16.2 ft	RG	?	C538	?	\$1,289
39-7/8	18-1/4	30	3 high	(6) box	159 lb	16.5 ft	RG	?	C606	?	\$1,759
39-7/8	18-1/4	36	3 high	(6) box	186 lb	19.6 ft	RG	?	C706	?	\$1,876
39-7/8	18-1/4	42	3 high	(6) box	213 lb	22.7 ft	RG	?	C806	?	\$2,028
39-7/8	18-1/4	30	3 high	(2) box (2) file	139 lb	16.5 ft	RG	?	C641	?	\$1,511
39-7/8	18-1/4	36	3 high	(2) box (2) file	162 lb	19.6 ft	RG	?	C741	?	\$1,611
39-7/8	18-1/4	42	3 high	(2) box (2) file	185 lb	22.7 ft	RG	?	C841	?	\$1,738
39-7/8	18-1/4	30	3 high	(4) box (1) file	149 lb	16.5 ft	RG	?	C6B6	?	\$1,724
39-7/8	18-1/4	36	3 high	(4) box (1) file	178 lb	19.6 ft	RG	?	C7B6	?	\$1,834
39-7/8	18-1/4	42	3 high	(4) box (1) file	212lb	22.7 ft	RG	?	C8B6	?	\$1,981
51-3/8	18-1/4	30	4 high	(8) box	206 lb	21.3 ft	RG	?	C905	?	\$2,203
51-3/8	18-1/4	36	4 high	(8) box	240 lb	25.2 ft	RG	?	D105	?	\$2,349
51-3/8	18-1/4	42	4 high	(8) box	274 lb	29.1 ft	RG	?	D205	?	\$2,533
51-3/8	18-1/4	30	4 high	(2) box (3) file	176 lb	21.3 ft	RG	?	C940	?	\$1,849
51-3/8	18-1/4	36	4 high	(2) box (3) file	204 lb	25.2 ft	RG	?	D140	?	\$1,969
51-3/8	18-1/4	42	4 high	(2) box (3) file	232 lb	29.1 ft	RG	?	D240	?	\$2,124

Available Fronts | A  Q | S

TRACE LATERAL FILES

SIN 33721

TRACE Individual-Locking Lateral File



top opening does not lock



- High security locking system with a double-bit keyed lock
- Will not key-alike with a standard UM series lock
- Drawer fronts are captured on both sides
- A security pan is included between each drawer
- The standard gang lock, which typically locks all drawers together, is not included
- A safety interlock, which allows for just one drawer to be opened at a time, is included
- Counterweight is required if not ganged together or otherwise anchored
- Contact Customer Service to discuss key series availability and lead time
- To change the keyed lock to an electronic lock, change the "RG" to an "RE" in the first part number and add \$340 list per drawer. Electronic locks may only be specified with an "A: Full Pull" drawer front
- 5-high and 6-high laterals include a non-locking flipper door with fixed shelf in the top opening

H	D	W	Cabinet Style	Contains	Pkg Wt	Pkg Cube	Part #	Front	Part #	Metal Color	Part #	Price
28-3/8	18-1/4	30	2-high		98 lb	11.8 ft	RG	?	C301	?	RY	\$1,178
28-3/8	18-1/4	36	2-high	2 drawers	114 lb	14.0 ft	RG	?	C401	?	RY	\$1,245
28-3/8	18-1/4	42	2-high		130 lb	16.2 ft	RG	?	C501	?	RY	\$1,348
39-7/8	18-1/4	30	3-high		134 lb	16.5 ft	RG	?	C602	?	RY	\$1,624
39-7/8	18-1/4	36	3-high	3 drawers	156 lb	19.6 ft	RG	?	C702	?	RY	\$1,708
39-7/8	18-1/4	42	3-high		180 lb	22.7 ft	RG	?	C802	?	RY	\$1,852
51-3/8	18-1/4	30	4-high		171 lb	22.0 ft	RG	?	C903	?	RY	\$2,034
51-3/8	18-1/4	36	4-high	4 drawers	198 lb	26.0 ft	RG	?	D103	?	RY	\$2,136
51-3/8	18-1/4	42	4-high		225 lb	30.0 ft	RG	?	D203	?	RY	\$2,310
65-7/8	18-1/4	30	5-high	4 drawers	205 lb	28.0 ft	RG	?	D311	?	RY	\$2,370
65-7/8	18-1/4	36	5-high	1 top flipper door with fixed shelf	240 lb	33.0 ft	RG	?	D411	?	RY	\$2,496
65-7/8	18-1/4	42	5-high		273 lb	38.0 ft	RG	?	D511	?	RY	\$2,714
77-3/8	18-1/4	30	6-high	5 drawers	239 lb	32.6 ft	RG	?	E7G7	?	RY	\$2,750
77-3/8	18-1/4	36	6-high	1 top flipper door with fixed shelf	279 lb	38.5 ft	RG	?	E8G7	?	RY	\$3,020
77-3/8	18-1/4	42	6-high		321 lb	44.5 ft	RG	?	E9G7	?	RY	\$3,236

Available Fronts | A | B | F | H | P | Q | S

**TRACE
Counterweight
– Factory Installed**

- In order to satisfy ANSI-BIFMA standards for stability, counterweights are required for all lateral files that include roll-out drawers or shelves if they are not ganged together or otherwise anchored
- Fixed and open shelf lateral files do not require counterweights, nor do lateral files that are anchored to a wall or ganged together. See specific lateral file descriptions to determine counterweight requirements

Cabinet Height	Description	Part #	Price
22-5/8" & 23-1/2"	30" box/file c-wt	Add a "W" suffix to the lateral file part number	\$144
22-5/8" & 23-1/2"	36" box/file c-wt		\$159
22-5/8" & 23-1/2"	42" box/file c-wt		\$184
28-3/8"	2 drawer c-wt		\$144
39-7/8"	3 drawer c-wt		\$144
51-3/8"	4 drawer c-wt		\$115
65-7/8"	5 drawer c-wt		\$115
77-3/8"	6 drawer c-wt		\$56

**TRACE
Counterweight
– Sold Separately**

- These counterweights are shipped separately to be installed at the work site
- In order to satisfy ANSI-BIFMA standards for stability, counterweights are required for all lateral files that include roll-out drawers or shelves if they are not ganged together or otherwise anchored
- Fixed and open shelf lateral files do not require counterweights, nor do lateral files that are anchored to a wall or ganged together. See specific lateral file descriptions to determine counterweight requirements

Cabinet Height	Description	Pkg Wt	Pkg Cube	Part #	Price
22-5/8" & 23-1/2"	30" box/file c-wt	42 lb	.7 ft	TRA 2300	\$236
22-5/8" & 23-1/2"	36" box/file c-wt	52 lb	.8 ft	TRA 5500	\$299
22-5/8" & 23-1/2"	42" box/file c-wt	63 lb	.8 ft	TRA 6500	\$348
28-3/8"	2 drawer c-wt	42 lb	.7 ft	TRA 2300	\$236
39-7/8"	3 drawer c-wt	42 lb	.7 ft	TRA 2300	\$236
51-3/8"	4 drawer c-wt	31.5 lb	.6 ft	TRA 4500	\$191
65-7/8"	5 drawer c-wt	31.5 lb	.6 ft	TRA 4500	\$191
77-3/8"	6 drawer c-wt	10.5 lb	.6 ft	TRA 6000	\$93

**Lateral File
Ganging Kit**

- Rather than install a counterweight, an alternate method of ensuring lateral file stability is to gang two or more laterals together side-by-side or back-to-back
- Trace box/file laterals require a counterweight unless they are ganged back-to-back with another lateral file or otherwise tethered to a permanent structure. Without counterweights, ganging box/file laterals side-by-side will not ensure stability
- Ganging kit includes a drill template, screws, and instructions



Description	Pkg Wt	Pkg Cube	Part #	Price
kit to gang two laterals together	1 lb	.2 ft	LME 100010K	\$49

TRACE LATERAL FILES

SIN 33721

TRACE Open Shelf Lateral File With Metal Top



- Box/file open shelf allows for binder storage on 1 adjustable shelf
- 2-high allows for binder storage on 1 adjustable shelf
- 3-high allows for binder storage on 2 adjustable shelves
- Shelves adjust in 1/2" increments
- Counterweight not necessary

H	D	W	Top	Shelf Options	Pkg Wt	Pkg Cube	Part #	Metal Color	Price
28-3/8	18-1/4	30	Metal	2-high	65 lb	10.0 ft	ROS X601	?	\$845
28-3/8	18-1/4	36	Metal	OS lateral	77 lb	11.3 ft	ROS X701	?	\$880
28-3/8	18-1/4	42	Metal	1 adjustable shelf	88 lb	13.0 ft	ROS X801	?	\$967
39-7/8	18-1/4	30	Metal	3-high	79 lb	13.6 ft	ROS X902	?	\$936
39-7/8	18-1/4	36	Metal	OS lateral	91 lb	16.1 ft	ROS Y102	?	\$973
39-7/8	18-1/4	42	Metal	2 adjustable shelves	103 lb	18.6 ft	ROS Y202	?	\$1,073

TRACE Mobile Lateral File



- Metal top lateral file is identical in structure to our Trace Lateral File
- Counterweight is included
- Includes black 75mm casters (2) locking and (2) non-locking

H	D	W	Top	Cabinet Style	Part #	Front	Part #	Metal Color	Price
31-1/2	18-1/4	30	metal	2-high	RG	?	C3Q6	?	\$1,254
31-1/2	18-1/4	36	metal	2-high	RG	?	C4Q6	?	\$1,341
31-1/2	18-1/4	42	metal	2-high	RG	?	C5Q6	?	\$1,465

Available Fronts | A  B  F  H  P  Q | S

TRACE Work Surface Supporting Lateral File



- TRACE lateral file without a top
- Includes top channels for mounting under a work surface
- Counterweight is not required if installed beneath a desk work surface or otherwise anchored or ganged to another cabinet
- Not to be used as a freestanding cabinet

H	D	W	Drawer Options	Pkg Wt	Pkg Cube	Part #	Front	Part #	Metal Color	Part #	Price
27-3/4	18-1/4	30	2 drawer	80 lb	11.8 ft	RG	?	C301	?	NT	\$961
27-3/4	18-1/4	36	2 drawer	102 lb	14.0 ft	RG	?	C401	?	NT	\$1,026
27-3/4	18-1/4	42	2 drawer	115 lb	16.2 ft	RG	?	C501	?	NT	\$1,122

Available Fronts | A | B  F | H  P | Q | S

TRACE LATERAL FILES

SIN 33721

TRACE Work Surface Supporting Multi-drawer FileCenter

- Includes top channels for mounting under a work surface
- All drawers include full-extension steel ball bearing slides
- Counterweight is not required if installed beneath a desk work surface or otherwise anchored or ganged to another cabinet
- Not to be used as a freestanding cabinet, because no counterweight is included
- The inside dimensions of the top box and file drawers are shown on the Trace Lateral FAQs page
- The inside dimension of the bottom lateral drawer are: height - 10.75", width - 27.3", depth - 16.0"



12-12-30



6-6-12-30

H	D	W	Cabinet Style	Pkg Wt	Pkg Cube	Part #	Front	Part #	Metal Color	Price
27-3/4	18-1/4	30-1/2	12"/12"/30"	95 lb	11.8 ft	WL	?	0102	?	\$1,228
27-3/4	18-1/4	30-1/2	6"/6"/12"/30"	105 lb	11.8 ft	WL	?	0103	?	\$1,285
27-3/4	18-1/4	30-1/2	12"/6"/6"/30"	105 lb	11.8 ft	WL	?	0104	?	\$1,285
27-3/4	18-1/4	30-1/2	6"/6"/6"/6"/30"	115 lb	11.8 ft	WL	?	0105	?	\$1,305

Available Fronts | A  B  C F | H  K P | Q | S

TRACE Individual Lateral File Laminate Top



- Laminate top may be factory-installed or shipped separately
- A laminate top may not be placed on a Trace lateral file that includes a flipper door in the top opening
- When factory-installed, the list price shown will be added to the accompanying lateral file price
- A metal top is not included when using a laminate top
- The finish height of a Trace lateral file will be 5/8" taller when using a 1-1/4" laminate top than the height of a Trace lateral file with metal top
- Specify any standard GO laminate and edge. Special order laminates may require an up-charge and/or extended lead-time; call for details
- Laminate tops used on individual lateral files are sized to be flush with the sides of the lateral file case, so that individual files installed side-by-side will have no gaps between

Description	H	W	D	Pkg Wt	Pkg Cube	Part #	Lam/Edge #	Price
factory installed	1.25	30.00	18.25	n/a	n/a	Add laminate color as a suffix to the lateral part number	?	\$369
	1.25	36.00	18.25	n/a	n/a	Add this price to lateral price	?	\$413
	1.25	42.00	18.25	n/a	n/a		?	\$458
top shipped separately	1.25	30.00	18.25	19 lb	.6 ft	FC 1931	?	\$443
	1.25	36.00	18.25	23 lb	.7 ft	FC 1937	?	\$495
	1.25	42.00	18.25	26 lb	1.0 ft	FC 1943	?	\$549

Laminate Common Tops for TRACE Lateral Files

- Common laminate tops are shipped separately, to be installed in the field
- A laminate top may not be placed on a Trace lateral file that includes a flipper door in the top opening
- The finish height of a Trace lateral file will be 5/8" taller when using a 1-1/4" laminate top than the height of a Trace lateral file with metal top
- Common top sizes allow for 1/8" overhang on all four sides
- It is recommended that you remove the metal top from lateral files before attaching the common laminate top
- Trace Work Surface Supporting Lateral Files, which are 2 drawer files and do not include metal tops, are available in this price book
- Trace lateral files may be special-ordered to not include metal tops
- Specify any standard GO laminate and edge. Special order laminates may require an up-charge and/or extended lead-time; call for details
- Lateral files that are ganged together with a common top do not need a counterweight



Two Laterals Side-by-Side:	H	W	D	Pkg Wt	Pkg Cube	Part #	Lam/Edge #	Price
(2) 30" Lateral	1.25	60.25	18.50	39 lb	.8 ft	TL 1860	?	\$501
(1) 30" & (1) 36" Lateral	1.25	66.25	18.50	43 lb	.9 ft	TL 1866	?	\$546
(2) 36" Lateral	1.25	72.25	18.50	47 lb	1.0 ft	TL 1872	?	\$590
(2) 42" Lateral	1.25	84.25	18.50	55 lb	1.1 ft	TL 1884	?	\$645

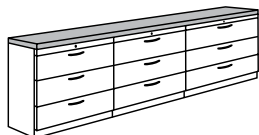

Three Laterals Side-by-Side:	H	W	D	Pkg Wt	Pkg Cube	Part #	Lam/Edge #	Price
(3) 30" Lateral	1.25	90.25	18.50	58 lb	1.2 ft	TL 1890	?	\$651
(3) 36" Lateral	1.25	108.25	18.50	70 lb	1.4 ft	TL 18108	?	\$842
(3) 42" Lateral	1.25	126.25	18.50	82 lb	1.7 ft	TL 18126	?	\$1,056



Two Laterals Back-to-Back:	H	W	D	Pkg Wt	Pkg Cube	Part #	Lam/Edge #	Price
(2) 30" Lateral	1.25	30.25	36.75	39 lb	.8 ft	TL 3730	?	\$525
(2) 36" Lateral	1.25	36.25	36.75	47 lb	1.0 ft	TL 3736	?	\$636
(2) 42" Lateral	1.25	42.25	36.75	54 lb	1.1 ft	TL 3742	?	\$641



Four Laterals Back-to-Back:	H	W	D	Pkg Wt	Pkg Cube	Part #	Lam/Edge #	Price
(4) 30" Lateral	1.25	60.25	36.75	77 lb	1.6 ft	TL 3760	?	\$845
(4) 36" Lateral	1.25	72.25	36.75	93 lb	1.9 ft	TL 3772	?	\$1,043
(4) 42" Lateral	1.25	84.25	36.75	108 lb	2.2 ft	TL 3784	?	\$1,099

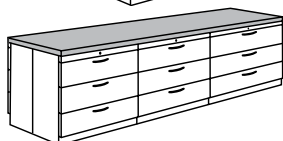

Six Laterals Back-to-Back:	H	W	D	Pkg Wt	Pkg Cube	Part #	Lam/Edge #	Price
(6) 30" Lateral	1.25	90.25	36.75	116 lb	2.5 ft	TL 3790	?	\$1,225
(6) 36" Lateral	1.25	108.25	36.75	138 lb	2.8 ft	TL 37108	?	\$1,470
(6) 42" Lateral	1.25	126.25	36.75	162 lb	3.5 ft	TL 37126	?	\$1,773

TRACE LATERAL FILES

SIN 33721

TRACE Combo Lateral File/ Storage Cabinet



- Includes two UM Series locks, keyed alike
- Units with 2-high cupboards allow binder storage on one shelf
- Units with 3-high cupboards allow binder storage on two shelves
- Counterweights are required in some models, and are included as standard

H	D	W	# 12" Drawers	Cupbd Ht	Pkg Wt	Pkg Cube	Part #	Front	Part #	Metal Color	Price
51-3/8	18-1/4	30	2 drawer	2-high	166 lb	22.0 ft	RG	?	G7B9	?	\$1,864
51-3/8	18-1/4	36	2 drawer	2-high	181 lb	25.8 ft	RG	?	G8B9	?	\$2,217
51-3/8	18-1/4	42	2 drawer	2-high	206 lb	28.6 ft	RG	?	G9B9	?	\$2,413
65-7/8	18-1/4	30	2 drawer	3-high	188 lb	26.0 ft	RG	?	H1B2	?	\$2,227
65-7/8	18-1/4	36	2 drawer	3-high	203 lb	30.8 ft	RG	?	H2B2	?	\$2,477
65-7/8	18-1/4	42	2 drawer	3-high	234 lb	35.6 ft	RG	?	H3B2	?	\$2,730
65-7/8	18-1/4	30	3 drawer	2-high	183 lb	26.0 ft	RG	?	H4B3	?	\$2,295
65-7/8	18-1/4	36	3 drawer	2-high	212 lb	30.8 ft	RG	?	H5B3	?	\$2,549
65-7/8	18-1/4	42	3 drawer	2-high	231 lb	35.6 ft	RG	?	H6B3	?	\$2,840
77-3/8	18-1/4	30	3 drawer	3-high	206 lb	30.7 ft	RG	?	H7B1	?	\$2,656
77-3/8	18-1/4	36	3 drawer	3-high	234 lb	36.4 ft	RG	?	H8B1	?	\$2,952
77-3/8	18-1/4	42	3 drawer	3-high	260 lb	42.1 ft	RG	?	H9B1	?	\$3,289
77-3/8	18-1/4	30	4 drawer	2-high	210 lb	30.7 ft	RG	?	J1B4	?	\$2,722
77-3/8	18-1/4	36	4 drawer	2-high	230 lb	36.4 ft	RG	?	J2B4	?	\$3,028
77-3/8	18-1/4	42	4 drawer	2-high	254 lb	42.1 ft	RG	?	J3B4	?	\$3,372

B, H, and P fronts will include "A" pull on cupboard doors

Available Fronts | A | B | F | H | P | Q | S

TRACE LATERAL FILES

SIN 33721

TRACE Combo Lateral File/ Open Shelves

- Includes one UM Series lock
- Units with 2-high shelves allow binder storage on one shelf
- Units with 3-high shelves allow binder storage on two shelves
- Counterweights are required in some models, and are included as standard



H	D	W	# 12" Drawers	Shelf Ht	Pkg Wt	Pkg Cube	Part #	Front	Part #	Metal Color	Price
51-3/8	18-1/4	30	2 drawer	2-high	159 lb	22.0 ft	RG	?	F1A8	?	\$1,745
51-3/8	18-1/4	36	2 drawer	2-high	188 lb	25.8 ft	RG	?	F2A8	?	\$1,916
51-3/8	18-1/4	42	2 drawer	2-high	199 lb	28.6 ft	RG	?	F3A8	?	\$2,112
65-7/8	18-1/4	30	2 drawer	3-high	174 lb	26.0 ft	RG	?	F490	?	\$2,006
65-7/8	18-1/4	36	2 drawer	3-high	200 lb	30.8 ft	RG	?	F590	?	\$2,252
65-7/8	18-1/4	42	2 drawer	3-high	216 lb	35.6 ft	RG	?	F690	?	\$2,506
65-7/8	18-1/4	30	3 drawer	2-high	168 lb	26.0 ft	RG	?	F789	?	\$2,109
65-7/8	18-1/4	36	3 drawer	2-high	194 lb	30.8 ft	RG	?	F889	?	\$2,363
65-7/8	18-1/4	42	3 drawer	2-high	212 lb	36.6 ft	RG	?	F989	?	\$2,654
77-3/8	18-1/4	30	3 drawer	3-high	183 lb	30.7 ft	RG	?	G197	?	\$2,434
77-3/8	18-1/4	36	3 drawer	3-high	206 lb	36.4 ft	RG	?	G297	?	\$2,730
77-3/8	18-1/4	42	3 drawer	3-high	229 lb	42.1 ft	RG	?	G397	?	\$3,064
77-3/8	18-1/4	30	4 drawer	2-high	179 lb	30.7 ft	RG	?	G498	?	\$2,538
77-3/8	18-1/4	36	4 drawer	2-high	202 lb	36.4 ft	RG	?	G598	?	\$2,842
77-3/8	18-1/4	42	4 drawer	2-high	224 lb	42.1 ft	RG	?	G698	?	\$3,185

Available Fronts | A | B | ~~D~~ | F | H | ~~K~~ | ~~N~~ | P | Q | S

**Magnetic
Shelf Divider**

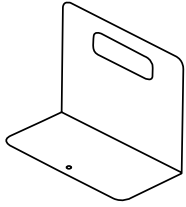

- Black magnetic dividers are 7.5" tall and 8" wide, with a 4" base. Magnet is 7-7/8" x 3"
- Appropriate for use on any lateral file drawer or shelf, bookcase, double door storage cabinet or overhead storage cabinet

H	D	W	Description	Pkg Wt	Pkg Cube	Part #	Price
7-1/2	4	8	(package of 3)	2 lb	2 ft	LFM 300 30	\$54

Spec Guide Personal Storage Pedestals **Laterals** Lockers Towers Storage Cabinets Bookcases Cayenne Ht Adj Tables Trace Desk Desk Accessories Sparkology Terms/Conds

Magnetic Label



- Magnetic labels adhere to any metal surface to identify contents
- Label dimensions are 1" high x 3" wide

Description	H	W	Pkg Wt	Pkg Cube	Part #	Price
(package of 10)	1	3	.2 lb	.08 ft	TGOX 000 11K	\$40

**Lateral File
Conversion Bar**

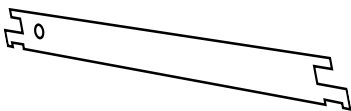

- Conversion bars allow for front-to-back filing in 18-1/4" and 17-3/8" deep lateral files. Use 2 bars each in 36" and 42" lateral drawers for legal size filing

Description	Pkg Wt	Pkg Cube	Part #	Price
(package of 4)	2 lb	.8 ft	LME 4500 19	\$29

"How many standard file conversion bars do I need?"

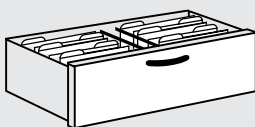

- 30" Wide Lateral**
- 2 file conversion bars per drawer
 - 15.5" x 2 rows = 31" filing space

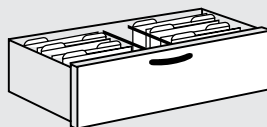

- 36" Wide Lateral**
- 2 file conversion bars per drawer
 - 15.5" x 2 rows = 31" filing space

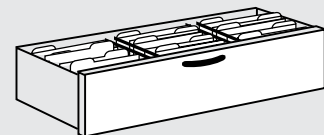

- 42" Wide Lateral**
- 4 file conversion bars per drawer
 - 15.5" x 3 rows = 46.5" filing space

**Drawer Front
Filler For TRACE
Lateral Files**

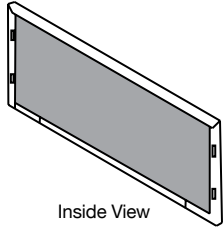

- Lateral drawers may be upgraded to include a closed cell polyethylene filler piece that adheres to the inside of the drawer front for improved sound dampening
- Drawer Front Filler upgrades, priced per drawer, will be added to the product list price

Descriptions	Pkg Wt	Pkg Cube	Part #	Price Per Drawer
price per drawer	2 lb	.8 ft	Add a "U" as a suffix to the part number	\$64
Available Fronts A B D F H J K P Q S				

**Magnetic
Drawer Dividers
For Box Drawer**

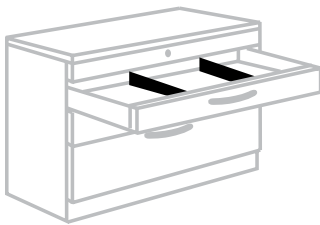

- Dividers fit inside box lateral drawer bins to create sectioned drawer space
- 16" depth divider fits front-to-back in drawer bin, painted black
- Magnets attach to front and back of drawer bin

Description	Pkg Wt	Pkg Cube	Part #	Price
pkg of (4) 16" x 4" dividers	22 lb	1.8 ft	LFM 40042K	\$94



Basic Construction

- While TRACE lateral files feature horizontal lines and full-width fronts consistent with all other TRACE products, Recessed Front lateral files have in-set drawer fronts and the flipper doors stow inside the cabinet
- Recessed Front lateral files finish at different heights and have completely different horizontal lines than the TRACE products
- Recessed Front lateral files are available with three different front styles:
A: Full Pull, F: Square Recessed Pull, and H: HW Pull. These recessed style pulls allow the 12" flipper door to recede fully inside the cabinets
- All Great Openings products meet or exceed applicable ANSI-BIFMA standards for durability and safety
- Steel frame construction is welded and channels are formed in key areas for strength
- Reinforced vertical and horizontal channels ensure dimensional stability
- Inner frame is 20 gauge metal. Fronts, tops, outer panels are 20 and 22 gauge. Drawer bins and shelves are 18 and 20 gauge
- Four leveling glides with 1-1/4" adjustment are included to ensure proper drawer alignment and operation

Features

- Positive self-closing hinges and door follower channel provide superior flipper door tracking and a snug door closure. The doors are drawn in when closed to ensure uniform door alignment
- Flipper doors include a built-in sound absorption feature in the flipper door for quiet operation
- 12" receding flipper doors stow completely inside the cabinet
- 15" receding flipper doors extend 2-1/4" outside the front of the cabinet. Please allow for this clearance when creating your floor plan
- All drawers and roll-out shelves include full extension steel ball-bearing slides with anti-rebound features to ensure smooth operation
- Drawer includes full-height side panels
- Two file bars are included in each drawer for side-to-side filing
- All Great Openings' lateral drawer bins will accommodate A4, Letter, and Legal size filing

Options and Accessories

- All options and accessories are sold separately or are available as an upgrade
- Laminate drawer fronts may be specified. See the Specification Guide for details
- Common laminate tops
- Polyethylene drawer front fillers increase sound absorption
- File conversion bars for front-to-back filing
- Magnetic shelf dividers
- Magnetic label

Lock System

- All Great Openings products include randomly-assigned UM Series locks
- UM locks are black-faced, master-keyed, and core-removable
- Locks may be keyed-alike in the field
- Other key series are available, including Haworth SL, bright nickel LL, and Knoll K. See the Specification Guide for details and how to order
- The locking system captures drawer fronts on both sides

Counterweight & Interlock

- The safety interlock mechanism is integrated into the drawer slides, allowing only one drawer to open at a time
- All lateral files with drawers and roll-out shelves used as freestanding cabinets must have counterweight if not ganged together or otherwise anchored
- Counterweights may be factory-installed or purchased separately to be installed in the field

Load Capacity

- Drawer and roll-out shelf load capacity:
 - 30", 36", and 42" wide drawers: 125 lb
- Fixed and adjustable shelf load capacity:
 - 30" shelf: 95 lbs
 - 36" shelf: 116 lbs
 - 42" shelf: 136 lbs
- Lateral file metal top load capacity:
 - 30" wide top: 140 lbs
 - 36" wide top: 168 lbs
 - 42" wide top: 192 lbs

Inside Dimensions

(in inches)

	Inner Height	Inner Width	Inner Depth
File Drawers			
30" wide	11.25"	26.7"	16.0"
36" wide	11.25"	32.7"	16.0"
42" wide	11.25"	38.7"	16.0"
12" Receding Door (fixed shelves)			
30" wide	10.3"	28.6"	16.5"
36" wide	10.3"	34.6"	16.5"
42" wide	10.3"	40.6"	16.5"
12" Receding Door (roll-out shelves)			
30" wide	10.25"	26.7"	16.0"
36" wide	10.25"	32.7"	16.0"
42" wide	10.25"	38.7"	16.0"
15" Receding Door (fixed shelves)			
30" wide	12.5"	28.6"	16.5"
36" wide	12.5"	34.6"	16.5"
42" wide	12.5"	40.6"	16.5"

RECESSED FRONT LATERAL FILES

SIN 33721

Recessed Front Lateral File



- 3-high and 5-high lateral files may be specified with all drawers, or with a receding door in the top opening with either a fixed or rollout shelf
- The receding door in these lateral files is approximately 12" high; when open, the door stows fully inside the cabinet
- Counterweight required if not ganged together or otherwise anchored
- Individual locking drawers not available

H	D	W	Cabinet Style	Contains	Pkg Wt	Pkg Cube	Part #	Front	Part #	Metal Color	Price
27-3/4	17-3/8	30	2-high	2 drawers	93 lb	11.8 ft	RG	?	0101	?	\$1,137
27-3/4	17-3/8	36	2-high	2 drawers	108 lb	14.0 ft	RG	?	0201	?	\$1,264
27-3/4	17-3/8	42	2-high	2 drawers	123 lb	16.2 ft	RG	?	0301	?	\$1,382
39-7/8	17-3/8	30	3-high	3 drawers	129 lb	16.5 ft	RG	?	0402	?	\$1,494
39-7/8	17-3/8	36	3-high	3 drawers	150 lb	19.6 ft	RG	?	0502	?	\$1,652
39-7/8	17-3/8	42	3-high	3 drawers	171 lb	22.7 ft	RG	?	0602	?	\$1,803
39-7/8	17-3/8	30	3-high	2 drawers 1 rec. door, fixed shelf	129 lb	16.5 ft	RG	?	04D6	?	\$1,583
39-7/8	17-3/8	36	3-high	2 drawers 1 rec. door, fixed shelf	150 lb	19.6 ft	RG	?	05D6	?	\$1,840
39-7/8	17-3/8	42	3-high	2 drawers 1 rec. door, fixed shelf	171 lb	22.7 ft	RG	?	06D6	?	\$2,098
52	17-3/8	30	4-high	4 drawers	166 lb	21.3 ft	RG	?	0703	?	\$1,846
52	17-3/8	36	4-high	4 drawers	192 lb	25.2 ft	RG	?	0803	?	\$2,034
52	17-3/8	42	4-high	4 drawers	218 lb	29.1 ft	RG	?	0903	?	\$2,218
64-1/8	17-3/8	30	5-high	5 drawers	202 lb	26.0 ft	RG	?	1008	?	\$2,413
64-1/8	17-3/8	36	5-high	5 drawers	235 lb	31.0 ft	RG	?	1108	?	\$2,672
64-1/8	17-3/8	42	5-high	5 drawers	268 lb	35.6 ft	RG	?	1208	?	\$2,928
64-1/8	17-3/8	30	5-high	4 drawers 1 rec. door, fixed shelf	202 lb	26.0 ft	RG	?	1011	?	\$2,228
64-1/8	17-3/8	36	5-high	4 drawers 1 rec. door, fixed shelf	235 lb	31.0 ft	RG	?	1111	?	\$2,418
64-1/8	17-3/8	42	5-high	4 drawers 1 rec. door, fixed shelf	268 lb	35.6 ft	RG	?	1211	?	\$2,600
64-1/8	17-3/8	30	5-high	4 drawers 1 rec. door, rollout shelf	202 lb	26.0 ft	RG	?	1004	?	\$2,413
64-1/8	17-3/8	36	5-high	4 drawers 1 rec. door, rollout shelf	235 lb	31.0 ft	RG	?	1104	?	\$2,672
64-1/8	17-3/8	42	5-high	4 drawers 1 rec. door, rollout shelf	268 lb	35.6 ft	RG	?	1204	?	\$2,928

Available Fronts | A  F | H 

RECESSED FRONT LATERAL FILES

SIN 33721

Recessed Front Lateral File Counterweight - Factory Installed

- In order to satisfy ANSI-BIFMA standards for stability, counterweights are required for all lateral files that include roll-out drawers or shelves if they are not ganged together or otherwise anchored
- Fixed shelf lateral files do not require counterweights, nor do lateral files that are anchored to a wall or ganged together. See specific lateral file descriptions to determine counterweight requirements

Description	Part #	Price
2 drawer c-wt		\$179
3 drawer c-wt	Add a "W" suffix to the lateral file part number	\$142
4 drawer c-wt		\$102
5 drawer c-wt		\$67

Recessed Front Lateral File Counterweight - Sold Separately

- These counterweights are shipped separately to be installed at the work site
- In order to satisfy ANSI-BIFMA standards for stability, counterweights are required for all lateral files that include roll-out drawers or shelves if they are not ganged together or otherwise tethered
- Fixed shelf lateral files do not require counterweights, nor do lateral files that are anchored to a wall or ganged together. See specific lateral file descriptions to determine counterweight requirements

Description	Pkg Wt	Pkg Cube	Part #	Price
2 drawer c-wt	42 lb	.7 ft	SME 220019	\$245
3 drawer c-wt	31.5 lb	.7 ft	SME 230019	\$209
4 drawer c-wt	21 lb	.6 ft	SME 240019	\$142
5 drawer c-wt	10.5 lb	.6 ft	SME 250019	\$86

Lateral File Ganging Kit

- Rather than install a counterweight, an alternate method of ensuring lateral file stability is to gang two or more laterals together side-by-side
- Ganging kit includes a drill template, screws, and instructions for attaching two laterals together



Description	Pkg Wt	Pkg Cube	Part #	Price
kit to gang laterals together	1 lb	.2 ft	LME 100010K	\$49

RECESSED FRONT LATERAL FILES

SIN 33721

12" Receding Door Lateral File with Roll-Out or Fixed Shelves



- All doors flip-up and recede fully inside the cabinet
- Choose from fixed or roll-out shelves
- Counterweight is required in lateral files with roll-out shelves if not ganged together or otherwise anchored

H	D	W	Cabinet Style	Contains	Pkg Wt	Pkg Cube	Part #	Front	Part #	Metal Color	Price
27-3/4	17-3/8	30	2-high		82 lb	11.8 ft	RG	?	0142	?	\$1,528
27-3/4	17-3/8	36	2-high	2 rec. doors roll-out shelves	104 lb	14.0 ft	RG	?	0242	?	\$1,781
27-3/4	17-3/8	42	2-high		118 lb	16.2 ft	RG	?	0342	?	\$1,995
39-7/8	17-3/8	30	3-high		127 lb	16.5 ft	RG	?	0421	?	\$2,070
39-7/8	17-3/8	36	3-high	3 rec. doors fixed shelves	148 lb	19.6 ft	RG	?	0521	?	\$2,349
39-7/8	17-3/8	42	3-high		169 lb	22.7 ft	RG	?	0621	?	\$2,640
39-7/8	17-3/8	30	3-high		129 lb	16.5 ft	RG	?	0443	?	\$2,149
39-7/8	17-3/8	36	3-high	3 rec. doors roll-out shelves	150 lb	19.6 ft	RG	?	0543	?	\$2,428
39-7/8	17-3/8	42	3-high		171 lb	22.7 ft	RG	?	0643	?	\$2,714
52	17-3/8	30	4-high		147 lb	21.3 ft	RG	?	0722	?	\$2,635
52	17-3/8	36	4-high	4 rec. doors fixed shelves	171 lb	25.2 ft	RG	?	0822	?	\$3,004
52	17-3/8	42	4-high		204 lb	29.1 ft	RG	?	0922	?	\$3,439
52	17-3/8	30	4-high		149 lb	21.3 ft	RG	?	0744	?	\$2,714
52	17-3/8	36	4-high	4 rec. doors roll-out shelves	173 lb	25.2 ft	RG	?	0844	?	\$3,083
52	17-3/8	42	4-high		207 lb	29.2 ft	RG	?	0944	?	\$3,439
64-1/8	17-3/8	30	5-high		179 lb	26.0 ft	RG	?	1023	?	\$3,238
64-1/8	17-3/8	36	5-high	5 rec. doors fixed shelves	214 lb	30.8 ft	RG	?	1123	?	\$3,643
64-1/8	17-3/8	42	5-high		236 lb	35.6 ft	RG	?	1223	?	\$4,077
64-1/8	17-3/8	30	5-high		181 lb	26.0 ft	RG	?	1045	?	\$3,318
64-1/8	17-3/8	36	5-high	5 rec. doors roll-out shelves	216 lb	30.8 ft	RG	?	1145	?	\$3,722
64-1/8	17-3/8	42	5-high		238 lb	35.6 ft	RG	?	1245	?	\$4,156

Available Fronts | A  F | H 

Spec Guide Personal Storage Pedestals **Laterals** Lockers Towers Storage Cabinets Bookcases Cayenne Ht Adj Tables Trace Desk Desk Accessories Sparkology Terms/Conds

RECESSED FRONT LATERAL FILES

SIN 33721

15" Receding Door Lateral File with Fixed Shelves



- All doors flip-up and recede inside cabinet
- When open, 15" receding flipper doors extend 2-1/4" outside the front of the cabinet
- All shelves are fixed
- No counterweight is necessary

H	D	W	Cabinet Style	Contains	Pkg Wt	Pkg Cube	Part #	Front	Part #	Metal Color	Price
64-1/8	17-3/8	30	4-high	4 door	178 lb	26.0 ft	RG	?	1049	?	\$2,074
64-1/8	17-3/8	36	4-high	4 door	213 lb	30.8 ft	RG	?	1149	?	\$2,307
64-1/8	17-3/8	42	4-high	4 door	228 lb	35.6 ft	RG	?	1249	?	\$2,540
79-3/8	17-3/8	30	5-high	5 door	186 lb	26.0 ft	RG	?	1650	?	\$2,549
79-3/8	17-3/8	36	5-high	5 door	220 lb	37.7 ft	RG	?	1750	?	\$2,835
79-3/8	17-3/8	42	5-high	5 door	238 lb	43.6 ft	RG	?	1850	?	\$3,119

Available Fronts | A F | H

15" Receding Door Lateral File with Standard Drawers



- Top 1 or 2 openings include 15" flipper doors that recede inside the cabinet, with fixed shelves
- When open, 15" receding flipper doors extend 2-1/4" outside the front of the cabinet
- Bottom 3 or 4 openings include standard height drawers
- Counterweights are required if not ganged together or otherwise anchored

H	D	W	Cabinet Style	Contains	Pkg Wt	Pkg Cube	Part #	Front	Part #	Metal Color	Price
67-1/8	17-3/8	30	5-high	(1) 15" receding doors fixed shelf 4 std drawers	202 lb	22.9 ft	RG	?	3970	?	\$2,555
67-1/8	17-3/8	36	5-high	(1) 15" receding doors fixed shelf 4 std drawers	237 lb	27.5 ft	RG	?	4070	?	\$2,611
67-1/8	17-3/8	42	5-high	(1) 15" receding doors fixed shelf 4 std drawers	252 lb	32.1 ft	RG	?	4170	?	\$2,723
70-1/4	17-3/8	30	5-high	(2) 15" receding doors fixed shelf 3 std drawers	166 lb	23.4 ft	RG	?	2475	?	\$2,586
70-1/4	17-3/8	36	5-high	(2) 15" receding doors fixed shelf 3 std drawers	200 lb	28.1 ft	RG	?	2575	?	\$2,639
70-1/4	17-3/8	42	5-high	(2) 15" receding doors fixed shelf 3 std drawers	218 lb	32.8 ft	RG	?	2675	?	\$2,770

Available Fronts | A F | H

RECESSED FRONT LATERAL FILES

SIN 33721

Individual Laminate Tops for Recessed Front Lateral



- Factory installed or shipped separately
- List price shown will be added to the accompanying lateral price
- Metal top is not included when using a laminate top
- Finish height of lateral file will be 5/8" taller than the height of a standard Recessed Front lateral file with metal top
- Specify any standard GO laminate and edge. Special order laminates may require an up-charge; call for details
- Laminate tops used on individual lateral files are sized to be flush with the sides of the lateral, so that individual laterals installed side-by-side will have no gaps between

Description	H	W	D	Pkg Wt	Pkg Cube	Part #	Lam/Edge #	Price
factory installed	1.25	30.00	17.375	n/a	n/a	Add laminate color number as a suffix to the lateral part number	?	\$369
	1.25	36.00	17.375	n/a	n/a		?	\$413
	1.25	42.00	17.375	n/a	n/a		?	\$458
top shipped separately	1.25	30.00	17.375	19 lb	.6 ft	SLEX030	?	\$443
	1.25	36.00	17.375	23 lb	.7 ft	SLEX036	?	\$495
	1.25	42.00	17.375	26 lb	1.0 ft	SLEX042	?	\$549

Common Laminate Tops for Recessed Front Lateral

- Laminate tops ordered separately for field installation
- Specify any standard GO laminate and edge. Special order laminates may require an up-charge; call for details
- Note that these tops will fit ONLY Recessed Lateral Files
- It is recommended that you remove the metal top from lateral files before attaching the common laminate top

Two Laterals Side-by-Side:	W	D	Pkg Wt	Pkg Cube	Part #	Lam/Edge #	Price
(2) 30" laterals	60.25	17.625	37 lb	.8 ft	LL1760	?	\$501
(1) 30" & (1) 36" lateral	66.25	17.625	41 lb	.9 ft	LL1766	?	\$546
(2) 36" laterals	72.25	17.625	45 lb	1.0 ft	LL1772	?	\$590
(2) 42" laterals	84.25	17.625	52 lb	1.1 ft	LL1784	?	\$645

Three Laterals Side-by-Side:	W	D	Pkg Wt	Pkg Cube	Part #	Lam/Edge #	Price
(3) 30" laterals	90.25	17.625	56 lb	1.2 ft	LL1790	?	\$651
(3) 36" laterals	108.25	17.625	67 lb	1.4 ft	LL17108	?	\$842
(3) 42" laterals	126.25	17-5/8	78 lb	1.7 ft	LL17126	?	\$1,056

Two Laterals Back-to-Back:	W	D	Pkg Wt	Pkg Cube	Part #	Lam/Edge #	Price
(2) 30" laterals	30.25	35.00	37 lb	.8 ft	LL 3530	?	\$525
(2) 36" laterals	36.25	35.00	45 lb	1.0 ft	LL 3536	?	\$636
(2) 42" laterals	42.25	35.00	52 lb	1.1 ft	LL 3542	?	\$641

Four Laterals in Quads:	W	D	Pkg Wt	Pkg Cube	Part #	Lam/Edge #	Price
(4) 30" laterals	60.25	35.00	74 lb	1.6 ft	LL 3560	?	\$845
(4) 36" laterals	72.25	35.00	88 lb	1.9 ft	LL 3572	?	\$1,043
(4) 42" laterals	84.25	35.00	103 lb	2.2 ft	LL 3584	?	\$1,099



**Magnetic Shelf
Divider**

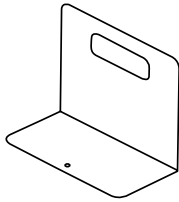

- Black magnetic dividers are 7.5" tall and 8" wide, with a 4" base. Magnet is 7-7/8" x 3"
- Appropriate for use on any lateral file drawer or shelf, bookcase, double door storage cabinet or overhead storage cabinet

H	D	W	Description	Pkg Wt	Pkg Cube	Part #	Price
7-1/2	4	8	(package of 3)	2 lb	2 ft	LFM 300 30	\$54

Magnetic Label



- Magnetic labels adhere to any metal surface to identify drawer contents
- Label dimensions are 1" high x 3" wide

H	W	Description	Pkg Wt	Pkg Cube	Part #	Price
1	3	(package of 10)	.2 lb	.08 ft	TGOX 000 11K	\$40

**Lateral File
Conversion Bar**



- Conversion bars allow for front-to-back filing in 18-1/4" and 17-3/8" deep lateral files. Use 2 bars each in 36" and 42" lateral drawers for legal size filing

Description	Pkg Wt	Pkg Cube	Part #	Price
(package of 4)	2 lb	.8 ft	LME 4500 19	\$29

"How many standard file conversion bars do I need?"

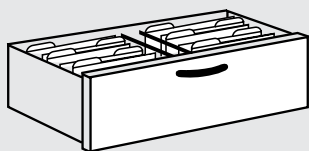

- 30" Wide Lateral**
- 2 file conversion bars per drawer
 - 15.5" x 2 rows = 31" filing space

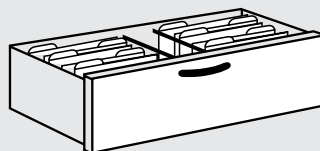

- 36" Wide Lateral**
- 2 file conversion bars per drawer
 - 15.5" x 2 rows = 31" filing space

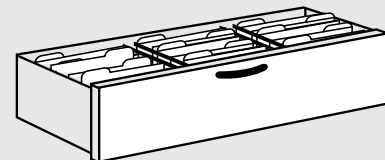

- 42" Wide Lateral**
- 4 file conversion bars per drawer
 - 15.5" x 3 rows = 46.5" filing space

**Drawer
Front Filler
For Recessed
Lateral Files**

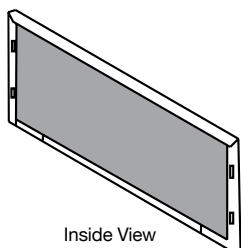

Inside View

- Lateral drawers may be upgraded to include a closed cell polyethylene filler piece that adheres to the inside of the drawer front for improved sound dampening
- Drawer Front Filler upgrades, priced per drawer, will be added to the product list price
- For Recessed Front Lateral Files, these drawer front fillers are not needed on flipper doors, because we provide other sound-absorbent material in the door construction

Descriptions	Pkg Wt	Pkg Cube	Part #	Price/Drawer
Price per drawer	2 lb	.8 ft	Add a "U" as a suffix to the part number	\$64

Available Fronts | A 

Basic Construction

- All Great Openings products meet or exceed applicable ANSI-BIFMA standards for durability and safety
- Welded steel frame construction and formed channels ensure strength in key areas
- Reinforced vertical and horizontal channels ensure dimensional stability
- Top and side channels are 20 gauge cold rolled steel. Fronts, tops, outer panels are 20 and 22 gauge. Shelves are 18 and 20 gauge
- Four leveling glides with 7/8" adjustment ensure proper alignment and operation, and are accessible from inside the locker
- Lockers include inner side panels, so that structural components are concealed
- The front-facing kick plate on Trace lockers is 3.25" high

Features

- Lockers are shipped fully assembled
- Lockers may be ordered with metal or laminate fronts
- Multiple color door order forms make it easy to mix and match door colors
- Lockers include either coat hooks or coat rod; see individual product descriptions
- Additional shelves are available for order
- All single door lockers include shelf clip holes in the side panels, to accommodate additional shelves that are sold separately. The top-most shelf position allows for 12" clear height above the shelf.

Options and Accessories

- All options and accessories are sold separately or are available as an upgrade
- Choose from keyed locks, electronic locks, or hasp locks
- Interior power outlets may be installed inside locker compartments. Contact Sales for specification and pricing
- Locker door number plates, stainless steel laser etched with any combination of numbers needed to permanently identify individual locker doors
- Laminate common tops
- Locker ganging kit, for ganging lockers side-to-side
- Sloped tops
- Locker venting
- Mail slots

Interior Power Outlet

- Specify a 110v power outlet inside the locker compartment
- A multi-circuit power feed can accommodate up to 32 lockers, with plug-in power inside each locker and wires routed outside and behind the cabinets
- Contact Sales for specification assistance and pricing

Keyed Lock System

- Keyed locks include randomly-assigned UM Series locks
- UM locks are black-faced, master-keyed, and core-removable
- Locks may be keyed-alike in the field
- Other key series are available, including Haworth SL, bright nickel LL, and Knoll K. See the Specification Guide for details and how to order

Hasp Locks

- Hasp locks may be used instead of a keyed or electronic lock
- Hasp lock on metal door includes the A: Full Pull
- Available on laminate doors
- To order, specify "Hasp Lock" in the product description on your purchase order and add \$50 list per door to the keyed locker price



Sloped tops



Vents



Mail Slots



Interior Power Outlet (Horizontal)

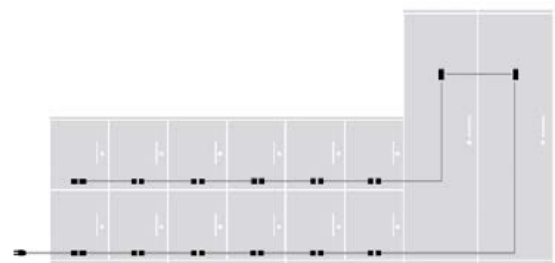

Power routing on backs of lockers



E-Lock

E-Lock (E)

- Durable and versatile, electronic locks may be programmed to either fixed or revolving mode
- Fixed Mode: Once a code is created, that code remains in effect until the user changes it. To lock and unlock, simply enter the code and then turn the lever
- Revolving Mode: Also called hoteling or single use mode, the code is cleared after each complete locking cycle. To lock: enter a code and then turn the lever. To unlock: enter the same code and turn the lever. At this point the lock clears the code and is awaiting new input

- Electronic Lock Features:
 - Once a code is entered, the lock is activated by turning the lever to the locked or unlocked position
 - Runs on (2) AAA batteries (included)
 - Operates using a 4-to-8 digit code
 - A supervisor code is included
 - For large projects, the supervisor code may be pre-programmed into the locks
 - May be programmed by the supervisor as Fixed or Revolving Code
 - Includes programmable reset features
 - Easy to clean membrane keypad
 - 75,000 plus cycles; extended battery life reduces replacement and labor maintenance costs
- 1 year warranty



E-Lock Mini Keypad

E-Lock Mini Keypad (VM)

- Keypad operation
- Cam locking mechanism
- Manage with electronic keys
- Dual functionality – shared or assigned use
- Management override and power bypass
- All metal housing
- Brushed nickel finish
- Vertical orientation – knob on the top
- Visual and audible indicators

- Available with advanced features*
 - Mobile app management
 - Audit trail
 - Advanced auto unlock feature
 - Advanced system tools
- IP55 rated, FCC, CE, and CI certified
- ADA compliant models available
- Powered by 2 lithium CR2450 batteries
- Battery Life: 180,000 cycles with average use
- 2 year warranty



E-Lock Mini RFID

E-Lock Mini RFID (RM)

- Touch RFID operation
- RFID standards - iClass and Mifare (13.56 MHz) ISO 14443A • ISO 14443B • ISO 15693
- Cam locking mechanism
- Manage with electronic keys
- Shared or assigned use
- Management override and power bypass
- All metal housing
- Brushed nickel finish
- Vertical orientation knob on the top

- Visual and audible indicators
- Available with advanced features*
 - Mobile app management
 - Audit trail
 - Advanced auto unlock feature
 - Advanced system tools
- IP55 rated, FCC, CE, and CI certified
- ADA compliant models available
- Powered by 4 premium AA batteries
- Battery Life: 115,000 cycles with average use
- 2 year warranty

Helpful Hint:

See page 56 for E-lock mini and E-lock RFID Key Management accessories

Standard Door Pulls



A – Full Pull



S – Satin Nickel Loop Pull Square Front



Q – Bar Pull Square Front

E-Lock Door Pulls



E-Lock Square Front or A-Full Pull



E-Lock Mini Keypad Square Front



E-Lock Mini RFID Square Front

TRACE Locker Inside Dimensions (in inches)

Description	Interior Dimension Per/Locker Opening					
	Height	Width			Depth	
		12" W	15" W	18" W	18" D	24" D
Single Lockers						
Single Locker 27-3/4"H	23.750	10.580"	13.580"	16.580"	17.156"	23.156
Single Locker 34-3/4"H	30.750	10.580"	13.580"	16.580"	17.156"	23.156
Single Locker 39-7/8"H	35.875"	10.580"	13.580"	16.580"	17.156"	23.156
Single Locker 51-3/8" H	47.375"	10.580"	13.580"	16.580"	17.156"	23.156
Single Locker 65-7/8"H	61.875"	10.580"	13.580"	16.580"	17.156"	23.156
Above Shelf	12.000"	10.580"	13.580"	16.580"	17.156"	23.156
Double Lockers						
Top Locker	30.828"	10.580"	13.580"	16.580"	17.156"	23.156
Bottom Locker	30.279"	10.580"	13.580"	16.580"	17.156"	23.156
Quad Lockers						
Top Lockers	30.828"	10.580"	13.580"		17.156"	23.156
Bottom Lockers	30.279"	10.580"	13.580"		17.156"	23.156
Cubby Lockers						
All Cubbies	14.750"	10.580"	13.580"		17.156"	
Personal Locker						
Personal Locker	61.875"	See sell sheet for details			17.156"	
Above Shelf	12.000"					
Mini Lockers						
Freestanding and Mobile	16.250"	8.580"			17.406"	



Single Lockers

- 27-3/4" high lockers include one adjustable shelf, but no coat rod or hooks
- 34-3/4" high locker includes coat hook and slots for adjustable shelves
- 39-7/8" high lockers include coat hooks or rods and optional shelves
- 51-3/8" and 65-7/8" high lockers include one adjustable shelf on top, with up to 12" clear height above the shelf
- The 18" deep lockers include (2) two-pronged coat hooks, one on each side. The 24" deep lockers include (1) side-to-side coat rod

Part #	Description	Base Price	Laminate Door	E-Lock	E-Lock Mini	E-Lock RFID	Hasp	Slope Top	Pkg Wt	Pkg Cube
4R28	27-3/4"h x 18"d x 12"w	\$834	+\$258	+\$340	+\$275	+\$350	+\$50	+210	40 lb	3.9 ft
3X28	27-3/4"h x 18"d x 15"w	\$839	+\$299	+\$340	+\$275	+\$350	+\$50	+215	45 lb	5.9 ft
3328	34-3/4"h x 18"d x 12"w	\$892	+\$275	+\$340	+\$275	+\$350	+\$50	+210	46 lb	4.3 ft
4X28	34-3/4"h x 18"d x 15"w	\$897	+\$328	+\$340	+\$275	+\$350	+\$50	+215	51 lb	7.3 ft
3P28	39-7/8"h x 18"d x 12"w	\$949	+\$293	+\$340	+\$275	+\$350	+\$50	+210	55 lb	6.5 ft
8P28	39-7/8"h x 24"d x 12"w	\$965	+\$293	+\$340	+\$275	+\$350	+\$50	+210	66 lb	8.8 ft
5X28	39-7/8"h x 18"d x 15"w	\$954	+\$360	+\$340	+\$275	+\$350	+\$50	+215	61 lb	8.3 ft
6X28	39-7/8"h x 24"d x 15"w	\$979	+\$360	+\$340	+\$275	+\$350	+\$50	+215	72 lb	10.7 ft
9P28	39-7/8"h x 18"d x 18"w	\$959	+\$407	+\$340	+\$275	+\$350	+\$50	+225	64 lb	9.7 ft
7P28	39-7/8"h x 24"d x 18"w	\$992	+\$407	+\$340	+\$275	+\$350	+\$50	+225	77 lb	12.6 ft
7M28	51-3/8"h x 18"d x 12"w	\$1,151	+\$333	+\$340	+\$275	+\$350	+\$50	+210	69 lb	8.24 ft
6M28	51-3/8"h x 24"d x 12"w	\$1,205	+\$333	+\$340	+\$275	+\$350	+\$50	+210	83 lb	11 ft
7X28	51-3/8"h x 18"d x 15"w	\$1,156	+\$430	+\$340	+\$275	+\$350	+\$50	+215	75 lb	10.4 ft
8X28	51-3/8"h x 24"d x 15"w	\$1,212	+\$430	+\$340	+\$275	+\$350	+\$50	+215	90 lb	13.6 ft
1P28	51-3/8"h x 18"d x 18"w	\$1,160	+\$439	+\$340	+\$275	+\$350	+\$50	+225	78 lb	12 ft
9N28	51-3/8"h x 24"d x 18"w	\$1,218	+\$439	+\$340	+\$275	+\$350	+\$50	+225	89 lb	16.1 ft
1N28	65-7/8"h x 18"d x 12"w	\$1,180	+\$461	+\$340	+\$275	+\$350	+\$50	+210	82 lb	11 ft
9M28	65-7/8"h x 24"d x 12"w	\$1,233	+\$461	+\$340	+\$275	+\$350	+\$50	+210	100 lb	14.3 ft
9X28	65-7/8"h x 18"d x 15"w	\$1,267	+\$579	+\$340	+\$275	+\$350	+\$50	+215	89 lb	13.4 ft
1Y28	65-7/8"h x 24"d x 15"w	\$1,325	+\$579	+\$340	+\$275	+\$350	+\$50	+215	108 lb	17.4 ft
8N28	65-7/8"h x 18"d x 18"w	\$1,354	+\$608	+\$340	+\$275	+\$350	+\$50	+225	93 lb	15.2 ft
7N28	65-7/8"h x 24"d x 18"w	\$1,418	+\$608	+\$340	+\$275	+\$350	+\$50	+225	112 lb	20.4 ft

Hinge

- L Left
- R Right

Key Locks

See page 11 for available options

Available Fronts

- A Full Pull
- S Satin Nickel Loop
- Q Bar Pull
- E Electronic Locks - see page 46
- V Venting (select A, S, Q pull, or electronic lock)
- M Mail Slot (select A, S, Q pull, or electronic lock)

Note: When selecting E-lock only E or A fronts can be used
E-Lock Mini and RFID are integral pulls on square front only

Paint & Laminate

See Finish Center for available options

Helpful Hint:

See page 56 for E-lock mini and E-lock RFID Key Management accessories



Double Lockers

- Each locker compartment includes (2) two-pronged coat hooks, one per side
- Both doors hinge together, either left or right
- The two locker doors are keyed randomly in the factory
- Optional adjustable shelves may be ordered separately

Part #	Description	Base Price	Laminate Door	E-Lock	E-Lock Mini	E-Lock RFID	Hasp	Slope Top	Pkg Wt	Pkg Cube
3NH7	2 Door 65-7/8"h x 18"d x 12"w	\$1,337	+\$702	+\$680	+\$550	+\$700	+\$100	+210	83 lb	11 ft
2NH7	2-Door 65-7/8"h x 24"d x 12"w	\$1,390	+\$702	+\$680	+\$550	+\$700	+\$100	+210	101 lb	14.3 ft
4YH7	2 Door 65-7/8"h x 18"d x 15"w	\$1,387	+\$808	+\$680	+\$550	+\$700	+\$100	+215	86 lb	13.4 ft
3YH7	2-Door 65-7/8"h x 24"d x 15"w	\$1,442	+\$808	+\$680	+\$550	+\$700	+\$100	+215	106 lb	17.4 ft
2PH7	2 Door 65-7/8"h x 18"d x 18"w	\$1,395	+\$880	+\$680	+\$550	+\$700	+\$100	+225	94 lb	15.2 ft
8SH7	2-Door 65-7/8"h x 24"d x 18"w	\$1,451	+\$880	+\$680	+\$550	+\$700	+\$100	+225	115 lb	20.4 ft

Hinge

- L Left
- R Right

Key Locks

See page 11 for available options

Available Fronts

- A Full Pull
- S Satin Nickel Loop
- Q Bar Pull
- E Electronic Locks - see page 46
- V Venting (select A, S, Q pull, or electronic lock)
- M Mail Slot (select A, S, Q pull, or electronic lock)

Note: When selecting E-lock only E or A fronts can be used
E-Lock Mini and RFID are integral pulls on square front only

Paint & Laminate

See Finish Center for available options

Helpful Hint:

See page 56 for E-lock mini and E-lock RFID Key Management accessories



TRACE Quad Locker

- Quad lockers do not include shelves. If desired, adjustable shelves may be ordered separately
- Each locker compartment includes (2) two-pronged coat hooks, one per side
- The four locker doors are keyed randomly in the factory
- The four locker doors hinge together, either left or right

Part #	Description	Base Price	Lam-inate Door	E-Lock	E-Lock Mini	E-Lock RFID	Hasp	Slope Top	Pkg Wt	Pkg Cube
4NJ7	4 Door 65-7/8"h x 18"d x 24"w	\$1,925	+\$1,404	+\$1360	+\$1100	+\$1400	+\$200	+235	142 lb	11 ft
5NJ7	4 Door 65-7/8"h x 24"d x 24"w	\$2,230	+\$1,404	+\$1360	+\$1100	+\$1400	+\$200	+235	171 lb	25.5 ft
6YJ7	4 Door 65-7/8"h x 18"d x 30"w	\$2,050	+\$1,616	+\$1360	+\$1100	+\$1400	+\$200	+250	155 lb	25.1 ft
5YJ7	4 Door 65-7/8"h x 24"d x 30"w	\$2,375	+\$1,616	+\$1360	+\$1100	+\$1400	+\$200	+250	186 lb	32.7 ft

Hinge

- L** Left
- R** Right

Key Locks

See page 11 for available options

Available Fronts

- A** Full Pull
- S** Satin Nickel Loop
- Q** Bar Pull
- E** Electronic Locks - see page 46
- V** Venting (select A, S, Q pull, or electronic lock)
- M** Mail Slot (select A, S, Q pull, or electronic lock)

Note: When selecting E-lock only E or A fronts can be used
E-Lock Mini and RFID are integral pulls on square front only

Paint & Laminate

See Finish Center for available options

Helpful Hint:

See page 56 for E-lock mini and E-lock RFID Key Management accessories



TRACE Personal Locker

- 18" wide lockers Includes a fixed shelf on top, two adjustable shelves, pull-out hanging file rack, and coat storage
- Coat compartment includes a single two-pronged hook, located on the hinge side of the locker
- Hanging file rack accommodates 8.25 filing inches

Part #	Description	Base Price	Laminate Door	E-Lock	E-Lock Mini	E-Lock RFID	Hasp	Slope Top	Pkg Wt	Pkg Cube
6SS7	1 Door 65-7/8"h x 18"d x 18"w	\$1,416	+ 608	+ \$340	+ \$275	+\$350	+ \$50	+225	115 lb	20.4 ft

Hinge

- L** Left
- R** Right

Key Locks

See page 11 for available options

Available Fronts

- A** Full Pull
- S** Satin Nickel Loop
- Q** Bar Pull
- E** Electronic Locks - see page 46
- V** Venting (select A, S, Q pull, or electronic lock)
- M** Mail Slot (select A, S, Q pull, or electronic lock)

Note: When selecting E-lock only E or A fronts can be used
E-Lock Mini and RFID are integral pulls on square front only

Paint & Laminate

See Finish Center for available options

Helpful Hint:

See page 56 for E-lock mini and E-lock RFID Key Management accessories

Cubby Lockers

- Cubby locker doors are keyed randomly in the factory
- All Cubby locker doors hinge together, either left or right



Part #	Description	Base Price	Laminate Door	E-Lock	E-Lock Mini	E-Lock RFID	Hasp	Slope Top	Pkg Wt	Pkg Cube
6JT7	2-Door Single 34-3/4" h x 18" d x 12" w	\$1,054	+\$476	+\$680	+\$550	+\$700	+\$100	+210	50 lb	5.9 ft
5HT3	3-Door Single 50-3/8" h x 18" d x 12" w	\$1,243	+\$714	+\$1020	+\$825	+\$1050	+\$150	+210	70 lb	8.4 ft
5JT6	4-Door Single 65-7/8" h x 18" d x 12" w	\$1,521	+\$952	+\$1360	+\$1100	+\$1400	+\$200	+210	89 lb	11 ft
7YT7	2-Door Single 34-3/4" h x 18" d x 15" w	\$1,123	+\$542	+\$680	+\$550	+\$700	+\$100	+215	58 lb	7.2 ft
8YT3	3-Door Single 50-3/8" h x 18" d x 15" w	\$1,324	+\$813	+\$1020	+\$825	+\$1050	+\$150	+215	77 lb	10.3 ft
9YT6	4-Door Single 65-7/8" h x 18" d x 15" w	\$1,620	+\$1084	+\$1360	+\$1100	+\$1400	+\$200	+215	96 lb	13.4 ft
9HN7	4-Door Double 34-3/4" h x 18" d x 24" w	\$1,767	+\$952	+\$1360	+\$1100	+\$1400	+\$200	+235	88 lb	11 ft
8HT1	6 Door Double 50-3/8" h x 18" d x 24" w	\$2,171	+\$1,428	+\$2040	+\$1650	+\$2100	+\$300	+235	119 lb	15.7 ft
7HN6	8-Door Double 65-7/8" h x 18" d x 24" w	\$2,643	+\$1,904	+\$2720	+\$2200	+\$2800	+\$400	+235	150 lb	20.5 ft
1ZN7	4-Door Double 34-3/4" h x 18" d x 30" w	\$1,882	+\$1,084	+\$1360	+\$1100	+\$1400	+\$200	+250	99 lb	13.6 ft
2ZT1	6 Door Double 50-3/8" h x 18" d x 30" w	\$2,312	+\$1,626	+\$2040	+\$1650	+\$2100	+\$300	+250	132 lb	19.4 ft
3ZN6	8-Door Double 65-7/8" h x 18" d x 30" w	\$2,815	+\$2,168	+\$2720	+\$2200	+\$2800	+\$400	+250	167 lb	25.1 ft

Hinge

- L Left
- R Right

Key Locks

See page 11 for available options

Available Fronts

- A Full Pull
- S Satin Nickel Loop
- Q Bar Pull
- E Electronic Locks - see page 46
- V Venting (select A, S, Q pull, or electronic lock)
- M Mail Slot (select A, S, Q pull, or electronic lock)

Note: When selecting E-lock only E or A fronts can be used
E-Lock Mini and RFID are integral pulls on square front only

Paint & Laminate

See Finish Center for available options

Helpful Hint:

See page 56 for E-lock mini and E-lock RFID Key Management accessories



Open Cubby Lockers

- When ganging lockers together side-by-side, use the locator holes provided. On both the left and right sides of the locker, two holes are hidden behind the top shelf and two more are hidden beneath removable bottom pan



Part #	Description	Base Price	Slope Top	Pkg Wt	Pkg Cube
COP7RV5	2-Opening Single Wide 34-3/4"h x 18"d x 12"w	\$885	+210	45 lb	5.9 ft
COP5HW3	3-Opening Single Wide 50-3/8"h x 18"d x 12"w	\$995	+210	62 lb	8.4 ft
COP5JW4	4-Opening Single Wide 65-7/8"h x 18"d x 12"w	\$1,186	+210	75 lb	11 ft
COP4ZV5	2-Opening Single Wide 34-3/4"h x 18"d x 15"w	\$943	+215	50 lb	7.2 ft
COP5ZW3	3-Opening Single Wide 50-3/8"h x 18"d x 15"w	\$1,060	+215	66 lb	10.3 ft
COP6ZW4	4-Opening Single Wide 65-7/8"h x 18"d x 15"w	\$1,263	+215	82 lb	13.4 ft
COP9HW5	4-Opening Double Wide 34-3/4"h x 18"d x 24"w	\$1,431	+235	80 lb	11 ft
COP8HW6	6-Opening Double Wide 50-3/8"h x 18"d x 24"w	\$1,672	+235	110 lb	15.7 ft
COP7HW7	8-Opening Double Wide 65-7/8"h x 18"d x 24"w	\$1,983	+235	135 lb	20.5 ft
COP7ZW5	4-Opening Double Wide 34-3/4"h x 18"d x 30"w	\$1,524	+250	83 lb	13.6 ft
COP8ZW6	6-Opening Double Wide 50-3/8"h x 18"d x 30"w	\$1,781	+250	110 lb	19.4 ft
COP9ZW7	8-Opening Double Wide 65-7/8"h x 18"d x 30"w	\$2,112	+250	137 lb	25.1 ft

Paint & Laminate

See Finish Center for available options



Freestanding and Mobile Mini Locker

- Includes one adjustable shelf

Mobile:

- 37mm black casters, two locking and two non-locking, are field-installed
- Includes a counterweight for stability

Part #	Description	Base Price	Laminate Door	E-Lock	E-Lock Mini	E-Lock RFID	Hasp	Pkg Wt	Pkg Cube
8D28	Freestanding 20"h x 18-1/4"d x 10"w	\$797	+ \$101	+ \$340	+ \$275	+\$350	+ \$50	33 lb	3.16 ft
9C28	Mobile 21-3/4"h x 18-1/4"d x 10"w	\$832	+ \$101	+ \$340	+ \$275	+\$350	+ \$50	33 lb	3.16 ft

Hinge

- L** Left
- R** Right

Key Locks

See page 11 for available options

Available Fronts

- A** Full Pull
- S** Satin Nickel Loop
- Q** Bar Pull
- E** Electronic Locks - see page 46
- V** Venting (select A, S, Q pull, or electronic lock)
- M** Mail Slot (select A, S, Q pull, or electronic lock)

Note: When selecting E-lock only E or A fronts can be used
E-Lock Mini and RFID are integral pulls on square front only

Paint & Laminate

See Finish Center for available options

Helpful Hint:

See page 56 for E-lock mini and E-lock RFID Key Management accessories

Locker Accessories

Adjustable Metal Shelves



Part #	Description	Price	Pkg Wt	Pkg Cube
ALT21218	18"D x 12"w Package of 2 with clips	\$212	2.5 lb	1 ft
ALT21224	24"D x 12"w Package of 2 with clips	\$228	4 lb	1.5 ft
ALT21518	18"D x 15"w Package of 2 with clips	\$221	2.5 lb	1 ft
ALT21524	24"D x 15"w Package of 2 with clips	\$239	4 lb	1.5 ft
ALT21818	18"D x 18"w Package of 2 with clips	\$230	3 lb	1.5 ft
ALT21824	24"D x 18"w Package of 2 with clips	\$249	4 lb	1.5 ft
ALT41824	18"D x 12"w Package of 4 with clips	\$262	5 lb	1 ft
ALT42424	24"D x 12"w Package of 4 with clips	\$282	8 lb.	1.5 ft



Locker Bases

Part #	Description	Base Price	Pkg Wt	Pkg Cube
PLN1218	12"W Plinth Base, 9"H x 18"D	\$170	11 lb	1.3 ft
PLN1224	12"W Plinth Base, 9"H x 24"D	\$192	13 lb	1.7 ft
PLN1518	15"W Plinth Base, 9"H x 18"D	\$177	13 lb	1.6 ft
PLN1524	15"W Plinth Base, 9"H x 24"D	\$199	15 lb	2.1 ft
PLN1818	18"W Plinth Base, 9"H x 18"D	\$185	14 lb	1.9 ft
PLN1824	18"W Plinth Base, 9"H x 24"D	\$208	16 lb	2.5 ft
PLN2418	24"W Plinth Base, 9"H x 18"D	\$277	17 lb	2.3 ft
PLN2424	24"W Plinth Base, 9"H x 24"D	\$311	19 lb	3 ft
PLN3018	30"W Plinth Base, 9"H x 18"D	\$292	19 lb	2.8 ft
PLN3024	30"W Plinth Base, 9"H x 24"D	\$329	22 lb	3.8 ft
COPM6P6	12"W Cubby Base, 14-1/2"H x 18"D	\$482	24 lb	2.4 ft
COPM5P6	15"W Cubby Base, 14-1/2H x 18"D	\$513	26 lb	2.9 ft
COPM7P6	24"W Cubby Base, 14-1/2H x 18"D	\$546	32 lb	4.5 ft
COPM8P6	30"W Cubby Base, 14-1/2H x 18"D	\$582	37 lb	5.5 ft



E-Lock Mini and E-Lock RFID Accessories

Part #	Description	Price
DGI0001	Programming Key	\$190
DGI0002	Manager Key	\$139
DGI0005	5 pk RFID Cards	\$174
DGI0025	25 pk RFID Cards	\$870
DGI0100	100 pk RFID Cards	\$3480



TRACE Locker Ganging Kit

- Ganging kit is used to snug two lockers together so that between-locker seams stay tight
- Ganging kit includes drill point screws and instructions

Part #	Description	Price	Pkg Wt	Pkg Cube
LCK00025K	Kit to gang two lockers together	\$47	1 lb	.2 ft

Locker Door Number Plates



- .030 Acrylic 1" h x 2"w, surface color brushed aluminum
- Imprinted in black with any combination of numbers needed to permanently identify individual locker doors
- Includes a peel-and-stick adhesive (3M #467MP 5 mil PSA) that provides a permanent attachment to metal and laminate
- Shipped separately from your locker order. Once lockers are set in place, the number plates may then be installed in the desired order
- Please specify the quantity and number pattern needed. No minimum order required
- If desired, number plates may also be ordered direct from our supplier. Call us for their contact information



Part #	Description	Price per unit
LDNP0012	Brushed aluminum number plate 2" W x 1" H	\$15

Basic Construction

- All Great Openings products meet or exceed applicable ANSI-BIFMA standards for durability and safety
- A 12 year warranty ensures long-lasting performance and after-sale support
- Leveling glides allow for 7/8" adjustment and are accessible from inside the locker
- Concealed door hinges allow for 100 degree opening
- The front-facing kick plate on laminate lockers is 3.25"

Features

- 18" deep lockers include (2) two-pronged coat hooks, one per side
- All single door lockers include two clusters of shelf clip holes in the side panels, to accommodate additional shelves that are sold separately. One cluster near the top of the locker allows for 3" adjustability, with up to 12" clear height above the shelf. A second cluster near the bottom of the locker allows for 3" adjustability, with up to 8" clear height below the shelf
- Additional adjustable shelves are available for order on most locker styles
- Door may hinge left or right
- Lockers available with three lock options: keyed (UM is standard, and also available with LL, SL), Hasp, and electronic locks
- Conventional keyed lockers are keyed randomly at the factory. Key alike service is available

Options and Accessories

- Locker door number plates
- Common laminate tops

Keyed Locks

- Lockers come standard with randomly-assigned UM Series lockers (#226-425)
- UM locks are black-faced, master-keyed and core-removable
- You may arrange with Customer Service to have these locks keyed-alike in the field
- Other key series options are available, including bright nickel LL, Haworth SL

Hasp Locks

- Hasp locks may be used instead of a keyed or electronic lock
- To order, specify "Hasp Lock" in the product description on your purchase order and add \$50 list per door to the keyed locker price

Cleaning Laminate

This guide provides specific information to keep your Great Openings and Sparkeology products like new. With proper care, you can expect years of trouble-free use.

1. Apply a vinegar-and-water solution to a paper towel or a clean, lint-free microfiber cloth.
2. Gently wipe the surface to remove any surface dust. **Caution:** do not use furniture polish that contains waxes and oils on laminate surfaces. Do not use bleached-based cleaners on laminate as it may discolor. Do not use hard bristle brushes that may scratch the surface.
3. To spot clean laminate, use a mild soap-and-water solution or Windex®.
4. Rub the soiled area in the direction of the grain. If no grain is present, rub in a circular motion.



E-Lock

E-Lock (E)

- Durable and versatile, electronic locks may be programmed to either fixed or revolving mode
- Fixed Mode: Once a code is created, that code remains in effect until the user changes it. To lock and unlock, simply enter the code and then turn the lever
- Revolving Mode: Also called hoteling or single use mode, the code is cleared after each complete locking cycle. To lock: enter a code and then turn the lever. To unlock: enter the same code and turn the lever. At this point the lock clears the code and is awaiting new input
- Electronic Lock Features:
 - Once a code is entered, the lock is activated by turning the lever to the locked or unlocked position
 - Runs on (2) AAA batteries (included)
 - Operates using a 4-to-8 digit code
 - A supervisor code is included
 - For large projects, the supervisor code may be pre-programmed into the locks
 - May be programmed by the supervisor as Fixed or Revolving Code
 - Includes programmable reset features
 - Easy to clean membrane keypad
 - 75,000 plus cycles; extended battery life reduces replacement and labor maintenance costs
- 1 year warranty



E-Lock Mini Keypad

E-Lock Mini Keypad (VM)

- Keypad operation
- Cam locking mechanism
- Manage with electronic keys
- Dual functionality – shared or assigned use
- Management override and power bypass
- All metal housing
- Brushed nickel finish
- Vertical orientation – knob on the top
- Visual and audible indicators
- Available with advanced features*
 - Mobile app management
 - Audit trail
 - Advanced auto unlock feature
 - Advanced system tools
- IP55 rated, FCC, CE, and CI certified
- ADA compliant models available
- Powered by 2 lithium CR2450 batteries
- Battery Life: 180,000 cycles with average use
- 2 year warranty



E-Lock Mini RFID

E-Lock Mini RFID (RM)

- Touch RFID operation
- RFID standards - iClass and Mifare (13.56 MHz) ISO 14443A • ISO 14443B • ISO 15693
- Cam locking mechanism
- Manage with electronic keys
- Shared or assigned use
- Management override and power bypass
- All metal housing
- Brushed nickel finish
- Vertical orientation knob on the top
- Visual and audible indicators
- Available with advanced features*
 - Mobile app management
 - Audit trail
 - Advanced auto unlock feature
 - Advanced system tools
- IP55 rated, FCC, CE, and CI certified
- ADA compliant models available
- Powered by 4 premium AA batteries
- Battery Life: 115,000 cycles with average use
- 2 year warranty

Helpful Hint:

See page 66 for E-lock mini and E-lock RFID Key Management accessories

Standard Door Pulls



S – Satin Nickel Loop Pull Square Front



Q – Bar Pull Square Front

E-Lock Door Pulls



E-Lock Square Front



E-Lock Mini Keypad Square Front



E-Lock Mini RFID Square Front

TRACE Laminate Locker Inside Dimensions (in inches)

Description	Interior Dimension Per/Locker Opening					
	Height	Width			Depth	
		12" W	15" W	18" W	18" D	24" D
Single Lockers						
Single Locker 27-3/4"H	23.750	10.580"	13.580"	16.580"	17.156"	23.156
Single Locker 34-3/4"H	30.750	10.580"	13.580"	16.580"	17.156"	23.156
Single Locker 39-7/8"H	35.875"	10.580"	13.580"	16.580"	17.156"	23.156
Single Locker 51-3/8" H	47.375"	10.580"	13.580"	16.580"	17.156"	23.156
Single Locker 65-7/8"H	61.875"	10.580"	13.580"	16.580"	17.156"	23.156
Above Shelf	12.000"	10.580"	13.580"	16.580"	17.156"	23.156
Double Lockers						
Top Locker	30.828"	10.580"	13.580"	16.580"	17.156"	23.156
Bottom Locker	30.279"	10.580"	13.580"	16.580"	17.156"	23.156
Quad Lockers						
Top Lockers	30.828"	10.580"	13.580"		17.156"	23.156
Bottom Lockers	30.279"	10.580"	13.580"		17.156"	23.156
Cubby Lockers						
All Cubbies	14.750"	10.580"	13.580"		17.156"	
Personal Locker						
Personal Locker	61.875"				17.156"	
Above Shelf	12.000"					



Laminate Single Lockers

- 27-3/4" high lockers include one adjustable shelf, but no coat rod or hooks
- 34-3/4" high locker includes coat hook and slots for adjustable shelves
- 39-7/8" high lockers include coat hooks or rods and optional shelves
- 51-3/8" and 65-7/8" high lockers include one adjustable shelf on top, with up to 12" clear height above the shelf
- The 18" deep lockers include (2) two-pronged coat hooks, one on each side. The 24" deep lockers include (1) side-to-side coat rod

Part #	Description	Base TFL Price	Base HPL Price	E-Lock	E-Lock Mini	E-Lock RFID	Hasp	Pkg Wt	Pkg Cube
W4R28	27-3/4"h x 18"d x 12"w	\$1,084	\$1,331	+\$340	+\$275	+\$350	+\$50	40 lb	3.9 ft
W3X28	27-3/4"h x 18"d x 15"w	\$1,215	\$1,562	+\$340	+\$275	+\$350	+\$50	45 lb	5.9 ft
W3328	34-3/4"h x 18"d x 12"w	\$1,145	\$1,383	+\$340	+\$275	+\$350	+\$50	46 lb	4.3 ft
W4X28	34-3/4"h x 18"d x 15"w	\$1,284	\$1,632	+\$340	+\$275	+\$350	+\$50	51 lb	7.3 ft
W3P28	39-7/8"h x 18"d x 12"w	\$1,187	\$1,444	+\$340	+\$275	+\$350	+\$50	55 lb	6.5 ft
W8P28	39-7/8"h x 24"d x 12"w	\$1,207	\$1,470	+\$340	+\$275	+\$350	+\$50	66 lb	8.8 ft
W5X28	39-7/8"h x 18"d x 15"w	\$1,193	\$1,478	+\$340	+\$275	+\$350	+\$50	61 lb	8.3 ft
W6X28	39-7/8"h x 24"d x 15"w	\$1,223	\$1,516	+\$340	+\$275	+\$350	+\$50	72 lb	10.7 ft
W9P28	39-7/8"h x 18"d x 18"w	\$1,199	\$1,512	+\$340	+\$275	+\$350	+\$50	64 lb	9.7 ft
W7P28	39-7/8"h x 24"d x 18"w	\$1,239	\$1,562	+\$340	+\$275	+\$350	+\$50	77 lb	12.6 ft
W7M28	51-3/8"h x 18"d x 12"w	\$1,439	\$1,751	+\$340	+\$275	+\$350	+\$50	69 lb	8.24 ft
W6M28	51-3/8"h x 24"d x 12"w	\$1,505	\$1,832	+\$340	+\$275	+\$350	+\$50	83 lb	11 ft
W7X28	51-3/8"h x 18"d x 15"w	\$1,445	\$1,790	+\$340	+\$275	+\$350	+\$50	75 lb	10.4 ft
W8X28	51-3/8"h x 24"d x 15"w	\$1,514	\$1,876	+\$340	+\$275	+\$350	+\$50	90 lb	13.6 ft
W1P28	51-3/8"h x 18"d x 18"w	\$1,450	\$1,829	+\$340	+\$275	+\$350	+\$50	78 lb	12 ft
W9N28	51-3/8"h x 24"d x 18"w	\$1,523	\$1,919	+\$340	+\$275	+\$350	+\$50	89 lb	16.1 ft
W1N28	65-7/8"h x 18"d x 12"w	\$1,475	\$1,796	+\$340	+\$275	+\$350	+\$50	82 lb	11 ft
W9M28	65-7/8"h x 24"d x 12"w	\$1,657	\$1,877	+\$340	+\$275	+\$350	+\$50	100 lb	14.3 ft
W9X28	65-7/8"h x 18"d x 15"w	\$1,584	\$1,836	+\$340	+\$275	+\$350	+\$50	89 lb	13.4 ft
W1Y28	65-7/8"h x 24"d x 15"w	\$1,715	\$2,056	+\$340	+\$275	+\$350	+\$50	108 lb	17.4 ft
W8N28	65-7/8"h x 18"d x 18"w	\$1,693	\$2,136	+\$340	+\$275	+\$350	+\$50	93 lb	15.2 ft
W7N28	65-7/8"h x 24"d x 18"w	\$1,772	\$2,235	+\$340	+\$275	+\$350	+\$50	112 lb	20.4 ft

Hinge

- L Left
- R Right

Key Locks

See page 11 for available options

Available Fronts

- S Satin Nickel Loop
- Q Bar Pull
- E Electronic Locks - see page 58

Note: When selecting E-lock only E fronts can be used

Paint & Laminate

See Finish Center for available options

Helpful Hint:

See page 66 for E-lock mini and E-lock RFID Key Management accessories



Laminate Double Door Lockers

- Each locker compartment includes (2) two-pronged coat hooks, one per side
- Both doors hinge together, either left or right
- The two locker doors are keyed randomly in the factory
- Optional adjustable shelves may be ordered separately

Part #	Description	Base TFL Price	Base HPL Price	E-Lock	E-Lock Mini	E-Lock RFID	Hasp	Pkg Wt	Pkg Cube
W3NH7	2 Door 65-7/8"h x 18"d x 12"w	\$1,697	\$2,066	+\$680	+\$550	+\$700	+\$100	83 lb	11 ft
W2NH7	2-Door 65-7/8"h x 24"d x 12"w	\$1,764	\$2,147	+\$680	+\$550	+\$700	+\$100	101 lb	14.3 ft
W4YH7	2 Door 65-7/8"h x 18"d x 15"w	\$1,734	\$2,149	+\$680	+\$550	+\$700	+\$100	86 lb	13.4 ft
W3YH7	2-Door 65-7/8"h x 24"d x 15"w	\$1,802	\$2,234	+\$680	+\$550	+\$700	+\$100	106 lb	17.4 ft
W2PH7	2 Door 65-7/8"h x 18"d x 18"w	\$1,770	\$2,232	+\$680	+\$550	+\$700	+\$100	94 lb	15.2 ft
W8SH7	2-Door 65-7/8"h x 24"d x 18"w	\$1,840	\$2,320	+\$680	+\$550	+\$700	+\$100	115 lb	20.4 ft

Hinge

- L** Left
- R** Right

Key Locks

See page 11 for available options

Available Fronts

- S** Satin Nickel Loop
- Q** Bar Pull
- E** Electronic Locks - see page 58

Note: When selecting E-lock only E fronts can be used

Paint & Laminate

See Finish Center for available options

Helpful Hint:

See page 66 for E-lock mini and E-lock RFID Key Management accessories



Laminate Quad Lockers

- Quad lockers do not include shelves. If desired, adjustable shelves may be ordered separately
- Each locker compartment includes (2) two-pronged coat hooks, one per side
- The four locker doors are keyed randomly in the factory
- The four locker doors hinge together, either left or right

Part #	Description	Base TFL Price	Base HPL Price	E-Lock	E-Lock Mini	E-Lock RFID	Hasp	Pkg Wt	Pkg Cube
W4NJ7	4 Door 65-7/8"h x 18"d x 24"w	\$2,407	\$2,930	+\$1360	+\$1100	+\$1400	+\$200	142 lb	11 ft
W5NJ7	4 Door 65-7/8"h x 24"d x 24"w	\$2,614	\$3,574	+\$1360	+\$1100	+\$1400	+\$200	171 lb	25.5 ft
W6YJ7	4 Door 65-7/8"h x 18"d x 30"w	\$2,750	\$3,951	+\$1360	+\$1100	+\$1400	+\$200	155 lb	25.1 ft
W5YJ7	4 Door 65-7/8"h x 24"d x 30"w	\$2,848	\$4,159	+\$1360	+\$1100	+\$1400	+\$200	186 lb	32.7 ft

Hinge

- L Left
- R Right

Key Locks

See page 11 for available options

Available Fronts

- S Satin Nickel Loop
- Q Bar Pull
- E Electronic Locks - see page 58

Note: When selecting E-lock only E fronts can be used

Paint & Laminate

See Finish Center for available options

Helpful Hint:

See page 66 for E-lock mini and E-lock RFID Key Management accessories

Laminate Cubby Lockers

- Cubby locker doors are keyed randomly in the factory
- All Cubby locker doors hinge together, either left or right



Part #	Description	Base TFL Price	Base HPL Price	E-Lock	E-Lock Mini	E-Lock RFID	Hasp	Pkg Wt	Pkg Cube
W6JT7	2-Door Single 34-3/4"h x 18"d x 12"w	\$1,317	\$1,604	+\$680	+\$550	+\$700	+\$100	50 lb	5.9 ft
W5HT3	3-Door Single 50-3/8"h x 18"d x 12"w	\$1,554	\$1,892	+\$1020	+\$825	+\$1050	+\$150	70 lb	8.4 ft
W5JT6	4-Door Single 65-7/8"h x 18"d x 12"w	\$1,901	\$2,314	+\$1360	+\$1100	+\$1400	+\$200	89 lb	11 ft
W7YT7	2-Door Single 34-3/4"h x 18"d x 15"w	\$1,493	\$1,841	+\$680	+\$550	+\$700	+\$100	58 lb	7.2 ft
W8YT3	3-Door Single 50-3/8"h x 18"d x 15"w	\$1,841	\$2,118	+\$1020	+\$825	+\$1050	+\$150	77 lb	10.3 ft
W9YT6	4-Door Single 65-7/8"h x 18"d x 15"w	\$2,145	\$2,743	+\$1360	+\$1100	+\$1400	+\$200	96 lb	13.4 ft
W9HN7	4-Door Double 34-3/4"h x 18"d x 24"w	\$1,940	\$2,498	+\$1360	+\$1100	+\$1400	+\$200	88 lb	11 ft
W8HT1	6 Door Double 50-3/8"h x 18"d x 24"w	\$2,383	\$3,068	+\$2040	+\$1650	+\$2100	+\$300	119 lb	15.7 ft
W7HN6	8-Door Double 65-7/8"h x 18"d x 24"w	\$2,891	\$3,736	+\$2720	+\$2200	+\$2800	+\$400	150 lb	20.5 ft
W1ZN7	4-Door Double 34-3/4"h x 18"d x 30"w	\$2,028	\$2,548	+\$1360	+\$1100	+\$1400	+\$200	99 lb	13.6 ft
W2ZT1	6 Door Double 50-3/8"h x 18"d x 30"w	\$2,723	\$3,389	+\$2040	+\$1650	+\$2100	+\$300	132 lb	19.4 ft
W3ZN6	8-Door Double 65-7/8"h x 18"d x 30"w	\$2,952	\$4,215	+\$2720	+\$2200	+\$2800	+\$400	167 lb	25.1 ft

Hinge

- L Left
- R Right

Key Locks

See page 11 for available options

Available Fronts

- S Satin Nickel Loop
- Q Bar Pull
- E Electronic Locks - see page 58

Note: When selecting E-lock only E fronts can be used

Paint & Laminate

See Finish Center for available options

Helpful Hint:

See page 66 for E-lock mini and E-lock RFID Key Management accessories

TRACE LAMINATE LOCKERS



Open Cubby Lockers

- When ganging lockers together side-by-side, use the locator holes provided. On both the left and right sides of the locker, two holes are hidden behind the top shelf and two more are hidden beneath removable bottom pan

Part #	Description	Base TFL Price	Base HPL Price	Pkg Wt	Pkg Cube
WCOP7RV5	2-Opening Single Wide 34-3/4"h x 18"d x 12"w	\$1,111	\$1,370	45 lb	5.9 ft
WCOP5HW3	3-Opening Single Wide 50-3/8"h x 18"d x 12"w	\$1,258	\$1,573	62 lb	8.4 ft
WCOP5JW4	4-Opening Single Wide 65-7/8"h x 18"d x 12"w	\$1,461	\$1,854	75 lb	11 ft
WCOP4ZV5	2-Opening Single Wide 34-3/4"h x 18"d x 15"w	\$1,243	\$1,520	50 lb	7.2 ft
WCOP5ZW3	3-Opening Single Wide 50-3/8"h x 18"d x 15"w	\$1,347	\$1,729	66 lb	10.3 ft
WCOP6ZW4	4-Opening Single Wide 65-7/8"h x 18"d x 15"w	\$1,770	\$1,979	82 lb	13.4 ft
WCOP9HW5	4-Opening Double Wide 34-3/4"h x 18"d x 24"w	\$1,622	\$2,071	80 lb	11 ft
WCOP8HW6	6-Opening Double Wide 50-3/8"h x 18"d x 24"w	\$1,894	\$2,588	110 lb	15.7 ft
WCOP7HW7	8-Opening Double Wide 65-7/8"h x 18"d x 24"w	\$2,261	\$3,111	135 lb	20.5 ft
WCOP7ZW5	4-Opening Double Wide 34-3/4"h x 18"d x 30"w	\$1,667	\$2,118	83 lb	13.6 ft
WCOP8ZW6	6-Opening Double Wide 50-3/8"h x 18"d x 30"w	\$1,878	\$2,882	110 lb	19.4 ft
WCOP9ZW7	8-Opening Double Wide 65-7/8"h x 18"d x 30"w	\$2,292	\$3,188	137 lb	25.1 ft

Laminate

See Finish Center for available options

Laminate Locker Accessories

Adjustable Laminate Shelves

Part #	Description	Base TFL Price	Base HPL Price	Pkg Wt	Pkg Cube
WALT21218	18"D x 12"w Package of 2 with clips	\$265	\$306	2.5 lb	1 ft
WALT21224	24"D x 12"w Package of 2 with clips	\$285	\$329	4 lb	1.5 ft
WALT21518	18"D x 15"w Package of 2 with clip	\$277	\$319	2.5 lb	1 ft
WALT21524	24"D x 15"w Package of 2 with clips	\$298	\$343	4 lb	1.5 ft
WALT21818	18"D x 18"w Package of 2 with clips	\$288	\$332	3 lb	1.5 ft
WALT21824	24"D x 18"w Package of 2 with clips	\$311	\$358	4 lb	1.5 ft

RFID Accessories



Part #	Description	Price
DGI0001	Programming Key	\$190
DGI0002	Manager Key	\$139
DGI0005	5 pk RFID Cards	\$174
DGI0025	25 pk RFID Cards	\$870
DGI0100	100 pk RFID Cards	\$3480

Laminate Locker Ganging Kit



- Ganging kit is used to snug two lockers together so that between-locker seams stay tight
- Ganging kit includes drill point screws and instructions

Part #	Description	Price	Pkg Wt	Pkg Cube
WLCK00025K	Kit to gang two lockers together	\$47	1 lb	.2 ft

Common Laminate Tops

- Laminate tops ordered separately for field installation
- Specify any standard GO laminate or special ordered laminate
- Top sizes allow for 1/8" overhang on all sides
- Common laminate tops will sit on top of locker's metal tops

Laminate Top for Side-by-Side Lockers



Part #	Description	W	D	Price	Pkg Wt	Pkg Cube
LK 1848	(4) 12" wide x 18" deep lockers	48.50	18.25	\$426	38 lb	.7 ft
LK 1854	(3) 18" wide x 18" deep lockers	54.43	18.25	\$496	42 lb	.8 ft
LK 1860	(5) 12" wide x 18" deep lockers	60.56	18.25	\$502	46 lb	.9 ft
LK 2448	(4) 12" wide x 24" deep lockers	48.50	24.25	\$487	41 lb	x ft
LK 2454	(3) 18" wide x 24" deep lockers	54.43	24.25	\$566	45 lb	x ft
LK 2460	(5) 12" wide x 24" deep lockers	60.56	24.25	\$577	50 lb	x ft

Laminate Top for Side-by-Side Double Wide Cubby Lockers



Part #	Description	W	D	Price	Pkg Wt	Pkg Cube
LK 1848	(2) 24" wide x 18" deep lockers	48.50	18.25	\$426	38 lb	.7 ft
LK 1872	(3) 24" wide x 18" deep lockers	72.43	18.25	\$680	64 lb	1.3 ft
LK 1896	(4) 24" wide x 18" deep lockers	96.50	18.25	\$798	95 lb	1.6 ft

Laminate Top for Side-by-Side Open Lockers

- Open Shelf Cubby Lockers require a different size laminate top because they have no doors



Part #	Description	W	D	Price	Pkg Wt	Pkg Cube
LK 1724	(2) 12" wide x 18" deep open cubby lockers (no doors)	24.37	17.50	\$296	19 lb	.5 ft
LK 1748	(4) 12" wide x 18" deep open cubby lockers (no doors)	48.50	17.50	\$421	38 lb	.7 ft
LK 1760	(5) 12" wide x 18" deep open cubby lockers (no doors)	60.56	17.50	\$497	46 lb	.9 ft
LK 1796	(4) 24" wide x 18" deep open cubby lockers (no doors)	96.50	17.50	\$792	95 lb	1.6 ft

Laminate Top for Side-by-Side Double Wide Open Cubby Lockers



Part #	Description	W	D	Price	Pkg Wt	Pkg Cube
LK 1748	(2) 24" wide x 18" deep open cubby lockers (no doors)	48.50	17.50	\$421	41 lb	.8 ft
LK 1772	(3) 24" wide x 18" deep open cubby lockers (no doors)	72.43	17.50	\$675	64 lb	1.3 ft
LK 1796	(4) 24" wide x 18" deep open cubby lockers (no doors)	96.50	17.50	\$792	95 lb	1.6 ft

Laminate Top for Bar-Height Island with Lockers

- 39-7/8" h lockers with 12" overhang and Sly chair. Sides and front overhang 1/8"



Part #	Description	W	D	Price	Pkg Wt	Pkg Cube
LK 3048	(4) 12" wide x 18" deep lockers (includes 12" overhang in back)	48.25	30.25	\$546	51 lb	1.0 ft
LK 3054	(3) 18" wide x 18" deep lockers (includes 12" overhang in back)	54.25	30.25	\$635	58 lb	1.2 ft
LK 3060	(5) 12" wide x 18" deep lockers (includes 12" overhang in back)	60.25	30.25	\$652	63 lb	1.4 ft

trace SINGLE DOOR LOCKER
MULTIPLE COLOR DOOR INDICATION FORM



Use this form to indicate what custom colors you would like on your Single Door Locker. Use additional forms if needed for different color configurations.

1. Use the diagram below to indicate (type or write in) which colors go on which doors and case.
2. Email this form along with your purchase order to customer service at goorders@greatopenings.com.

Calculating Multiple Color Paint Charges:

For each unique cabinet, add \$55 net per additional color beyond the case color. When ordering multiple cabinets that are identical in color pattern, the \$55 net per additional color is applied just once.

Example:

Case Color plus 1 additional color

\$55 net

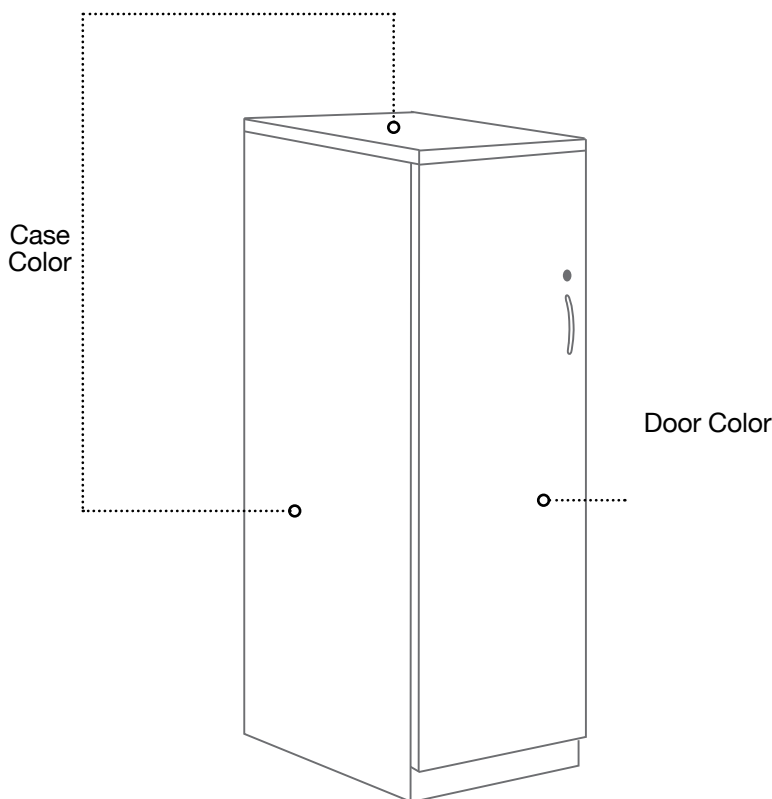

DOUBLE DOOR LOCKER
trace MULTIPLE COLOR DOOR INDICATION FORM



Use this form to indicate what custom colors you would like on your Double Door Locker. Use additional forms if needed for different color configurations.

1. Use the diagram below to indicate (type or write in) which colors go on which doors and case.
2. Email this form along with your purchase order to customer service at goorders@greatopenings.com.

Calculating Multiple Color Paint Charges:

For each unique cabinet, add \$55 net per additional color beyond the case color. When ordering multiple cabinets that are identical in color pattern, the \$55 net per additional color is applied just once.

Example:

Case Color plus 1 additional color	\$55 net
Case Color plus 2 additional colors	\$110 net

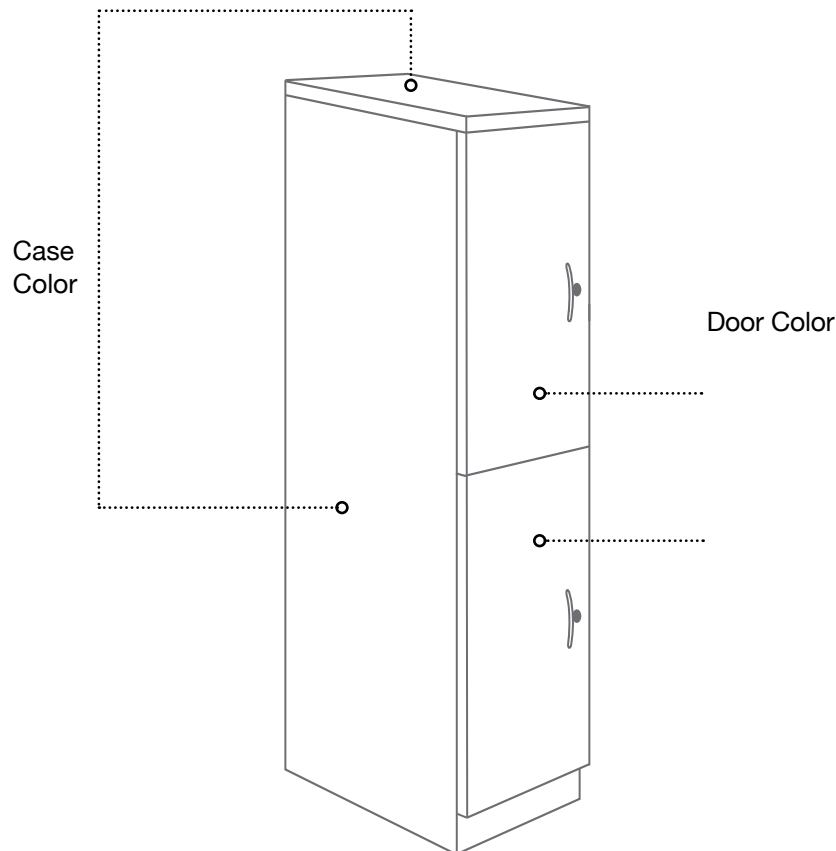

trace **QUAD LOCKER**
MULTIPLE COLOR DOOR INDICATION FORM



Use this form to indicate what custom colors you would like on your Quad Locker. Use additional forms if needed for different color configurations.

1. Use the diagram below to indicate (type or write in) which colors go on which doors and case.
2. Email this form along with your purchase order to customer service at goorders@greatopenings.com.

Calculating Multiple Color Paint Charges:

For each unique cabinet, add \$55 net per additional color beyond the case color. When ordering multiple cabinets that are identical in color pattern, the \$55 net per additional color is applied just once.

Example:	
Case Color plus 1 additional color	\$55 net
Case Color plus 2 additional colors	\$110 net
Case Color plus 3 additional colors	\$165 net
Case Color plus 4 additional colors	\$220 net

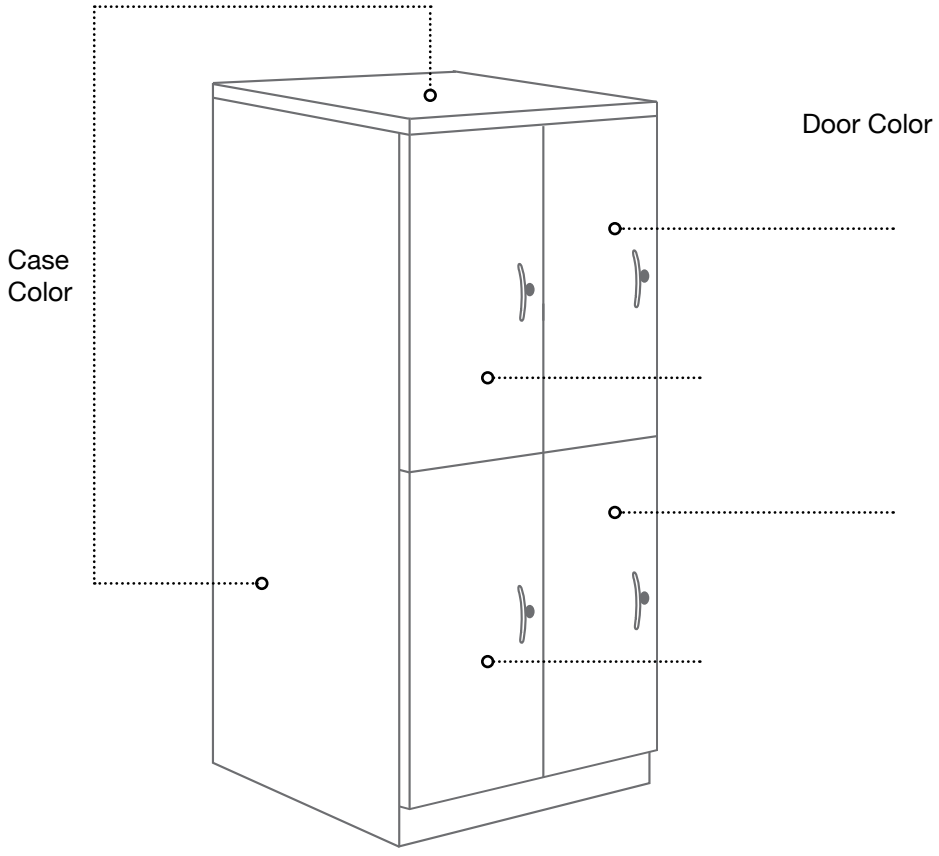

trace SINGLE WIDE 2-DOOR CUBBY LOCKER
MULTIPLE COLOR DOOR INDICATION FORM



Use this form to indicate what custom colors you would like on your Single Wide 2-Door Cubby locker. Use additional forms if needed for different color configurations.

1. Use the diagram below to indicate (type or write in) which colors go on which doors and case.
2. Email this form along with your purchase order to customer service at goorders@greatopenings.com.

Calculating Multiple Color Paint Charges:

For each unique cabinet, add \$55 net per additional color beyond the case color. When ordering multiple cabinets that are identical in color pattern, the \$55 net per additional color is applied just once.

Example:

Case Color plus 1 additional color	\$55 net
Case Color plus 2 additional colors	\$110 net

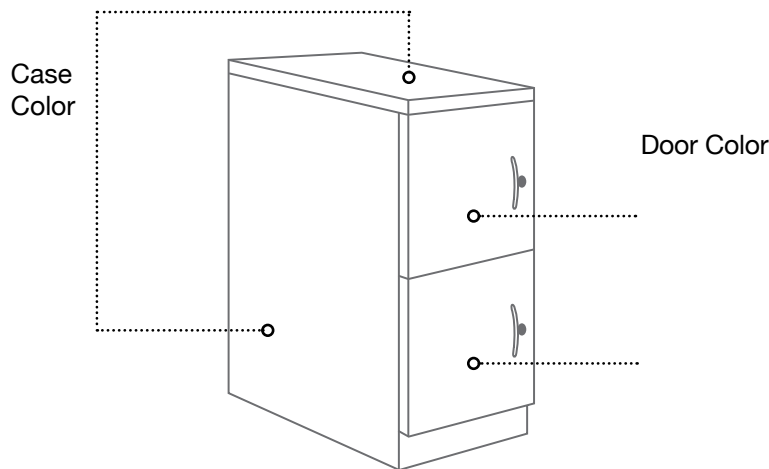

trace SINGLE WIDE 3-DOOR CUBBY LOCKER
MULTIPLE COLOR DOOR INDICATION FORM



Use this form to indicate what custom colors you would like on your Single Wide 3-Door Cubby locker. Use additional forms if needed for different color configurations.

1. Use the diagram below to indicate (type or write in) which colors go on which doors and case.
2. Email this form along with your purchase order to customer service at goorders@greatopenings.com.

Calculating Multiple Color Paint Charges:

For each unique cabinet, add \$55 net per additional color beyond the case color. When ordering multiple cabinets that are identical in color pattern, the \$55 net per additional color is applied just once.

Example:	
Case Color plus 1 additional color	\$55 net
Case Color plus 2 additional colors	\$110 net
Case Color plus 3 additional colors	\$165 net

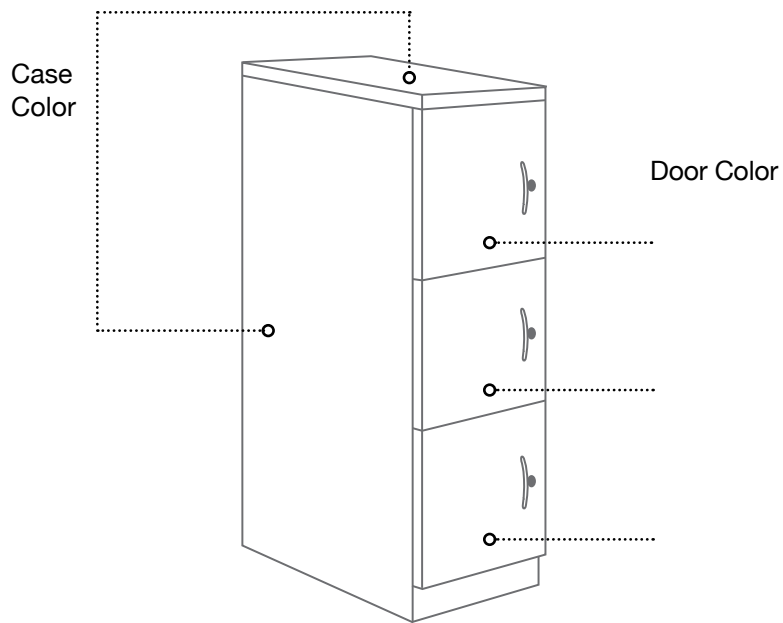

SINGLE WIDE 4-DOOR CUBBY LOCKER
trace MULTIPLE COLOR DOOR INDICATION FORM



Use this form to indicate what custom colors you would like on your Single Wide 4-Door Cubby locker. Use additional forms if needed for different color configurations.

1. Use the diagram below to indicate (type or write in) which colors go on which doors and case.
2. Email this form along with your purchase order to customer service at goorders@greatopenings.com.

Calculating Multiple Color Paint Charges:

For each unique cabinet, add \$55 net per additional color beyond the case color. When ordering multiple cabinets that are identical in color pattern, the \$55 net per additional color is applied just once.

Example:	
Case Color plus 1 additional color	\$55 net
Case Color plus 2 additional colors	\$110 net
Case Color plus 3 additional colors	\$165 net
Case Color plus 4 additional colors	\$220 net

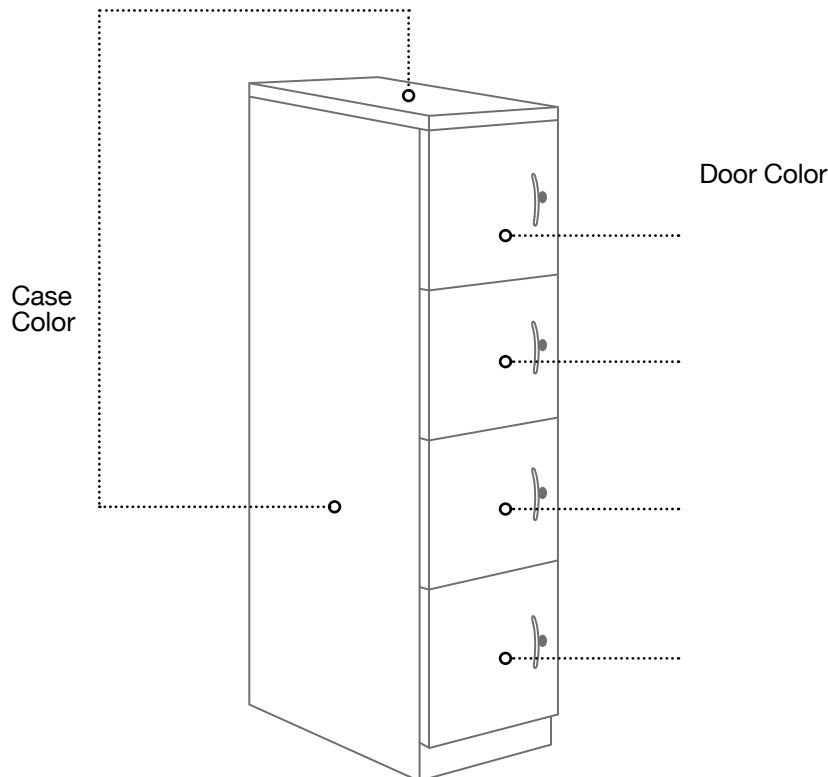

DOUBLE WIDE 4-DOOR CUBBY LOCKER
trace MULTIPLE COLOR DOOR INDICATION FORM



Use this form to indicate what custom colors you would like on your Double Wide 4-Door Cubby Locker. Use additional forms if needed for different color configurations.

1. Use the diagram below to indicate (type or write in) which colors go on which doors and case.
2. Email this form along with your purchase order to customer service at goorders@greatopenings.com.

Calculating Multiple Color Paint Charges:

For each unique cabinet, add \$55 net per additional color beyond the case color. When ordering multiple cabinets that are identical in color pattern, the \$55 net per additional color is applied just once.

Example:	
Case Color plus 1 additional color	\$55 net
Case Color plus 2 additional colors	\$110 net
Case Color plus 3 additional colors	\$165 net
Case Color plus 4 additional colors	\$220 net

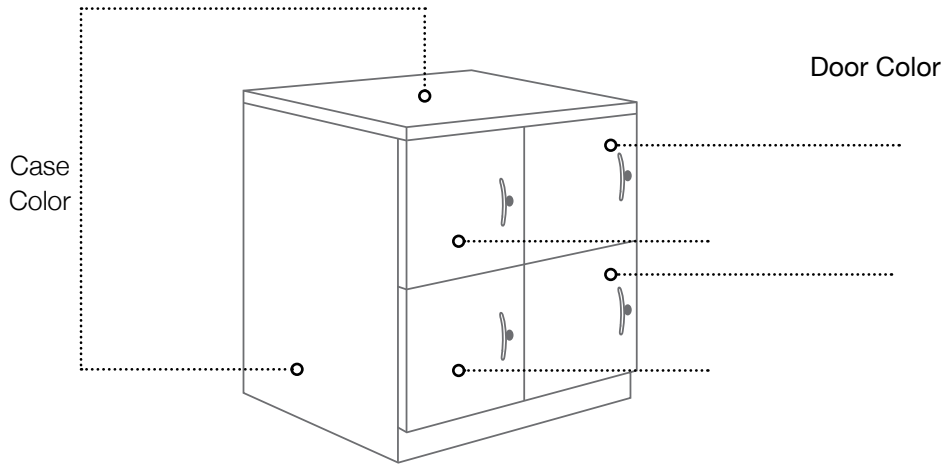

DOUBLE WIDE 6-DOOR CUBBY LOCKER
trace MULTIPLE COLOR DOOR INDICATION FORM



Use this form to indicate what custom colors you would like on your Double Wide 6-Door Cubby Locker. Use additional forms if needed for different color configurations.

1. Use the diagram below to indicate (type or write in) which colors go on which doors and case.
2. Email this form along with your purchase order to customer service at goorders@greatopenings.com.

Calculating Multiple Color Paint Charges:

For each unique cabinet, add \$55 net per additional color beyond the case color. When ordering multiple cabinets that are identical in color pattern, the \$55 net per additional color is applied just once.

Example:

Case Color plus 1 additional color	\$55 net
Case Color plus 2 additional colors	\$110 net
Case Color plus 3 additional colors	\$165 net
Case Color plus 4 additional colors	\$220 net
Case Color plus 5 additional colors	\$275 net
Case Color plus 6 additional colors	\$330 net

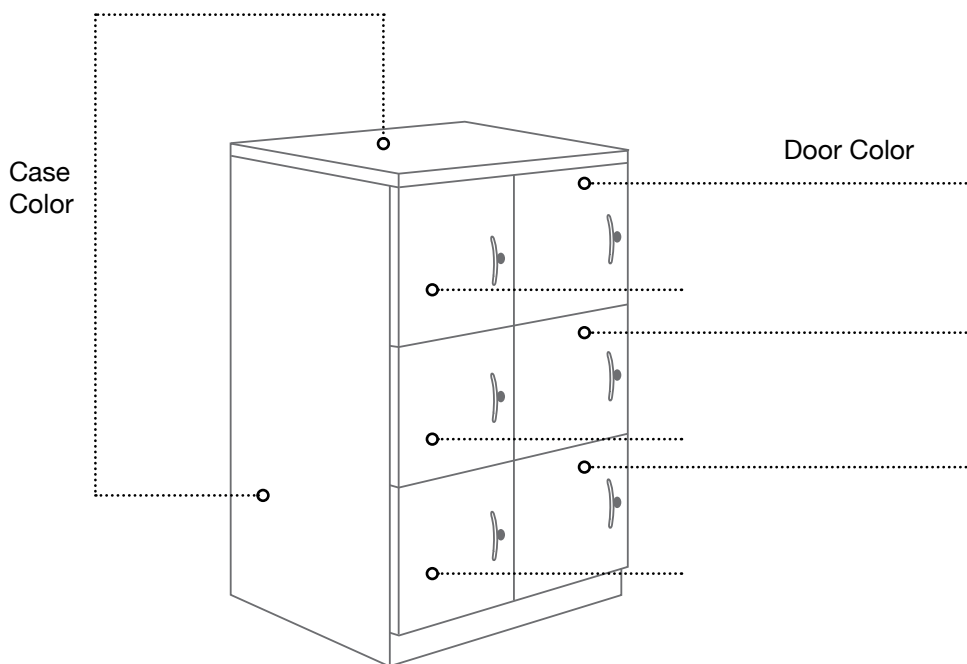

DOUBLE WIDE 8-DOOR CUBBY LOCKER
MULTIPLE COLOR DOOR INDICATION FORM



Use this form to indicate what custom colors you would like on your Double Wide 8-Door Cubby Locker. Use additional forms if needed for different color configurations.

1. Use the diagram below to indicate (type or write in) which colors go on which doors and case.
2. Email this form along with your purchase order to customer service at goorders@greatopenings.com.

Calculating Multiple Color Paint Charges:

For each unique cabinet, add \$55 net per additional color beyond the case color. When ordering multiple cabinets that are identical in color pattern, the \$55 net per additional color is applied just once.

Example:

Case Color plus 1 additional color	\$55 net
Case Color plus 2 additional colors	\$110 net
Case Color plus 3 additional colors	\$165 net
Case Color plus 4 additional colors	\$220 net
Case Color plus 5 additional colors	\$275 net
Case Color plus 6 additional colors	\$330 net
Case Color plus 7 additional colors	\$385 net
Case Color plus 8 additional colors	\$440 net

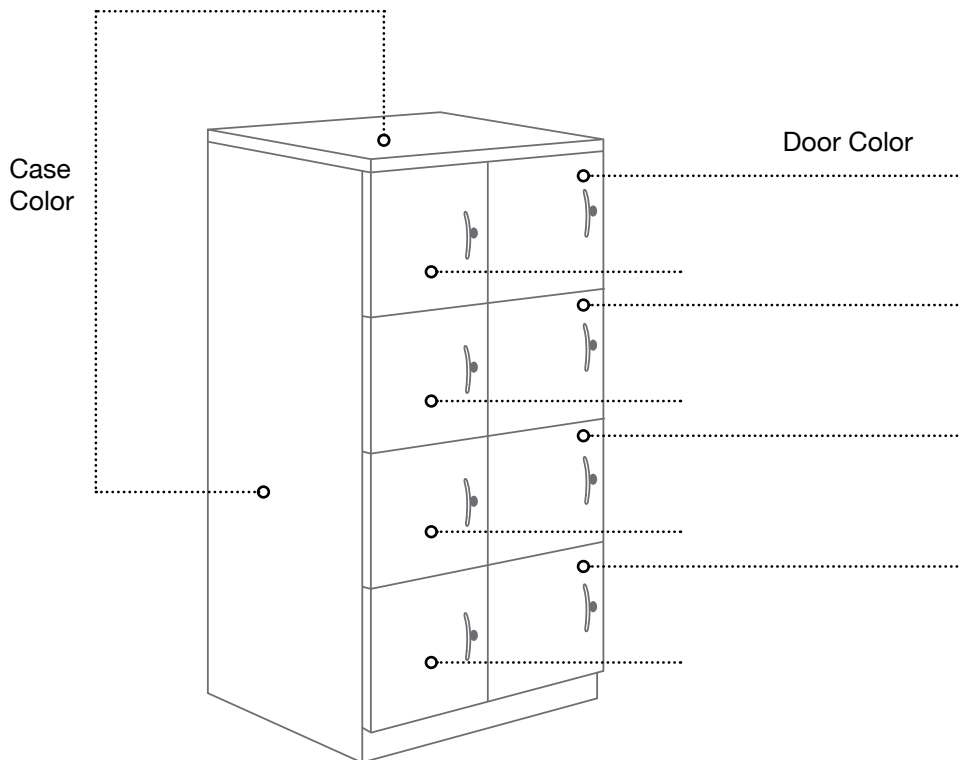



Basic Construction

- All Great Openings products meet or exceed applicable ANSI-BIFMA standards for durability and safety
- Welded steel frame construction and formed channels ensure strength in key areas
- Reinforced vertical and horizontal channels ensure dimensional stability
- Top, back, side and center panels are 21 gauge steel
- Inner top, bottom, and side channels are 18 gauge steel
- Drawer and door fronts are 20-22 gauge steel
- Shelves are 18 gauge steel, and drawer bins are 22 gauge
- Concealed hinges allow for 110° opening
- Shelves are ¾" tall and are adjustable in 1-1/2" increments
- Four leveling glides with 7/8" adjustment ensure proper alignment and operation, and are accessible from inside the cabinet
- Mobile Cupboard Wardrobe Tower includes 75mm casters, two locking and two non-locking
- Tower drawers include full-extension steel ball-bearing slides, with anti-rebound and quick disconnect features
- The front-facing kick plate on Trace towers is 3.25" high

Features

- Laminate fronts may be specified for 2-high and 3-high double door storage cabinets and cupboard wardrobe towers

Options and Accessories

- All options and accessories are sold separately or are available as an upgrade
- In towers, file drawer dividers allow for side-to-side filing
- Work Surface Support Bracket attaches to the Bookcase Wardrobe Tower or Bookcase Tower

Lock System

- Keyed locks include randomly-assigned UM Series locks
- UM locks are black-faced, master-keyed, and core-removable
- Locks may be keyed-alike in the field
- Other key series are available, including Haworth SL, bright nickel LL, and Knoll K. See the Specification Guide for details and how to order
- Towers include safety interlock that allows only one drawer to open at a time
- Towers are not available with individually locking doors/drawers

Can I customize?

- Towers with special heights, widths, depths, and drawer/cupboard configurations are one of our specialties! Call for details

Trace Towers and Storage File Inside Dimensions (in inches)

	Inner Height	Inner Width	Inner Depth
Coat Closets - All Towers			
Coat closet in 65-7/8" tower	61.070"	6.000"	22.750"
Coat closet in 56" tower	51.236"	6.000"	22.750"
Coat closet in 51-3/8" tower	46.575"	6.000"	22.750"
Coat closet in 46" tower	41.112"	6.000"	22.750"
Coat closet in 39-7/8" tower	35.000"	6.000"	22.750"
Cupboards - All Towers			
Tall Cupboard in 65-7/8" tower	37.250"	12.500"	22.750"
Short Cupboard in 65-7/8" tower	25.938"	12.500"	22.750"
Cupboard in 56" tower	27.650"	12.500"	22.750"
Tall Cupboard in 51-3/8" tower	22.800"	12.500"	22.750"
Short Cupboard in 51-3/8" tower	11.541"	12.500"	22.750"
Cupboard in 46" tower	17.291"	12.500"	22.750"
Cupboard in 39-7/8" tower	11.630"	12.500"	22.750"
Bookcases - All Towers			
Bookcase in 65-7/8" tower	36.000"	21.500"	15.000"
Bookcase in 56" tower	26.497"	21.500"	15.000"
Bookcase in 51-3/8" tower	21.500"	21.500"	15.000"
Bookcase in 46" tower	16.376"	21.500"	15.000"
Drawers and Shelves - All Towers			
Bookcase in 65-7/8" tower	5.1"	26.7"	15.000"
Box Drawer	4.500"	12.125"	18.810"
File Drawer	9.500"	12.125"	18.810"
Adjustable shelf thickness	1.000"		

TRACE TOWERS

SIN 33721

TRACE Cupboard Wardrobe Tower



- Single lock captures all doors and drawers
- Coat closet includes side-to-side coat rod
- 39-7/8" tower: no adjustable shelf
- 46" tower: no adjustable shelf
- 51-3/8" tower w/ 24.5" cupboard: one adjustable shelf
- 51-3/8" tower w/ 13" cupboard: no adjustable shelf
- 56" tower: one adjustable shelf
- 65-7/8" tower w/ 39" cupboard: two adjustable shelves
- 65-7/8" tower w/ 27" cupboard: one adjustable shelf

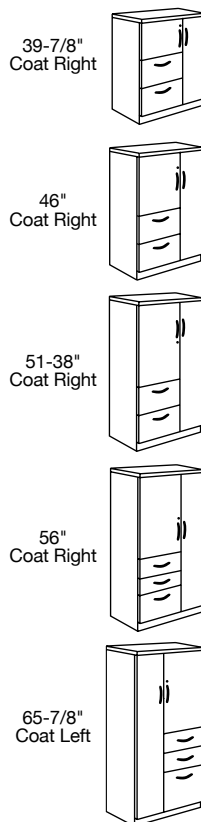

H	D	W	Coat Door	Drawer Options	Pkg Wt	Pkg Cube	Part #	Front	Part #	Metal Color	Price
39-7/8	23-1/2	23-1/2	left	2 file drawers, 13" cupboard	136 lb	18.0 ft	DG	?	A354	?	\$2,157
			left	2 box/1 file drawer, 13" cupboard	139 lb	18.0 ft	DG	?	A338	?	\$2,196
39-7/8	23-1/2	23-1/2	right	2 file drawers, 13" cupboard	136 lb	18.0 ft	WG	?	A354	?	\$2,157
			right	2 box/1 file drawer, 13" cupboard	139 lb	18.0 ft	WG	?	A338	?	\$2,196
46	23-1/2	23-1/2	left	2 file drawers, 19" cupboard	150 lb	19.5 ft	DG	?	4454	?	\$2,211
			left	2 box/1 file drawer, 19" cupboard	153 lb	19.5 ft	DG	?	4472	?	\$2,347
46	23-1/2	23-1/2	right	2 file drawers, 19" cupboard	150 lb	19.5 ft	WG	?	4454	?	\$2,211
			right	2 box/1 file drawer, 19" cupboard	153 lb	19.5 ft	WG	?	4472	?	\$2,347
51-3/8	23-1/2	23-1/2	left	2 file drawers, 24.5" cupboard	164 lb	21.0 ft	DG	?	J654	?	\$2,264
			left	2 box/1 file drawer, 24.5" cupboard	167 lb	21.0 ft	DG	?	J672	?	\$2,348
			left	3 file drawers, 13" cupboard	175 lb	21.0 ft	DG	?	J652	?	\$2,418
51-3/8	23-1/2	23-1/2	right	2 file drawers, 24.5" cupboard	164 lb	21.0 ft	WG	?	J654	?	\$2,264
			right	2 box/1 file drawer, 24.5" cupboard	167 lb	21.0 ft	WG	?	J672	?	\$2,348
			right	3 file drawers, 13" cupboard	175 lb	21.0 ft	WG	?	J652	?	\$2,418
56	23-1/2	23-1/2	left	2 file drawers, 29" cupboard	178 lb	23 ft	DG	?	A754	?	\$2,272
			left	2 box/1 file drawer, 29" cupboard	181 lb	23 ft	DG	?	A772	?	\$2,432
56	23-1/2	23-1/2	right	2 file drawers, 29" cupboard	178 lb	23 ft	WG	?	A754	?	\$2,272
			right	2 box/1 file drawer, 29" cupboard	181 lb	23 ft	WG	?	A772	?	\$2,432
65-7/8	23-1/2	23-1/2	left	2 file drawers, 39" cupboard	193 lb	25.7 ft	DG	?	C254	?	\$2,431
			left	2 box/1 file drawer, 39" cupboard	195 lb	25.7 ft	DG	?	C272	?	\$2,515
			left	3 file drawers, 27" cupboard	195 lb	25.7 ft	DG	?	C252	?	\$2,515
			left	2 box/2 file drawers, 27" cupboard	197 lb	25.7 ft	DG	?	C258	?	\$2,598
65-7/8	23-1/2	23-1/2	right	2 file drawers, 39" cupboard	193 lb	25.7 ft	WG	?	C254	?	\$2,431
			right	2 box/1 file drawer, 39" cupboard	195 lb	25.7 ft	WG	?	C272	?	\$2,515
			right	3 file drawers, 27" cupboard	195 lb	25.7 ft	WG	?	C252	?	\$2,515
			right	2 box/2 file drawers, 27" cupboard	197 lb	25.7 ft	WG	?	C258	?	\$2,598

Available Fronts | A D F N Q | S

TRACE TOWERS

SIN 33721

TRACE Mobile Cupboard Wardrobe Tower

- Black 75mm casters: (2) locking and (2) non-locking
- Height listed includes casters (approximately 3")
- 43-1/4" tower: no adjustable shelf
- 54-3/4" tower: one adjustable shelf



H	D	W	Coat Door	Drawer Options	Pkg Wt	Pkg Cube	Part #	Front	Part #	Metal Color	Price
43-1/4	23-1/2	23-1/2	left	file/file	136 lb	18 ft	DG	?	9954	?	\$2,359
			right	file/file	136 lb	18 ft	WG	?	9954	?	\$2,359
54-3/4	23-1/2	23-1/2	left	file/file	170 lb	21 ft	DG	?	J854	?	\$2,570
			right	file/file	170 lb	21 ft	WG	?	J854	?	\$2,570

43-1/4"
Coat Left



54-3/4"
Coat Left



Available Fronts | A B D | F H I N P Q | S

TRACE TOWERS

SIN 33721

TRACE Cupboard Tower



- Single lock captures cupboard and drawers
- 46" tower: no adjustable shelf
- 51-3/8" tower: one adjustable shelf
- 56" tower: one adjustable shelf
- 65-7/8" tower: two adjustable shelves
- Will not accommodate Work Surface Supporting Bracket

H	D	W	Hinge Location	Drawer Options	Pkg Wt	Pkg Cube	Part #	Front Style	Part #	Metal Color	Price
46	23 -1/2	15 -1/4	left	file/file 19.2" cupboard	81 lb	11 ft	CL	?	N309	?	\$1,352
			right	file/file 19.2" cupboard	81 lb	11 ft	CR	?	N309	?	\$1,352
46	23 -1/2	15 -1/4	left	box/box/file 19.2" cupboard	83 lb	11 ft	CL	?	N311	?	\$1,488
			right	box/box/file 19.2" cupboard	83 lb	11 ft	CR	?	N311	?	\$1,488
51-3/8	23 -1/2	15 -1/4	left	file/file 24.5" cupboard	85 lb	14.2 ft	CL	?	K409	?	\$1,383
			right	file/file 24.5" cupboard	85 lb	14.2 ft	CR	?	K409	?	\$1,383
51-3/8	23 -1/2	15 -1/4	left	box/box/file 24.5" cupboard	87 lb	14.2 ft	CL	?	K411	?	\$1,519
			right	box/box/file 24.5" cupboard	87 lb	14.2 ft	CR	?	K411	?	\$1,519
56	23 -1/2	15 -1/4	left	file/file 29" cupboard	88 lb	15.4 ft	CL	?	N209	?	\$1,416
			right	file/file 29" cupboard	88 lb	15.4 ft	CR	?	N209	?	\$1,416
56	23 -1/2	15 -1/4	left	box/box/file 29" cupboard	91 lb	15.8 ft	CL	?	N211	?	\$1,551
			right	box/box/file 29" cupboard	91 lb	15.8 ft	CR	?	N211	?	\$1,551
65 -7/8	23 -1/2	15 -1/4	left	file/file 39" cupboard	93 lb	17.3 ft	CL	?	K309	?	\$1,456
			right	file/file 39" cupboard	93 lb	17.3 ft	CR	?	K309	?	\$1,456
65 -7/8	23 -1/2	15 -1/4	left	box/box/file 39" cupboard	95 lb	17.3 ft	CL	?	K311	?	\$1,592
			right	box/box/file 39" cupboard	95 lb	17.3 ft	CR	?	K311	?	\$1,592

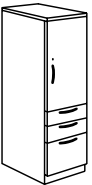

Available Fronts | A D | F N Q | S

TRACE TOWERS

SIN 33721

TRACE Bookcase Wardrobe Tower



- Tower includes two locks, keyed-alike
- Coat closet includes a two-pronged coat hook
- 46" tower: no adjustable shelf
- 51-3/8" tower: one adjustable shelf
- 56" tower: one adjustable shelf
- 65-7/8" tower: two adjustable shelves
- Work Surface Supporting Bracket may be added

H	D	W	Coat Door	Drawer Options	Pkg Wt	Pkg Cube	Part #	Front	Part #	Metal Color	Price
46	23-1/2	23-1/2	left	file/file	145 lb	18.4 ft	LG	?	V709	?	\$2,322
			left	box/box/file	148 lb	18.4 ft	LG	?	V711	?	\$2,406
46	23-1/2	23-1/2	right	file/file	145 lb	18.4 ft	MG	?	V709	?	\$2,322
			right	box/box/file	148 lb	18.4 ft	MG	?	V711	?	\$2,406
51-3/8	23-1/2	23-1/2	left	file/file	152 lb	21.0 ft	LG	?	J609	?	\$2,396
			left	box/box/file	155 lb	21.0 ft	LG	?	J611	?	\$2,480
51-3/8	23-1/2	23-1/2	right	file/file	152 lb	21.0 ft	MG	?	J609	?	\$2,396
			right	box/box/file	155 lb	21.0 ft	MG	?	J611	?	\$2,480
56	23-1/2	23-1/2	left	file/file	159 lb	23.4 ft	LG	?	V609	?	\$2,472
			left	box/box/file	162 lb	23.4 ft	LG	?	V611	?	\$2,554
56	23-1/2	23-1/2	right	file/file	159 lb	23.4 ft	MG	?	V609	?	\$2,472
			right	box/box/file	162 lb	23.4 ft	MG	?	V611	?	\$2,554
65-7/8	23-1/2	23-1/2	left	file/file	166 lb	25.7 ft	LG	?	C209	?	\$2,606
			left	box/box/file	169 lb	25.7 ft	LG	?	C211	?	\$2,689
65-7/8	23-1/2	23-1/2	right	file/file	166 lb	25.7 ft	MG	?	C209	?	\$2,606
			right	box/box/file	169 lb	25.7 ft	MG	?	C211	?	\$2,689

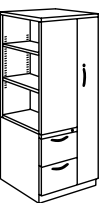
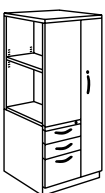
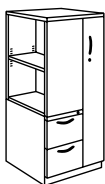
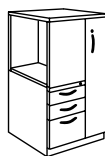

Available Fronts | A B D F H K N P Q | S

TRACE Bookcase Tower



- Single lock captures all drawers
- 46" tower: no adjustable shelf
- 51-3/8" tower: one adjustable shelf
- 56" tower: one adjustable shelf
- 65-7/8" tower: two adjustable shelves
- Work Surface Supporting Bracket may be added

H	D	W	Bookcase Facing	Drawer Options	Pkg Wt	Pkg Cube	Part #	Front	Part #	Metal Color	Price
46	23-1/2	15-1/4	left	file/file	82 lb	12.5 ft	BL	?	4609	?	\$1,308
			left	box/box/file	87 lb	12.5 ft	BL	?	4611	?	\$1,342
46	23-1/2	15-1/4	right	file/file	82 lb	12.5 ft	BR	?	4609	?	\$1,308
			right	box/box/file	87 lb	12.5 ft	BR	?	4611	?	\$1,342
51-3/8	23-1/2	15-1/4	left	file/file	85 lb	14.2 ft	BL	?	5109	?	\$1,316
			left	box/box/file	90 lb	14.2 ft	BL	?	5111	?	\$1,358
51-3/8	23-1/2	15-1/4	right	file/file	85 lb	14.2 ft	BR	?	5109	?	\$1,316
			right	box/box/file	90 lb	14.2 ft	BR	?	5111	?	\$1,358
56	23-1/2	15-1/4	left	file/file	87 lb	15.6 ft	BL	?	5609	?	\$1,327
			left	box/box/file	93 lb	15.6 ft	BL	?	5611	?	\$1,373
56	23-1/2	15-1/4	right	file/file	87 lb	15.6 ft	BR	?	5609	?	\$1,327
			right	box/box/file	93 lb	15.6 ft	BR	?	5611	?	\$1,373
65-7/8	23-1/2	15-1/4	left	file/file	90 lb	17.3 ft	BL	?	6509	?	\$1,344
			left	box/box/file	95 lb	17.3 ft	BL	?	6511	?	\$1,402
65-7/8	23-1/2	15-1/4	right	file/file	90 lb	17.3 ft	BR	?	6509	?	\$1,344
			right	box/box/file	95 lb	17.3 ft	BR	?	6511	?	\$1,402

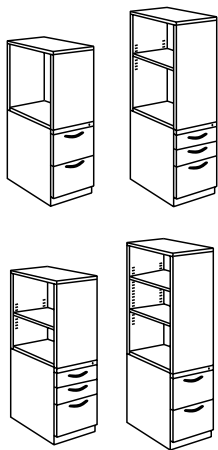

Available Fronts | A D | F N Q | S

Work Surface Supporting Bracket

- May be added to any Bookcase Wardrobe Tower or Bookcase Tower with side facing bookcase
- May not be used on cupboard tower
- Factory installed only
- Supports 1-1/4" work surface at 27-3/4" finish height
- Black bracket is 17" wide, extends 3"
- Three mounting holes for work surface attachment
- Modesty panel not available for this application

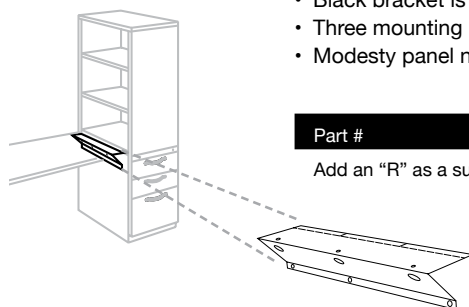

Part #	Price
Add an "R" as a suffix to the Bookcase Wardrobe Tower or Bookcase Tower part number.	\$70



Basic Construction

- All Great Openings products meet or exceed applicable ANSI-BIFMA standards for durability and safety
- Welded steel frame construction and formed channels ensure strength in key areas
- Reinforced vertical and horizontal channels ensure dimensional stability
- Double Door Storage Cabinet metal gauge: Top, back, side and center panels are 21 gauge steel, inner top, bottom, and side channels are 18 gauge steel. Door fronts are 20-22 gauge steel. Shelves are 18 gauge steel
- Concealed hinges allow for 110° opening
- Four leveling glides with 1-1/4" adjustment ensure proper alignment and operation, and are accessible from inside the cabinet
- Shelves are 3/4" thick and are adjustable in 1-1/2" increments
- Inside width dimensions shown in "Inside Dimensions" table are for the door opening. An additional 1.75" in width is available once inside the door hinges
- The front-facing kick plate on Trace double door storage cabinets is 3.25" high

Features

- Top is mechanically fastened, so may be replaced with laminate top

Options and Accessories

- All options and accessories are sold separately or are available as an upgrade
- Additional shelves are available for order
- Magnetic shelf divider, sold in packages of three

Lock System

- Keyed locks include randomly-assigned UM Series locks
- UM locks are black-faced, master-keyed, and core-removable
- Locks may be keyed-alike in the field
- Other key series are available, including Haworth SL, bright nickel LL, and Knoll K. See the Specification Guide for details and how to order
- Double Doors Storage Cabinets are not available with individually locking doors
- Electronic locks are available. Please call Sales for details

Trace Storage Cabinet Inside Dimensions (in inches)

	Inner Height	Inner Width	Inner Depth
(each shelf is .75" tall, so deduct .75" inside height per shelf)			
(gain 1.75" in width, once past the hinges)			
2-high cabinet, 30" wide	23.5"	26.75"	17.3"
2-high cabinet, 36" wide	23.5"	32.75"	17.3"
2-high cabinet, 42" wide	23.5"	38.75"	17.3"
3-high cabinet, 30" wide	35.0"	26.75"	17.3"
3-high cabinet, 36" wide	35.0"	32.75"	17.3"
3-high cabinet, 42" wide	35.0"	38.75"	17.3"
4-high cabinet, 30" wide	46.5"	26.75"	17.3"
4-high cabinet, 36" wide	46.5"	32.75"	17.3"
4-high cabinet, 42" wide	46.5"	38.75"	17.3"
5-high cabinet, 30" wide	61.0"	26.75"	17.3"
5-high cabinet, 36" wide	61.0"	32.75"	17.3"
5-high cabinet, 42" wide	61.0"	38.75"	17.3"
6-high cabinet, 30" wide	72.5"	26.75"	17.3"
6-high cabinet, 36" wide	72.5"	32.75"	17.3"
6-high cabinet, 42" wide	72.5"	38.75"	17.3"

TRACE STORAGE CABINETS

SIN 33721

TRACE Double Door Storage Cabinet

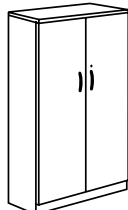
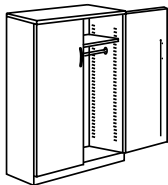
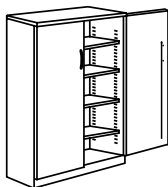
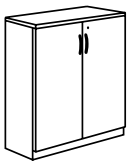
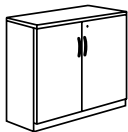
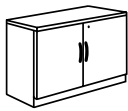

- See descriptions in table below for number of shelves included
- Common laminate tops are available
- Shelf load capacities:
 - 30" shelf - 140 lbs
 - 36" shelf - 140 lbs
 - 42" shelf - 140 lbs
- Note: each shelf is 3/4" tall
- Cabinet top weight capacities:
 - 30" cabinet - 140 bs
 - 36" cabinet - 168 lbs
 - 42" cabinet - 197 lbs

H	D	W	Description	Pkg Wt	Pkg Cube	Part #	Door Style	Part #	Metal Color	Price
28-3/8	18-1/4	30		66 lb	12.7 ft	CG	?	01F2	?	\$1,078
28-3/8	18-1/4	36	2-high double door 1 adjustable shelf	78 lb	15.5 ft	CG	?	02F3	?	\$1,174
28-3/8	18-1/4	42		90 lb	17.3 ft	CG	?	03F4	?	\$1,295
39-7/8	18-1/4	30		88 lb	17.4 ft	CG	?	04F2	?	\$1,314
39-7/8	18-1/4	36	3-high double door 2 adjustable shelves	100 lb	20.6 ft	CG	?	05F3	?	\$1,333
39-7/8	18-1/4	42		110 lb	23.7 ft	CG	?	06F4	?	\$1,421
51-3/8	18-1/4	30		113 lb	22.1 ft	CG	?	07F2	?	\$1,467
51-3/8	18-1/4	36	4-high double door 3 adjustable shelves	125 lb	26.1 ft	CG	?	08F3	?	\$1,596
51-3/8	18-1/4	42		137 lb	30.9 ft	CG	?	09F4	?	\$1,710
65-7/8	18-1/4	30		138 lb	28.0 ft	CG	?	10F2	?	\$1,768
65-7/8	18-1/4	36	5-high double door 4 adjustable shelves	150 lb	33.1 ft	CG	?	11F3	?	\$1,860
65-7/8	18-1/4	42		162 lb	38.1 ft	CG	?	12F4	?	\$2,007
65-7/8	18-1/4	36	5h x 36w w/coat rod no shelves	130 lb	33.0 ft	CG	?	11F5	?	\$1,698
65-7/8	18-1/4	36	5h x 36w w/shelf top/coat rod below	130 lb	33.0 ft	CG	?	11F6	?	\$1,768
77-3/8	18-1/4	30		168 lb	32.6 ft	CG	?	45F2	?	\$2,025
77-3/8	18-1/4	36	6-high double door	180 lb	38.6 ft	CG	?	46F3	?	\$2,117
77-3/8	18-1/4	42	5 adjustable shelves	192 lb	44.5 ft	CG	?	47F4	?	\$2,233
77-3/8	18-1/4	36	6h x 36w w/ shelf top/coat rod below	146 lb	38.6 ft	CG	?	46F7	?	\$2,025
			additional 30" shelf	8 lb	1.5 ft			DBS30	?	\$97
			additional 36" shelf	10 lb	1.5 ft			DBS36	?	\$97
			additional 42" shelf	12 lb	1.5 ft			DBS42	?	\$97

Available Fronts | A Q | S

Individual Tops for TRACE Double Door Storage Cabinets

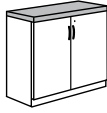

- Laminate top may be factory-installed or shipped separately
- When factory-installed, the list price shown will be added to the accompanying cabinet price
- A metal top is not included when using a laminate top
- The finish height of a storage cabinet file will be 5/8" taller when using a 1-1/4" laminate top than the height of a storage cabinet with metal top
- Specify any standard GO laminate and edge. Special order laminates may require an up-charge and/or extended lead-time; call for details
- Laminate tops used on individual storage cabinets are sized to be flush with the sides of the cabinet case, so that individual cabinets installed side-by-side will have no gaps between

Description	H	W	D	Pkg Wt	Pkg Cube	Part #	Lam/Edge #	Price
factory installed	1.25	30	18.25	n/a	n/a	Add laminate color as a suffix to the lateral part number	?	\$369
	1.25	36	18.25	n/a	n/a	Add this price to lateral price	?	\$413
	1.25	42	18.25	n/a	n/a		?	\$458
top shipped separately	1.25	30	18.25	19 lb	.6 ft	FC 1931	?	\$443
	1.25	36	18.25	23 lb	.7 ft	FC 1937	?	\$495
	1.25	42	18.25	26 lb	1.0 ft	FC 1943	?	\$549

Common Laminate Tops for TRACE Double Door Storage Cabinets

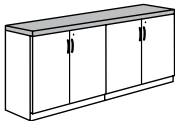

- Common laminate tops are shipped separately, to be installed in the field
- The finish height of a Trace Double Door Cabinet will be 5/8" taller when using a 1-1/4" laminate top than the height of a cabinet with metal top
- Common top sizes allow for 1/8" overhang on all four sides
- It is recommended that you remove the metal top from cabinet before attaching the common laminate top
- Specify any standard GO laminate and edge. Special order laminates may require an up-charge and/or extended lead-time; call for details

Two Cabinets Side-by-Side:	H	W	D	Pkg Wt	Pkg Cube	Part #	Lam/Edge #	Price
(2) 30" DD Storage Cabinet	1.25	60.25	18.50	39 lb	.8 ft	TL 1860	?	\$501
(1) 30" & (1) 36" DD Storage Cabinet	1.25	66.25	18.50	43 lb	.9 ft	TL 1866	?	\$546
(2) 36" DD Storage Cabinet	1.25	72.25	18.50	47 lb	1.0 ft	TL 1872	?	\$590
(2) 42" DD Storage Cabinet	1.25	84.25	18.50	55 lb	1.1 ft	TL 1884	?	\$645

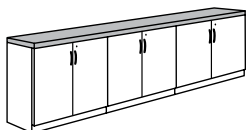

Three Cabinets Side-by-Side:	H	W	D	Pkg Wt	Pkg Cube	Part #	Lam/Edge #	Price
(3) 30" DD Storage Cabinet	1.25	90.25	18.50	58 lb	1.2 ft	TL 1890	?	\$651
(3) 36" DD Storage Cabinet	1.25	108.25	18.50	70 lb	1.4 ft	TL 18108	?	\$842
(3) 42" DD Storage Cabinet	1.25	126.25	18.50	82 lb	1.7 ft	TL 18126	?	\$1,056

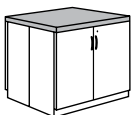

Two Cabinets Back-to-Back:	H	W	D	Pkg Wt	Pkg Cube	Part #	Lam/Edge #	Price
(2) 30" DD Storage Cabinet	1.25	30.25	36.75	39 lb	.8 ft	TL 3730	?	\$525
(2) 36" DD Storage Cabinet	1.25	36.25	36.75	47 lb	1.0 ft	TL 3736	?	\$636
(2) 42" DD Storage Cabinet	1.25	42.25	36.75	54 lb	1.1 ft	TL 3742	?	\$641

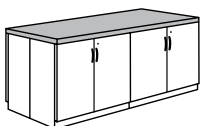

Four Cabinets Back-to-Back:	H	W	D	Pkg Wt	Pkg Cube	Part #	Lam/Edge #	Price
(4) 30" DD Storage Cabinet	1.25	60.25	36.75	77 lb	1.6 ft	TL 3760	?	\$845
(4) 36" DD Storage Cabinet	1.25	72.25	36.75	93 lb	1.9 ft	TL 3772	?	\$1,043
(4) 42" DD Storage Cabinet	1.25	84.25	36.75	108 lb	2.2 ft	TL 3784	?	\$1,099

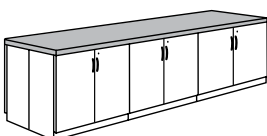

Six Cabinets Back-to-Back:	H	W	D	Pkg Wt	Pkg Cube	Part #	Lam/Edge #	Price
(6) 30" DD Storage Cabinet	1.25	90.25	36.75	116 lb	2.5 ft	TL 3790	?	\$1,225
(6) 36" DD Storage Cabinet	1.25	108.25	36.75	138 lb	2.8 ft	TL 37108	?	\$1,470
(6) 42" DD Storage Cabinet	1.25	126.25	36.75	162 lb	3.5 ft	TL 37126	?	\$1,737

TRACE Full Depth Double Door Cabinet

- Features are identical to the Trace Double Door Storage Cabinet
- Includes one side-to-side coat rod and single shelf above, or (4) or (5) adjustable shelves



H	D	W	Description	Pkg Wt	Pkg Cube	Part #	Door	Part #	Metal Color	Price
65-7/8	23-1/2	36	5h double door w/ shelf & coat rod	135 lb	38 ft	CG	?	U777	?	\$2,055
65-7/8	23-1/2	36	5h double door 4 adjustable shelves	165 lb	38 ft	CG	?	U7F3	?	\$2,162
77-3/8	23-1/2	36	6h double door w/ shelf & coat rod	155 lb	43 ft	CG	?	V877	?	\$2,256
77-3/8	23-1/2	36	6h double door 5 adjustable shelves	195 lb	43 ft	CG	?	V8F3	?	\$2,374
one additional shelf and clips								COL 036	?	\$103

Available Fronts | A  Q | S



Basic Construction

- All Great Openings products meet or exceed applicable ANSI-BIFMA standards for durability and safety
- Welded steel frame construction and formed channels ensure strength in key areas
- Double wall construction on side panels
- Bottom channels, top and shelves are all 18 gauge
- Back panel, side channels and side panels are 22 gauge.
- Shelves are 1" tall and are adjustable in 1/2" increments
- Four leveling glides with 5/8" adjustment ensure proper alignment and operation
- Actual outside widths of bookcases are:
 - 30" = 29-11/16"
 - 36" = 35-11/16"
 - 42" = 41-11/16"
- Outer side panels are flush with the sides of bookcase top, so there's no gap between bookcases when installed side-by-side
- To ensure stability, 4, 5, and 6-high bookcases should be installed against a wall or other solid object
- Shelf capacity, all widths: 140 lbs

Features

- 2-high bookcases will accommodate binder-height storage on both shelves. For all other bookcases, binder-height storage is available on all but one shelf
- Top is mechanically fastened, so may be replaced with a laminate top

Options and Accessories

- All options and accessories are sold separately or are available as an upgrade
- Additional shelves are available for order
- Magnetic shelf divider, sold in packages of three

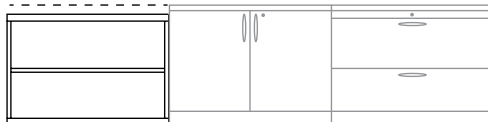

Note that the 2-high bookcase is slightly shorter than the 2-high lateral file and double door storage cabinet. The bookcase is designed to fit under a work surface.

Trace Bookcase Inside Dimensions (in inches)

	Inner Height	Inner Width	Inner Depth
(Each shelf is 1" thick, so deduct 1" inside height per shelf)			
2-high bookcase, 30" wide	25.19"	27.69"	13.06"
2-high bookcase, 36" wide	25.19"	33.69"	13.06"
2-high bookcase, 42" wide	25.19"	39.42"	13.06"
3-high bookcase, 30" wide	37.31"	27.69"	13.06"
3-high bookcase, 36" wide	37.31"	33.69"	13.06"
3-high bookcase, 42" wide	37.31"	39.42"	13.06"
4-high bookcase, 30" wide	48.81"	27.69"	13.06"
4-high bookcase, 36" wide	48.81"	33.69"	13.06"
4-high bookcase, 42" wide	48.81"	39.42"	13.06"
5-high bookcase, 30" wide	63.31"	27.69"	13.06"
5-high bookcase, 36" wide	63.31"	33.69"	13.06"
5-high bookcase, 42" wide	63.31"	39.42"	13.06"
6-high bookcase, 30" wide	74.81"	27.69"	13.06"
6-high bookcase, 36" wide	74.81"	33.69"	13.06"
6-high bookcase, 42" wide	74.81"	39.42"	13.06"

TRACE Bookcase



H	D	W	Shelf Options	Pkg Wt	Pkg Cube	Part #	Metal Color	Price
27-3/4	13-7/16	30	2-high bookcase 1 adjustable shelf	55 lb	10.0 ft	GBS 3028	?	\$740
27-3/4	13-7/16	36		67 lb	11.3 ft	GBS 3628	?	\$776
27-3/4	13-7/16	42		79 lb	13.0 ft	GBS 4228	?	\$815
39-7/8	13-7/16	30	3-high bookcase 2 adjustable shelves	70 lb	13.6 ft	GBS 3040	?	\$845
39-7/8	13-7/16	36		82 lb	16.1 ft	GBS 3640	?	\$864
39-7/8	13-7/16	42		94 lb	18.6 ft	GBS 4240	?	\$900
51-3/8	13-7/16	30	4-high bookcase 3 adjustable shelves	85 lb	14.2 ft	GBS 3052	?	\$926
51-3/8	13-7/16	36		90 lb	17.2 ft	GBS 3652	?	\$962
51-3/8	13-7/16	42		114 lb	23.7 ft	GBS 4252	?	\$1,000
65-7/8	13-7/16	30	5-high bookcase 4 adjustable shelves	106 lb	21.3 ft	GBS 3066	?	\$1,024
65-7/8	13-7/16	36		118 lb	25.3 ft	GBS 3666	?	\$1,068
65-7/8	13-7/16	42		130 lb	29.2 ft	GBS 4266	?	\$1,104
77-3/8	13-7/16	30	6-high bookcase 5 adjustable shelves	122 lb	25.4 ft	GBS 3077	?	\$1,111
77-3/8	13-7/16	36		134 lb	30.1 ft	GBS 3677	?	\$1,147
77-3/8	13-7/16	42		146 lb	34.7 ft	GBS 4277	?	\$1,191
			additional 30" shelf	6 lb	1.5 ft	BK 0700S	?	\$87
additional shelves			additional 36" shelf	7 lb	1.5 ft	BK 0800S	?	\$87
			additional 42" shelf	8 lb	1.5 ft	BK 0900S	?	\$87

**TRACE Bookcase
Laminate Top**

- Factory installed 1-1/4" laminate top replaces the standard metal top
- Finish height of bookcase will be 5/8" taller than the height of a standard bookcase with metal top
- Laminate top will overhang the metal bookcase sides by 1/8", and it will be flush at front and back
- Specify the laminate and edge band as a suffix to the bookcase part number
- Add the price shown to the list price of the bookcase

W	D	Description	Pkg Wt	Pkg Cube	Part #	Lam/Edge #	Price
29.94	13.4375	factory installed	15 lb	.28 ft	Add laminate color as a suffix to the bookcase part number	?	\$348
35.94	13.4375	factory installed	17 lb	.30 ft		?	\$370
41.94	13.4375	factory installed	19 lb	.40 ft		?	\$418

Mobile Bookcase



- Black 37mm plastic casters
- Casters: 2 locking, 2 non-locking
- Satin nickel loop pull on each side
- Bookcase itself is 30" wide
- With loop pulls, total width is 32-1/2"
- Inside clear height: 24" with 1/2" shelf
- Inside clear depth: 15", width: 27-7/8"
- Shelf is adjustable in 1/2" increments
- As with all GO bookcases, the mobile bookcase does include a back panel

H	D	W	Description	Pkg Wt	Pkg Cube	Part #	Metal Color	Price
26-1/2	15-1/4	32-1/2	1 adjustable shelf	57 lb	10.5 ft	MBC 2000	?	\$922

**Magnetic Shelf
Divider**

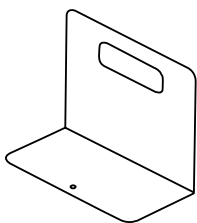

- Black magnetic dividers are 7.5" tall and 8" wide, with a 4" base. Magnet is 7-7/8" x 3"
- Appropriate for use on any lateral file drawer or shelf, bookcase, double door storage cabinet or overhead storage cabinet

H	D	W	Description	Pkg Wt	Pkg Cube	Part #	Price
7-1/2	4	8	(package of 3)	2 lb	2 ft	LFM 300 30	\$54

Basic Construction

- Cayenne storage cabinets feature 3" high architectural legs, available in two styles
- The Cayenne cabinet and drawer front heights do not match those of Trace storage
- All Great Openings products meet or exceed applicable ANSI-BIFMA standards for durability and safety
- Welded steel frame construction and formed channels ensure strength in key areas
- Reinforced vertical and horizontal channels ensure dimensional stability
- Top and side channels are 20 gauge cold rolled steel. Fronts, tops, outer panels are 20 and 22 gauge. Drawer bins and shelves are 18 and 20 gauge
- Metal and laminate tops are 5/8" thick
- Four leveling glides with 1/2" adjustment ensure proper alignment and operation

Features

- Cayenne cabinet and desk legs are painted 02R1 Nickel; any Great Openings cabinet or desk products may be painted that same color with no extra charge
- All drawers and roll-out shelves include full extension steel ball-bearing slides with anti-rebound features to ensure smooth operation
- Cayenne storage metal and laminate tops are sized to be flush with the sides of the cabinet, so that files installed side-to-side will have no gaps between
- Drawers include full-height side panels
- Two file bars are included in each drawer, for side-to-side filing. File conversion bars for front-to-back filing are sold separately
- Drawer bins will accommodate A4, Letter, and Legal size filing

Options and Accessories

- Cayenne storage may be ordered with metal top, laminate top, or no top. The no top option should be used when ganging two cabinets side-by-side with a common laminate top
- Cushions with non-slip backing are available in five sizes
- All options and accessories are sold separately or are available as an upgrade
- Laminate drawer fronts may be specified. See the Specification Guide for details
- Common laminate tops
- Individually locking drawers, either keyed or electronic
- File conversion bars for front-to-back filing
- Magnetic drawer dividers for Cayenne box drawers

Lock System

- All Great Openings products include randomly-assigned UM Series locks
- UM locks are black-faced, master-keyed, and core-removable
- Locks may be keyed-alike in the field
- Other key series are available, including Haworth SL, bright nickel LL, and Knoll K. See the Specification Guide for details and how to order
- The Cayenne lock system captures just the right hand side of drawer fronts
- Cayenne storage may not be ordered to include individually locking security drawers

Counterweights & Interlock

- The safety interlock mechanism is integrated into the drawer slides, allowing only one drawer to open at a time
- Counterweight is included as standard in Two Drawer cabinets and Rollout Shelf cabinets

Drawer Load Capacity

- Drawers and rollout shelf load capacity:
- 30", 36", and 42" wide drawers: 125 lb
- Fixed and adjustable shelf load capacity:
- 30" drawers: 95 lbs
 - 36" drawers: 116 lbs
 - 42" drawers: 136 lbs
- Cayenne storage metal top load capacity:
- 30" drawers: 140 lbs
 - 36" drawers: 168 lbs
 - 42" drawers: 192 lbs



S: Round



R: Rectangle

Storage Inside Dimensions (in inches)

	Inner Height	Inner Width	Inner Depth
File Drawers (the bin sides themselves are 9.18" high)			
30" wide	10.86"	26.7"	16.00"
36" wide	10.86"	32.7"	16.00"
42" wide	10.86"	38.7"	16.00"
Box Drawers (the bin sides themselves are 4.24" high)			
30" wide	4.54"	26.7"	16.00"
36" wide	4.54"	32.7"	16.00"
42" wide	4.54"	38.7"	16.00"
Open Shelf (height does not include .75" adjustable shelf)			
30" wide	16.39"	28.55	19.0"
36" wide	16.39"	34.55	19.0"
42" wide	16.39"	40.55	19.0"
Rollout Shelf (height does not include .75" adjustable shelf)			
30" wide	16.04"	26.73"	15.5"
36" wide	16.04"	32.73"	15.5"
42" wide	16.04"	38.73"	15.5"
Stack-on Cube (height does not include .75" adjustable shelf)			
One size	16.48"	15.50"	19.10"
Cayenne Lockers, 12" wide (height does not include .75" shelves)			
12" wide with coat rod	33.18"	9.87"	19.16"
12" wide with shelves	35.63"	9.87"	19.16"
Cayenne Lockers, 18" wide (height does not include .75" shelves)			
Coat closet section	33.18"	4.60"	19.16"
Shelf section (minus shelves)	35.63"	10.57"	16.16"

CAYENNE

SIN 33721

Cayenne Typical 1 Customized Credenza

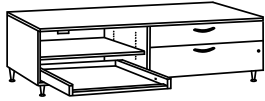

Overall Footprint: 20" deep x 72" wide

Our most common credenzas may be ordered using a single part number. See "Credenzas" in the "storage and accessories" section.

Included Elements	Part #	Price
(1) 20" x 72" common top for Cayenne low storage, no grommets	CYN 2072 ?	\$556
(1) 36"w x 20"d low storage, rollout shelf, round legs, no-top	M-LRT R4M5 S ? NT	\$1,134
(1) 36"w x 20"d low storage, two drawer, round legs, no-top	M-LRU ? R4L7 S ? NT	\$1,174
(1) credenza center leg support	CYPX 0050	\$75
Total List Price:		\$2,939

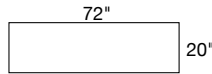

Cayenne Typical 2

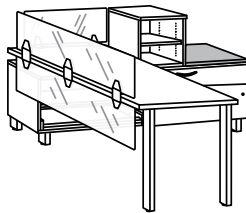

Overall Footprint: 72" deep x 66" wide

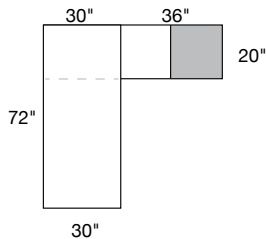

Included Elements	Part #	Price
(1) 20" x 66" common top for Cayenne low storage, no grommets	CYN 2066 ?	\$483
(1) 30"w x 20"d low storage, rollout shelf, rectangular legs, no-top	M-LRT R3M5 R ? NT	\$1,065
(1) 36"w x 20"d low storage, two drawer, rectangular legs, no-top	M-LRU ? R4L7 R ? NT	\$1,174
(1) 18"w x 20"d stack-on cube, laminate top	M-LROS Z5P9 LT ? ?	\$939
(1) credenza center leg support	CYPX 0050	\$75
(1) 18"w x 20"d cushion for Cayenne low storage	NSLP 2018 ?	\$221
(1) 30"w x 72" work surface top, no grommets	WS 3072 ?	\$709
(1) desk legs, rectangular, pkg of 2	TDR 02	\$305
(1) floating top support legs, one set	FLTS	\$115
(1) acrylic privacy screen, 60"w	ACR1160 F	\$538
(1) acrylic modesty panel, 60"w	ACR1160	\$531
(1) acrylic privacy screen, 30"w	ACR1130 F	\$260
Total List Price:		\$6,415

Cayenne Typical 3

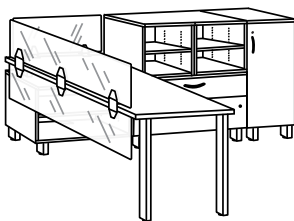

Overall Footprint: 72" deep x 78" wide

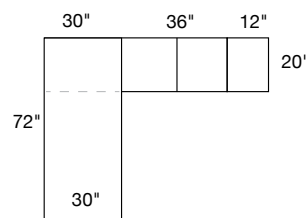

Included Elements	Part #	Price
(1) credenza: (1) 36" two drw & (1) 30" open shelf, rect. legs, lam. top	LRU ? Z307 R ? ?	\$2,524
(2) 18"w x 20"d stack-on cube, no top	M-LROS Z5P9 ? NT	\$1,392
(1) 12"w x 41 1/2"h tower, two shelves, hinge right, laminate top	RCU ? U5L9 R ? ?	\$1,947
(1) 36"w x 20"d common laminate top for two stack-on cabinets	CYN 2036 ?	\$386
(1) 30"d x 72"w work surface top, no grommets	WS 3072 ?	\$709
(1) desk legs, rectangular, pkg 2	TDR 02	\$305
(1) floating top support legs, one pair	FLTS	\$115
(1) acrylic privacy screen, 60"w	ACR 1160 F	\$538
(1) acrylic modesty panel, 60"w	ACR 1160	\$531
(1) acrylic privacy screen, 30"w	ACR 1130 F	\$260
Total List Price:		\$8,707

Cayenne Typical 4

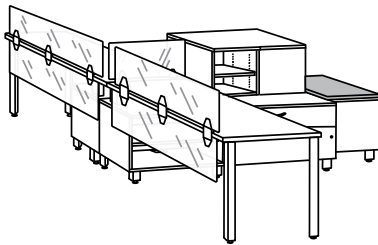

Overall Footprint: 144" deep x 86" wide

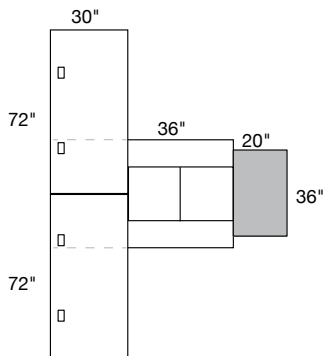

Included Elements	Part #	Price
(2) 30" x 72" work surface top, with grommets and stiffener	WS 3072 ? ST LR	\$1,656
(1) desk legs, rectangular, pkg 4	TDR04	\$609
(2) floating top support, one pair	FLTS	\$230
(2) 30" low storage, open shelf cabinet, rectangular legs, no top	M-LRO S R3L8 R ? NT	\$1,774
(2) 36" low storage, two drawer, rectangular legs, no top	M-LRU ? R4L7 R ? NT	\$2,348
(2) 66" common laminate top (for side-by-side low storage cabinets)	CYN 2066 ?	\$483
(2) 18"w x 20"d stack-on cube, no top	M-LRO S Z5P9 ? NT	\$1,392
(1) 36" common laminate top (for side-by-side stack-on cabinets)	CYN 2036 ?	\$386
(1) 36" low storage, rollout shelf, rectangular legs, no grommet, laminate top	M-LRT R4M5 R ? ? N	\$1,548
(1) 36" cushion	NSLP 2036 ?	\$370
(2) acrylic privacy screen, 60"w	ACR 1160 F	\$538
(2) acrylic modesty panel, 60"w	ACR 1160	\$531
(1) acrylic privacy screen, 30"w	ACR 1130 F	\$260
Total List Price:		\$12,125

Cayenne Typical 5

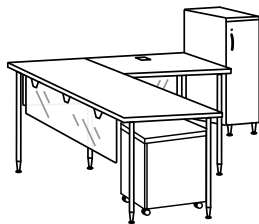

Overall Footprint: 72" deep x 90" wide

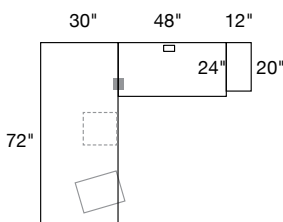

Included Elements	Part #	Price
(1) 30" x 72" work surface top, no grommets	WS 3072 ?	\$709
(1) 24" x 48" work surface, with grommet	WS 2448 ? G	\$508
(1) desk legs, round, pkg 4	TDS04	\$609
(1) desk legs, round, pkg 2	TDS02	\$305
(1) splice plate, pkg of 2	GSP 02K	\$46
(1) personal drawer	NFC 7657 889	\$227
(1) 12"w x 41 1/2"h tower, two shelves, hinge right, metal top	RCU ? U5L9 ?	\$1,596
(1) cushion mobile pedestal, black casters, box/file, 18 7/8" dp	U ? 1403 ? ? N	\$758
(1) acrylic modesty panel, 60"	ACR 1160	\$531
(1) acrylic modesty panel, 66"	ACR 1166	\$535
Total List Price:		\$5,824

CAYENNE

SIN 33721

Low Storage, Two Drawer



- Includes one box drawer and one file drawer, both with full extension slides
- Includes safety interlock, allowing just one drawer to open at a time
- Choose from two leg options, all 3" high
- Includes counterweight
- When ganging two cabinets together, order no-top units and a common laminate top with ganging kit

H	D	W	Top	Pkg Wt	Pkg Cube	Part #	Front	Part #	Leg Style	Metal Color	Lam/Edge #	Price
22-1/4	20	30	metal	125 lb	8.3 ft	M-LRU	?	R3L7	?	?	n/a	\$1,154
22-1/4	20	36	metal	145 lb	9.8 ft	M-LRU	?	R4L7	?	?	n/a	\$1,228
22-1/4	20	42	metal	165 lb	11.3 ft	M-LRU	?	U8L7	?	?	n/a	\$1,350
22-1/4	20	30	lam.	126 lb	8.3 ft	M-LRU	?	R3L7	?	?	?	\$1,494
22-1/4	20	36	lam.	146 lb	9.8 ft	M-LRU	?	R4L7	?	?	?	\$1,589
22-1/4	20	42	lam.	166 lb	11.3 ft	M-LRU	?	U8L7	?	?	?	\$1,749
21-5/8	20	30	none	118 lb	8.3 ft	M-LRU	?	R3L7	?	?	NT	\$1,104
21-5/8	20	36	none	137 lb	9.8 ft	M-LRU	?	R4L7	?	?	NT	\$1,174
21-5/8	20	42	none	155 lb	11.3 ft	M-LRU	?	U8L7	?	?	NT	\$1,291

Available Fronts | A B D F H K M R Q | S

Available Legs S: Round, R: Rectangle

Mobile Low Storage, Two Drawer



- Metal or laminate top
- Includes one box drawer and one file drawer, both with full extension slides
- Includes safety interlock, allowing just one drawer to open at a time
- Includes counterweight
- Includes black 75mm casters, two locking and two non-locking

H	D	W	Top	Pkg Wt	Pkg Cube	Part #	Front	Part #	Leg Style	Metal Color	Lam/Edge #	Price
22-7/8	20	30	metal	125 lb	8.3 ft	M-LRU	?	R3L7	M	?	n/a	\$1,154
22-7/8	20	36	metal	145 lb	8.3 ft	M-LRU	?	R4L7	M	?	n/a	\$1,228
22-7/8	20	42	metal	165 lb	8.3 ft	M-LRU	?	U8L7	M	?	n/a	\$1,350
22-7/8	20	30	lam.	126 lb	8.3 ft	M-LRU	?	R3L7	M	?	?	\$1,494
22-7/8	20	36	lam.	146 lb	8.3 ft	M-LRU	?	R4L7	M	?	?	\$1,589
22-7/8	20	42	lam.	166 lb	8.3 ft	M-LRU	?	U8L7	M	?	?	\$1,749

Available Fronts | A B D F H K M R Q | S

Low Storage, Open Shelves

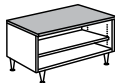

- Includes one adjustable shelf
- This unit does not include a false back
- Choose from two leg options, all 3" high
- No counterweight is needed
- When ganging two cabinets together, order no-top units and also a common laminate top with ganging kit

H	D	W	Top	Pkg Wt	Pkg Cube	Part #	Leg Style	Metal Color	Lam/Edge #	Price
22-1/4	20	18	metal	49 lb	5.4 ft	M-LROS Z5P5	?	?	n/a	\$897
22-1/4	20	30	metal	63 lb	8.3 ft	M-LROS R3L8	?	?	n/a	\$937
22-1/4	20	36	metal	70 lb	9.8 ft	M-LROS R4L8	?	?	n/a	\$997
22-1/4	20	42	metal	77 lb	11.3 ft	M-LROS U8L8	?	?	n/a	\$1,097
22-1/4	20	18	lam.	51 lb	5.4 ft	M-LROS Z5P5	?	?	?	\$1,222
22-1/4	20	30	lam.	64 lb	8.3 ft	M-LROS R3L8	?	?	?	\$1,276
22-1/4	20	36	lam.	71 lb	9.8 ft	M-LROS R4L8	?	?	?	\$1,358
22-1/4	20	42	lam.	78 lb	11.3 ft	M-LROS U8L8	?	?	?	\$1,497
21-5/8	20	18	none	46 lb	5.4 ft	M-LROS Z5P5	?	?	NT	\$849
21-5/8	20	30	none	57 lb	8.3 ft	M-LROS R3L8	?	?	NT	\$887
21-5/8	20	36	none	63 lb	9.8 ft	M-LROS R4L8	?	?	NT	\$943
21-5/8	20	42	none	68 lb	11.3 ft	M-LROS U8L8	?	?	NT	\$1,038

Available Legs S: Round, R: Rectangle

Low Storage, Rollout Shelf



- Includes one adjustable shelf
- Binder height storage is available on the bottom rollout shelf
- The full length of wires are visible from top and bottom of cabinet and via three inside grommets
- Choose from two leg options, all 3" high
- Includes counterweight
- When ganging two cabinets together, order no-top units and also a common laminate top with ganging kit

H	D	W	Top	Pkg Wt	Pkg Cube	Part #	Leg Style	Metal Color	Lam/Edge #	Price
22-1/4	20	30	metal	116 lb	8.3 ft	M-LRT R3M5	?	?	n/a	\$1,117
22-1/4	20	36	metal	123 lb	9.8 ft	M-LRT R4M5	?	?	n/a	\$1,188
22-1/4	20	42	metal	130 lb	11.3 ft	M-LRT U8M5	?	?	n/a	\$1,305
22-1/4	20	30	lam.	117 lb	8.3 ft	M-LRT R3M5	?	?	?	\$1,456
22-1/4	20	36	lam.	124 lb	9.8 ft	M-LRT R4M5	?	?	?	\$1,548
22-1/4	20	42	lam.	131 lb	11.3 ft	M-LRT U8M5	?	?	?	\$1,703
21-5/8	20	30	none	109 lb	8.3 ft	M-LRT R3M5	?	?	NT	\$1,065
21-5/8	20	36	none	115 lb	9.8 ft	M-LRT R4M5	?	?	NT	\$1,134
21-5/8	20	42	none	120 lb	11.3 ft	M-LRT U8M5	?	?	NT	\$1,247

Available Legs S: Round, R: Rectangle

Stack-on Cube

- Provides flexible storage as well as seated-height privacy and sit-to-stand work surface heights
- When sitting on top of low storage cabinet, finish height is 41-1/2" high
- Cabinet rests on four rubber pads to prevent slipping



H	D	W	Top	Pkg Wt	Pkg Cube	Part #	Metal Color	Lam/Edge #	Price
19-3/8	20	18	metal	62 lb	8.0 ft	M-LROS Z5P9	?	n/a	\$745
19-3/8	20	18	laminate	63 lb	8.0 ft	M-LROS Z5P9 LT	?	?	\$939
18-3/4	20	18	none	61 lb	8.0 ft	M-LROS Z5P9	?	nt	\$696

Credenza

- Selected storage cabinets are pre-configured into credenzas so you may order them using a single part number
- Each credenza includes:
 - 2 low storage cabinets
 - 1 common laminate top with ganging kit
 - 1 credenza center leg support (total of 5 legs)
- Credenzas must be assembled in the field
- Cabinets are unhandled so may be configured on left or right side or facing opposite directions



H	D	W	Top	Pkg Wt	Pkg Cube	Part #	Front	Part #	Leg Style	Metal Color	Lam/Edge #	Price
22-1/4	20	48	(1) 30" two drawer & (1) 18" open shelf	175 lb	13.6 ft	LRU	?	Z1N9	?	?	?	\$2,346
22-1/4	20	54	(1) 36" two drawer & (1) 18" open shelf	190 lb	15.1 ft	LRU	?	Z201	?	?	?	\$2,421
22-1/4	20	60	(1) 30" two drawer & (1) 30" open shelf	195 lb	16.6 ft	LRU	?	S705	?	?	?	\$2,449
22-1/4	20	60	(1) 42" two drawer & (1) 18" open shelf	215 lb	16.6 ft	LRU	?	S702	?	?	?	\$2,598
22-1/4	20	66	(1) 36" two drawer & (1) 30" two drawer	272 lb	18.1 ft	LRU	?	Z303	?	?	?	\$2,742
22-1/4	20	66	(1) 30" two drawer & (1) 36" open shelf	197 lb	18.1 ft	LRU	?	Z306	?	?	?	\$2,511
22-1/4	20	66	(1) 36" two drawer & (1) 30" open shelf	210 lb	18.1 ft	LRU	?	Z307	?	?	?	\$2,524
22-1/4	20	72	(1) 36" two drawer & (1) 36" two drawer	292 lb	19.6 ft	LRU	?	S808	?	?	?	\$2,887
22-1/4	20	72	(1) 36" two drawer & (1) 36" open shelf	217 lb	19.6 ft	LRU	?	S809	?	?	?	\$2,655
22-1/4	20	72	(1) 42" two drawer & (1) 30" two drawer	292 lb	19.6 ft	LRU	?	S8P1	?	?	?	\$2,933
22-1/4	20	72	(1) 30" two drawer & (1) 42" open shelf	204 lb	19.6 ft	LRU	?	S8P2	?	?	?	\$2,679
22-1/4	20	72	(1) 42" two drawer & (1) 30" open shelf	230 lb	19.6 ft	LRU	?	S8P3	?	?	?	\$2,716

Available Legs

S: Round, R: Rectangle

Available Fronts



Common Tops with Ganging Kit

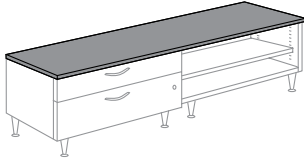

- Create your own credenza by ordering any two Cayenne Low Storage cabinets with the appropriate common top
- Laminate top is 5/8" thick and includes pre-drilled holes for easy assembly
- Order two no-top Cayenne cabinets to be assembled with common top in the field
- Includes ganging kit for bolting two Low Storage Cabinets together

D	W	Lam. Tops for 2 Cabinets	Pkg Wt	Pkg Cube	Part #	Laminate/Edge #	Price
20	30	(1) 18" stack-on (1) 12" tower	21 lb	.43 ft	CYN 2030K	?	\$368
18	40	(2) 18" stack-ons back-to-back	35 lb	.58 ft	CYN4018K	?	\$402
20	36	(2) 18" cabinets or stack-ons	25 lb	.52 ft	CYN 2036K	?	\$386
20	48	(1) 30" (1) 18" cabinets	34 lb	.69 ft	CYN 2048K	?	\$416
20	54	(1) 36" (1) 18" cabinets	38 lb	.78 ft	CYN 2054K	?	\$470
20	60	(1) 42" (1) 18" cabinets	42 lb	.87 ft	CYN 2060K	?	\$478
20	60	(2) 30" cabinets	22 lb	.7 ft	CYN 2060K	?	\$478
20	66	(1) 30" (1) 36" cabinets	24 lb	.8 ft	CYN 2066K	?	\$483
20	72	(2) 36" cabinets	26 lb	.9 ft	CYN 2072K	?	\$556
20	72	(1) 30" & (1) 42" cabinets	26 lb	.9 ft	CYN 2072K	?	\$556
20	78	(1) 36" & (1) 42" cabinets	28 lb	1.0 ft	CYN 2078K	?	\$584
20	84	(2) 42" cabinets	30 lb	1.0 ft	CYN 2084K	?	\$612

Credenza Center Leg Support

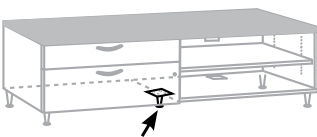

- Create your own credenza by ordering any two Cayenne Low Storage cabinets and then using this Credenza Center Leg Support to:
 - Gang the two cabinets tightly together, side-by-side
 - Eliminate the four legs in the center and replace them with this single support leg
- Must be used in conjunction with a common laminate top (shown above)
- Support leg sits in the center, front-to-back, so it's not visible to users
- Support leg is always round, regardless of the cabinet leg style
- Kit includes splice plate, round center leg, fasteners and instructions

Description	Pkg Wt	Pkg Cube	Part #	Price
one splice plate with center leg	2.5 lb	.16 ft	CYPX 0050K	\$75

Cayenne Ganging Kit

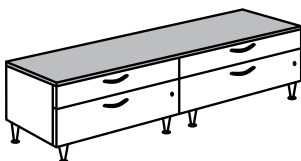

- When sourcing your own Cayenne Low Storage laminate top, use this kit to gang the cabinets together
- Ganging kit includes splice plate, fasteners, and instructions
- Does not include center leg support

Description	Pkg Wt	Pkg Cube	Part #	Price
kit to gang Cayenne cabinets together	1 lb	.2 ft	CSP 01K	\$48

Cushion

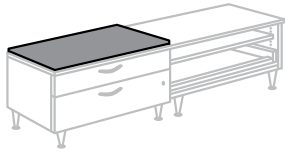

- Foam cushion is 1" thick
- Includes rubber anti-skid material on bottom
- For use on any laminate top cabinet
- Order any standard GO fabric, or COM
- Unless otherwise specified, the fabric grain on all cushions will be applied "front-to-back"

H	D	W	Pkg Wt	Pkg Cube	Part #	Fabric #	GR 1 Price	GR 2 Price	GR 3 Price	GR 4 Price	GR 5 Price	COM Price
1	20	12	4 lb	1.2 ft	NSLP 2012	?	\$185	\$273	\$308	\$343	\$372	\$180
1	20	18	4 lb	1.3 ft	NSLP 2018	?	\$221	\$309	\$343	\$378	\$407	\$215
1	20	30	5 lb	1.5 ft	NSLP 2030	?	\$325	\$450	\$500	\$550	\$591	\$319
1	20	36	6 lb	1.5 ft	NSLP 2036	?	\$370	\$533	\$597	\$662	\$715	\$364
1	20	42	6 lb	1.6 ft	NSLP 2042	?	\$421	\$584	\$649	\$714	\$766	\$416

Magnetic Drawer Dividers - Box Drawer

- Dividers fit inside box lateral drawer bins to create sectioned drawer space
- 16" depth divider fits front-to-back in drawer bin, painted black
- Magnets attach to front and back of drawer bin

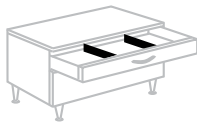

Description	Pkg Wt	Pkg Cube	Part #	Price
pkg of (4) 16" x 4" dividers	22 lb	1.8 ft	LFM 40042K	\$94

Drawer Front Filler - Cayenne

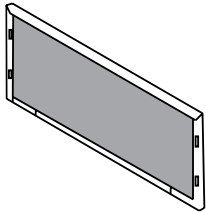

- Cayenne drawers may be upgraded to include a closed cell polyethylene filler piece that adheres to the inside of the drawer front for improved sound dampening
- Drawer Front Filler upgrades, priced per drawer, will be added to the product list price

Description	Pkg Wt	Pkg Cube	Part #	Price Per Drawer
price per drawer	2 lb	.8 ft	Add a "U" as a suffix to the part number	\$64

Available Fronts | A Q | S

Cayenne Towers



- 41-1/2" height matches the finish height of the Stack-on Cube
- Choose from two leg styles, each 3" in height, to match Cayenne cabinet legs
- 12" wide towers include either coat rod or two adjustable shelves
- 18" tower includes coat closet on one side, adjustable shelves on the other
- In 18" towers, the coat closet is always positioned on the hinge side
- For all towers, the hinge may be specified either right or left

H	D	W	Pkg Wt	Pkg Cube	Description	Top	Hinge Location	Part #	Front	Part #	Leg Style	Metal Color	Lam/Edge #	Price
41-1/2	20	12	50 lb	6.8 ft	coat rod	metal	L	LCU	?	U528	?	?	n/a	\$1,492
41-1/2	20	12	50 lb	6.8 ft	coat rod	metal	R	RCU	?	U528	?	?	n/a	\$1,492
41-1/2	20	12	55 lb	6.8 ft	2 shelves	metal	L	LCU	?	U5L9	?	?	n/a	\$1,596
41-1/2	20	12	55 lb	6.8 ft	2 shelves	metal	R	RCU	?	U5L9	?	?	n/a	\$1,596
41-1/2	20	12	56 lb	6.8 ft	coat rod	laminate	L	LCU	?	U528	?	?	?	\$1,819
41-1/2	20	12	56 lb	6.8 ft	coat rod	laminate	R	RCU	?	U528	?	?	?	\$1,819
41-1/2	20	12	60 lb	6.8 ft	2 shelves	laminate	L	LCU	?	U5L9	?	?	?	\$1,947
41-1/2	20	12	60 lb	6.8 ft	2 shelves	laminate	R	RCU	?	U5L9	?	?	?	\$1,947

41-1/2	20	18	75 lb	9.7 ft	closet L	metal	L	LCU	?	U6M4	?	?	n/a	\$1,753
41-1/2	20	18	75 lb	9.7 ft	closet R	metal	R	RCU	?	U6M4	?	?	n/a	\$1,753
41-1/2	20	18	83 lb	9.7 ft	closet L	laminate	L	LCU	?	U6M4	?	?	?	\$2,138
41-1/2	20	18	83 lb	9.7 ft	closet R	laminate	R	RCU	?	U6M4	?	?	?	\$2,138

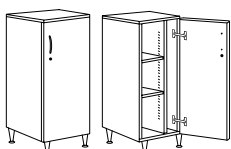
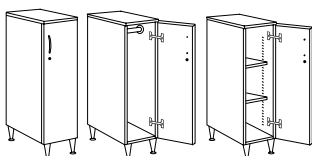

Available Legs S: Round, R: Rectangle

Available Fronts | A Q | S

Work Surfaces

Work surfaces are 1.250" thick with 3mm PVC vinyl edge

Grommets:

Cayenne work surfaces do not include grommets as standard. If a single center grommet is needed (surfaces 24" - 60" wide), simply add a "G" suffix to the part number and add \$15 list to the work surface price. If two grommets are needed (surfaces 66" - 72" wide) add an "LR" suffix to the part number and \$30 list to the work surface price

Grommet locations:

When ordered with grommets, work surfaces will include one center grommet when 60" or less in width, and two grommets when 66" or more in width. Grommets are positioned 18.5" from either side and 2" from the back of the work surface

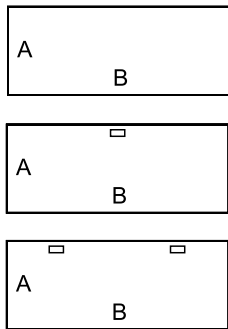

A	B	Pkg Wt	Pkg Cube	Part #	Lam/Edge #	Price
24.0	24.0	20.2 lb	0.4 ft	WS 2424	?	\$366
24.0	30.0	25.2 lb	0.5 ft	WS 2430	?	\$398
24.0	36.0	30.2 lb	0.6 ft	WS 2436	?	\$429
24.0	42.0	35.3 lb	0.7 ft	WS 2442	?	\$487
24.0	48.0	40.3 lb	0.8 ft	WS 2448	?	\$493
24.0	54.0	45.4 lb	0.9 ft	WS 2454	?	\$553
24.0	60.0	50.4 lb	1.0 ft	WS 2460	?	\$556
24.0	66.0	55.4 lb	1.2 ft	WS 2466	?	\$614
24.0	72.0	60.5 lb	1.3 ft	WS 2472	?	\$621
30.0	30.0	31.5 lb	0.7 ft	WS 3030	?	\$445
30.0	36.0	37.8 lb	0.8 ft	WS 3036	?	\$477
30.0	42.0	44.1 lb	0.9 ft	WS 3042	?	\$548
30.0	48.0	50.4 lb	1.0 ft	WS 3048	?	\$557
30.0	54.0	56.7 lb	1.2 ft	WS 3054	?	\$617
30.0	60.0	63.0 lb	1.3 ft	WS 3060	?	\$631
30.0	66.0	69.3 lb	1.4 ft	WS 3066	?	\$702
30.0	72.0	75.6 lb	1.5 ft	WS 3072	?	\$709

Work Surface Stiffeners

Work surfaces that span 60" or more unsupported by legs or a work surface supporting pedestal should include a metal stiffener to prevent sagging. Stiffeners are factory-installed, in-set into the work surface so that there is no interference with pedestals or personal drawers that may be installed underneath

A	B	Pkg Wt	Pkg Cube	Part #	Price
24.0	60.0	50.4 lb	1.0 ft	WS 2460-ST	\$647
24.0	66.0	55.4 lb	1.2 ft	WS 2466-ST	\$705
24.0	72.0	60.5 lb	1.3 ft	WS 2472-ST	\$740
30.0	60.0	63.0 lb	1.3 ft	WS 3060-ST	\$723
30.0	66.0	69.3 lb	1.4 ft	WS 3066-ST	\$793
30.0	72.0	75.6 lb	1.5 ft	WS 3072-ST	\$828

Desk Legs

- Each of the two Cayenne leg styles are available as desk or peninsula legs
- Finish is nickel, which matches the finish on Cayenne cabinet legs
- Includes 5" x 5" mounting plate and fasteners
- Desk leg leveling glides allow for at least 1/2" adjustment



H	Pkg Wt	Pkg Cube	Sold Separately	Part #	Price
27-3/4	13 lb	1.0 ft.	round, quantity of 2	M-TDS 02	\$305
27-3/4	25 lb	2.0 ft	round, quantity of 4	M-TDS 04	\$609



27-3/4	9 lb	1.0 ft	rectangular, quantity of 2	TDR 02	\$305
27-3/4	17 lb	2.0 ft	rectangular, quantity of 4	TDR 04	\$609

Floating Top Support

- Sits on top of Cayenne low storage cabinet with laminate top
- May not be used on a storage cabinet with metal top
- With 5/8" laminate top on the cabinet, and 1-1/4" desk top, desk will finish at 29" high
- No leveling glide adjustability
- Includes top mounting plate with fasteners
- Mounting bracket that sits on the storage cabinet may be secured with double sided tape to avoid scarring the cabinet top. Screws and drill template are also included

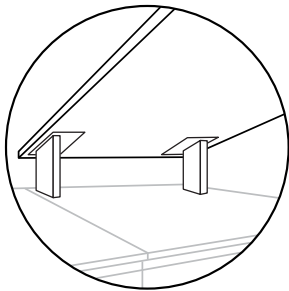

H	D	W	Description	Pkg Wt	Pkg Cube	Part #	Price
5-1/2	1-1/8	2-1/2	two support legs	6.0 lb	0.5 ft	FLTS	\$115

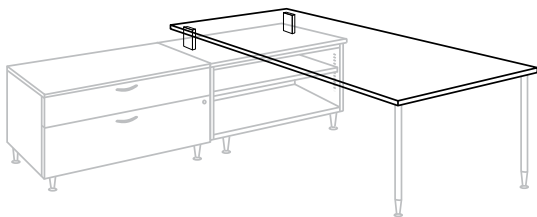

HEIGHT ADJUSTABLE TABLE SPECIFICATIONS

SIN 33721



Basic Construction

- Single stage electric motor
- Speed: 1-1/2" per second, power consumption: 0.3W
- The base height adjusts 19" (480mm), from 26" to 45" (this height does not include the laminate top itself)
- Weight capacity: 220 lbs (does not include work surface)
- Table bases are sold with and without laminate work surface tops
- Laminate top is 1-1/4" thick and does not include grommets
- Corner desks with laminate top are handed. Please specify left or right
- Height adjustable tables require extended lead time, typically 3 weeks

Options and Accessories

- Metal, acrylic, and tackable privacy screens/modesty panels may be attached to laminate work surfaces

Colors

- Height Adjustable Table bases are available in three colors:
 - 02Y9 – HW Silver Metallic
 - 0670 – HM White
 - 0256 – HM Black Umber



HEIGHT ADJUSTABLE TABLES

SIN 33721

Rectangular Table Base with Laminate Top

Table bases are available in three colors:
 02Y9 – HW Silver Metallic
 0670 – HM White
 0256 – HM Black Umber



H	D	W	Part #	Base Color #	Laminate Edge #	Price
27-1/4" to 46-1/4"	24"	48"	HAT2448	?	?	\$2,364
27-1/4" to 46-1/4"	24"	54"	HAT2454	?	?	\$2,403
27-1/4" to 46-1/4"	24"	60"	HAT2460	?	?	\$2,437
27-1/4" to 46-1/4"	24"	72"	HAT2472	?	?	\$2,509
27-1/4" to 46-1/4"	30"	48"	HAT3048	?	?	\$2,427
27-1/4" to 46-1/4"	30"	54"	HAT3054	?	?	\$2,483
27-1/4" to 46-1/4"	30"	60"	HAT3060	?	?	\$2,500
27-1/4" to 46-1/4"	30"	72"	HAT3072	?	?	\$2,583

Corner Table Base with Laminate Top

H	D	W	Part #	L or R	Base Color #	Laminate Edge #	Price
27-1/4" to 46-1/4"	24"	48"/60"	HAT24486024	?	?	?	\$3,714
27-1/4" to 46-1/4"	30"	48"/60"	HAT30486030	?	?	?	\$3,786

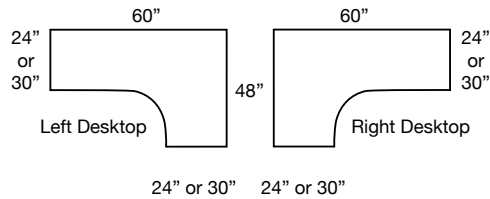
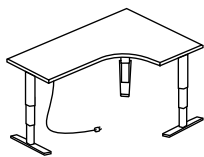

Rectangular Table Base No Top

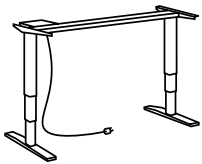

H	D	W	Part #	Base Color #	Price
26" to 45"	24"	48"	HAT2448	?	\$1,706
26" to 45"	24"	54"	HAT2454	?	\$1,722
26" to 45"	24"	60"	HAT2460	?	\$1,733
26" to 45"	24"	72"	HAT2472	?	\$1,760
26" to 45"	30"	48"	HAT3048	?	\$1,717
26" to 45"	30"	54"	HAT3054	?	\$1,733
26" to 45"	30"	60"	HAT3060	?	\$1,744
26" to 45"	30"	72"	HAT3072	?	\$1,772

Corner Table Base No Top (unhanded)

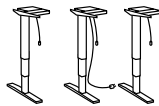

H	D	W	Part #	Base Color #	Price
26" to 45"	24"	48"/60"	HAT246024	?	\$2,230
26" to 45"	30"	48"/60"	HAT306030	?	\$2,246

Desktop Sit-to-Stand



- No tools are required for installation
- Gas assisted height adjustment provides smooth, quiet and infinite height adjustment through a 13.8" range
- The primary work surface is large enough to accommodate 2 x 24" monitors with monitor arms
- Supports 35 lbs. of equipment
- Keyboard surface adjusts for improved ergonomics
- Includes clip on mouse fence and cable manager
- Desktop Sit-to-Stand weighs 40 lbs.
- Two year warranty; tested to 15,000 cycles

H	D	W	Color	Part #	Price
6.2" to 20.0"	23/2"	35.4"	Black	NA24 BK	\$905
6.2" to 20.0"	23/2"	35.4"	White	NA24 WH	\$905

The Trace Freestanding Desk is a modular system of desk shells, returns, bridges, corner units, tables, and individual components that can be mixed and matched with a comprehensive selection of Great Openings storage. All components are shipped knocked down.

Our mission in designing the Freestanding Desk

- **Ease of specification.** All work surfaces rest primarily on panel and corner legs, rather than pedestals. Storage options are innumerable, and simply slide beneath the desk shells, return shells, and corner desks for quick installation
- **Ease of assembly.** All metal attachment points are pre-drilled, so that no “drill point” screws are required during installation. All modesty panels attach to panel legs and corner legs, rather than to pedestals
- **Ease-of-work surface installation.** Pre-drilled work surfaces make it easy to position legs, pedestals, and center drawers
- **Wire management.** Covered metal channels, work surface and panel leg grommets, and “place it yourself” plastic wire management channels provide a complete wire management solution
- **Clean lines.** All modesty panels are single piece, to minimize vertical lines. Desk legs, pedestals, and full height modesty panels are identical in height so that horizontal lines are consistent
- **Horizontal lines consistent with other products.**

Detailed Component Specifications

23" and 29" Panel Leg Specifications

- Panel legs are non handed, and 27-3/4" high when leveling glides are fully recessed. Leveling glides provide 7/8" adjustment
- All panel legs are 1-1/2" wide so that work surface fasteners are positioned within the leg itself, allowing for storage to set snug against the leg
- 23" and 29" panel legs each require one gusset when no modesty panel is present
- Each leg is pre-drilled for both partial and full height modesty panel attachment
- All panel legs include (1) 18" plastic wire management channel that is equipped with adhesive strips and may be attached to a modesty panel, work surface, or storage cabinet
- 23" and 29" panel legs are available with or without two rectangular 3-1/2" x 2" plastic grommets (inside clear dimensions: 2-3/4" x 1-1/2"), positioned at the top of the leg
- Full height metal panel leg covers close-out vertical channels integrated into the panel legs (two per leg), and are sold separately. Each cover includes two grommets, located at top and bottom
- Panel legs and metal wire management covers consist of 20 gauge steel

Corner Leg Specifications

- “L” shaped corner leg is 7-1/2" x 7-1/2", and 1-1/2" wide so that work surface fasteners are positioned within the leg itself
- Corner legs are 27-3/4" high when leveling glides are fully recessed. Leveling glides provide 7/8" adjustment
- Each leg is pre-drilled for both partial and full height modesty attachment
- All corner legs include (1) 18" plastic wire management channel that is equipped with adhesive strips and may be attached to a modesty panel, work surface, or storage cabinet
- Metal wire management cover attaches and removes easily, closing out the triangular leg to capture wires within, and are sold separately
- Corner legs and covers consist of 20 gauge steel

Post Leg

- Post leg 27-3/4" high and 3" in diameter, with adjustable leveling glide
- Each leg is pre-drilled for both partial and full height modesty panel attachment

12" Panel Leg Specifications

- 12" panel legs are designed to sit perpendicular to the edge of the work surface, providing additional support and knee space. 12" panel legs may not be used at the end of work surface runs
- Unlike 23" and 29" panel legs, 12" panel legs do not require gussets when there is no modesty panel because they may not be used at the end of a work surface run
- 12" panel legs may also be used in mid-run to support two work surfaces simultaneously
- Each leg is pre-drilled on both sides for both partial and full height modesty panel attachment, and are unhandled
- All panel legs include (1) 18" plastic wire management channel that is equipped with adhesive strips and may be attached to a modesty panel, work surface, or storage cabinet
- A single grommet is included at the top of each 12" panel leg. Grommets are black plastic, 3-1/2" x 2" (inside clear dimensions: 2-3/4" x 1-1/2")
- A metal wire management cover is included with each 12" panel leg
- Panel legs and covers consist of 20 gauge steel

Gussets

- One gusset is required to support 23" and 29" panel legs when no modesty panel or pedestal positioned adjacent to the panel leg is present
- A gusset will prevent a mobile ped from sitting snugly against the panel leg
- Gussets consist of 18 gauge steel



Critical Dimensions:

Modesty Panel Specifications

- All Trace modesty panels are single-piece construction
- Modesty panels consist of 22 gauge steel, with forms on each edge for added strength and ease of attachment to panel legs and work surfaces

Modesty Panel Offset Brackets

- Modesty panels attach to pre-drilled holes located on the inside edges of panel legs. When a modesty panel must attach to the end of a panel leg, as with a return or bridge, then a modesty panel offset bracket is required to connect pre-drilled attachment points. Modesty panel offset brackets are included with returns and bridges, when ordered with modesty panels and are also sold separately

Work Surface Grommets

All TRACE work surfaces come standard with one or two grommets, which are black plastic with removable covers.

- Rectangular work surfaces 60" and narrower include one grommet in center
- Rectangular work surfaces 66" and wider include two grommets, with grommet center point 20" from each side edge
- Corner desks include one grommet in corner
- Peninsulas include two grommets centered on non-rounded end

Work Surface Over-Hang

Allow for 1/2" overhang on front, back, and sides of all desks. Work surfaces are pre-drilled for proper panel leg positioning

Work Surface Option

For large projects, it is possible to include metal inserts in work surfaces when required for attachment of panel legs, modesty panels, etc. Call for details

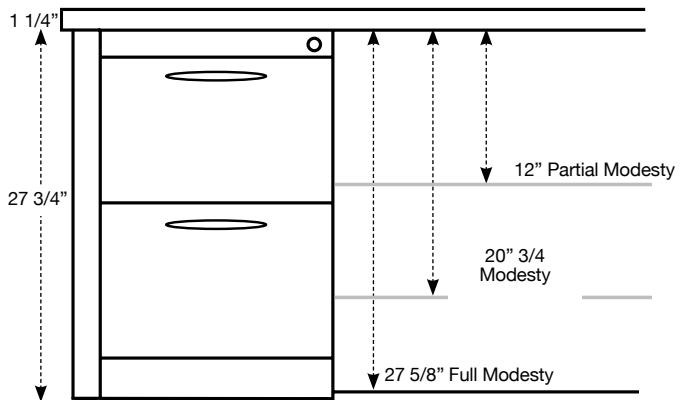

Work Surface Grommets

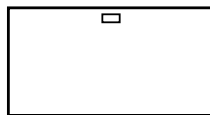
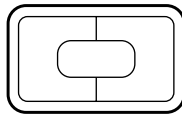
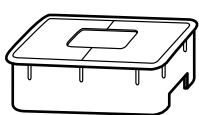

tops 60" or less
1 center grommet

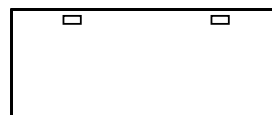

66" or more
2 grommets

- A. Panel leg grommets available as an option with no up-charge
- B. Plastic wire management channels - one 18" channel included with each panel and corner leg
- C. Work surface grommets - one or two grommets included in all work surfaces
- D. Modesty panels in three heights allow wires to run beneath
- E. Wire management channel covers for panel legs & corner legs are sold separately

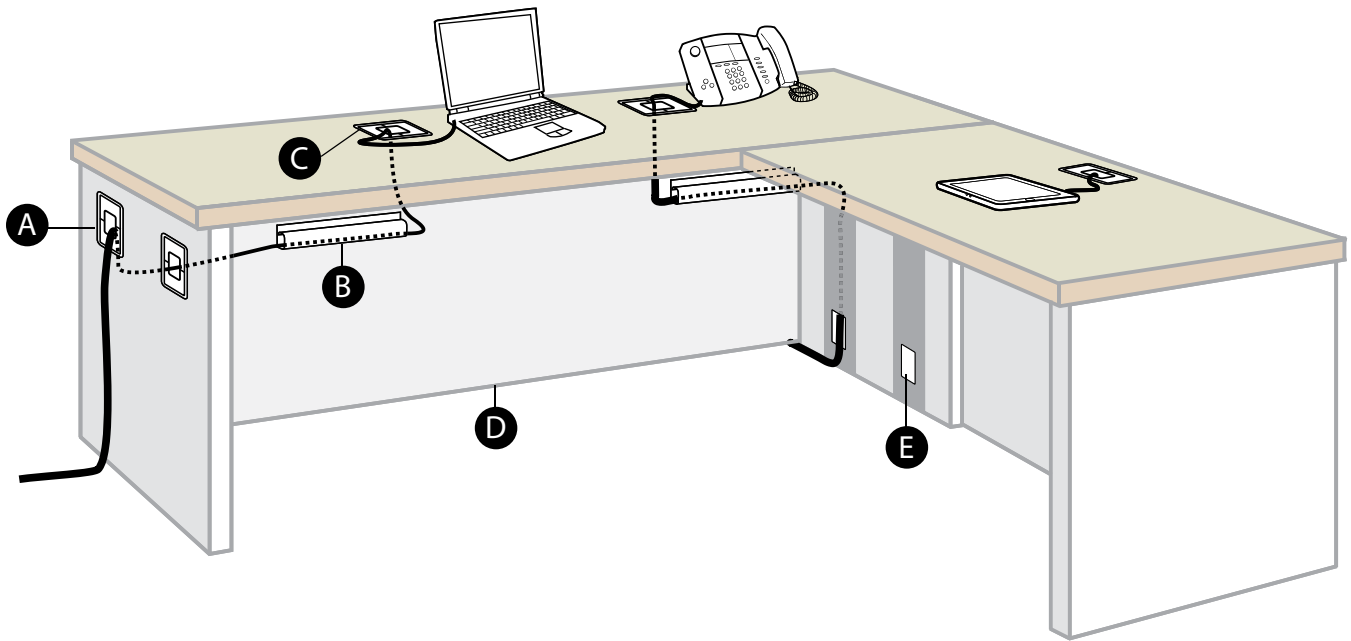

Our objective is to offer you our absolute lowest cost desk: no frills, with only the bare necessities. If you'd prefer a desk with modesty panels, please see our desk shell.

**Bare Bones
Single Pedestal
Desk**

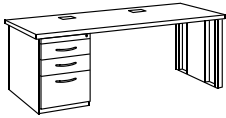

- One top with grommet (tops 60" or less = 1 grommet, 66" or more = 2 grommets)
- One pedestal with counterweight
- One panel leg with gusset
- No modesty panel
- Plastic wire management channel included with panel leg

H	D	W	Ped Depth	Drawer Options	Part #	Front	Part #	Metal Color	Lam/Edge #	Price
29	24	48	22	file/file	BBS	?	2 2448	?	?	\$1,527
				box/box/file	BBS	?	3 2448	?	?	\$1,569
29	24	54	22	file/file	BBS	?	2 2454	?	?	\$1,576
				box/box/file	BBS	?	3 2454	?	?	\$1,626
29	24	60	22	file/file	BBS	?	2 2460	?	?	\$1,634
				box/box/file	BBS	?	3 2460	?	?	\$1,679
29	24	66	22	file/file	BBS	?	2 2466	?	?	\$1,693
				box/box/file	BBS	?	3 2466	?	?	\$1,729
29	24	72	22	file/file	BBS	?	2 2472	?	?	\$1,707
				box/box/file	BBS	?	3 2472	?	?	\$1,758
29	30	48	28	file/file	BBS	?	2 3048	?	?	\$1,772
				box/box/file	BBS	?	3 3048	?	?	\$1,831
29	30	54	28	file/file	BBS	?	2 3054	?	?	\$1,808
				box/box/file	BBS	?	3 3054	?	?	\$1,867
29	30	60	28	file/file	BBS	?	2 3060	?	?	\$1,852
				box/box/file	BBS	?	3 3060	?	?	\$1,904
29	30	66	28	file/file	BBS	?	2 3066	?	?	\$1,895
				box/box/file	BBS	?	3 3066	?	?	\$1,932
29	30	72	28	file/file	BBS	?	2 3072	?	?	\$1,953
				box/box/file	BBS	?	3 3072	?	?	\$2,004

Available Fronts | A | B | D | F | H | I | N | P | Q | S

**Bare Bones
Double Pedestal
Desk**

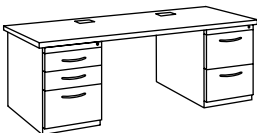

- One top with grommet (tops 60" or less = 1 grommet, 66" or more = 2 grommets)
- Two pedestals with counterweight
- One file/file, one box/box/file
- No panel legs
- No modesty panel

H	D	W	Ped Depth	Drawer Options	Part #	Front	Part #	Metal Color	Lam/Edge #	Price
29	24	60	22	one each	BBD	?	5 2460	?	?	\$1,651
29	24	66	22	one each	BBD	?	5 2466	?	?	\$1,689
29	24	72	22	one each	BBD	?	5 2472	?	?	\$1,726
29	30	60	28	one each	BBD	?	5 3060	?	?	\$1,781
29	30	66	28	one each	BBD	?	5 3066	?	?	\$1,814
29	30	72	28	one each	BBD	?	5 3072	?	?	\$1,848

Available Fronts | A | B | D | F | H | I | N | P | Q | S

**Bare Bones
Single Pedestal
Return**

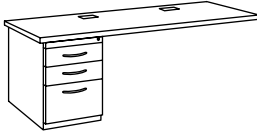

- One top with grommet (tops 60" or less = 1 grommet, 66" or more = 2 grommets)
- One pedestal with counterweight
- Two splice plates
- No panel legs
- No modesty panel

H	D	W	Ped Depth	Drawer Options	Part #	Front	Part #	Metal Color	Lam/Edge #	Price
29	24	30	22	file/file	BBR	?	2 2430	?	?	\$919
				box/box/file	BBR	?	3 2430	?	?	\$977
29	24	36	22	file/file	BBR	?	2 2436	?	?	\$950
				box/box/file	BBR	?	3 2436	?	?	\$1,008
29	24	42	22	file/file	BBR	?	2 2442	?	?	\$1,007
				box/box/file	BBR	?	3 2442	?	?	\$1,064
29	24	48	22	file/file	BBR	?	2 2448	?	?	\$1,012
				box/box/file	BBR	?	3 2448	?	?	\$1,070
29	24	60	22	file/file	BBR	?	2 2460	?	?	\$1,074
				box/box/file	BBR	?	3 2460	?	?	\$1,132
29	24	66	22	file/file	BBR	?	2 2466	?	?	\$1,113
				box/box/file	BBR	?	3 2466	?	?	\$1,170
29	24	72	22	file/file	BBR	?	2 2472	?	?	\$1,150
				box/box/file	BBR	?	3 2472	?	?	\$1,208

Available Fronts	A	B	D	F	H	I	N	P	Q	S
------------------	---	---	---	---	---	---	---	---	---	---

**Desk Shell
– No Modesty**

- One top with grommets (tops 60" or less = 1 center grommet, 66" or more = 2 grommets)
- Two panel legs (panel leg grommets optional, no up-charge)
- 36" work surfaces will include 29" panel legs, with 6" work surface overhang
- Two gussets (one per panel leg)
- No modesty panel
- Plastic wire management channels
- A gusset will prevent a mobile ped from sitting snugly against the panel leg
- Bow front work surfaces have a 6-1/2" overhang in the center

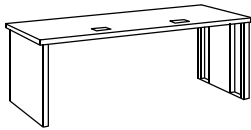

H	D	W	Part #	* = No grommet G= grommet	No Modesty	Metal Color	Lam/Edge	Price
29	24	30	DK 2430	?	N	?	?	\$1,089
29	24	36	DK 2436	?	N	?	?	\$1,118
29	24	42	DK 2442	?	N	?	?	\$1,176
29	24	48	DK 2448	?	N	?	?	\$1,191
29	24	54	DK 2454	?	N	?	?	\$1,220
29	24	60	DK 2460	?	N	?	?	\$1,263
29	24	66	DK 2466	?	N	?	?	\$1,329
29	24	72	DK 2472	?	N	?	?	\$1,350
29	30	30	DK 3030	?	N	?	?	\$1,236
29	30	36	DK 3036	?	N	?	?	\$1,236
29	30	42	DK 3042	?	N	?	?	\$1,286
29	30	48	DK 3048	?	N	?	?	\$1,307
29	30	54	DK 3054	?	N	?	?	\$1,358
29	30	60	DK 3060	?	N	?	?	\$1,403
29	30	66	DK 3066	?	N	?	?	\$1,446
29	30	72	DK 3072	?	N	?	?	\$1,504
29	36	48	DK 3648	?	N	?	?	\$1,446
29	36	60	DK 3660	?	N	?	?	\$1,496
29	36	66	DK 3666	?	N	?	?	\$1,584
29	36	72	DK 3672	?	N	?	?	\$1,642
29	36	72 (bow)	BDK 3672	?	N	?	?	\$1,672

**Desk Shell
– Partial
Modesty**

- One top with grommets (tops 60" or less = 1 center grommet, 66" or more = 2 grommets)
- Two panel legs (panel leg grommets optional, no up-charge)
- 36" work surfaces will include 29" panel legs, with 6" work surface overhang
- Partial modesty panel is 12" tall, raised 17" from floor
- Modesty height designed to allow easy access to electrical outlets
- Plastic wire management channels
- Bow front work surfaces have a 6-1/2" overhang in the center

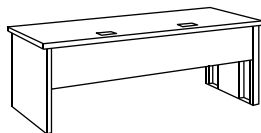

Hanging pedestals do not match the height of this modesty panel. Use 3/4 Modesty panel on next page.

H	D	W	Part #	* = No grommet G= grommet	Partial Modesty	Metal Color	Lam/Edge	Price
29	24	30	DK 2430	?	P	?	?	\$1,105
29	24	36	DK 2436	?	P	?	?	\$1,140
29	24	42	DK 2442	?	P	?	?	\$1,213
29	24	48	DK 2448	?	P	?	?	\$1,229
29	24	54	DK 2454	?	P	?	?	\$1,285
29	24	60	DK 2460	?	P	?	?	\$1,321
29	24	66	DK 2466	?	P	?	?	\$1,388
29	24	72	DK 2472	?	P	?	?	\$1,416
29	30	30	DK 3030	?	P	?	?	\$1,258
29	30	36	DK 3036	?	P	?	?	\$1,265
29	30	42	DK 3042	?	P	?	?	\$1,315
29	30	48	DK 3048	?	P	?	?	\$1,343
29	30	54	DK 3054	?	P	?	?	\$1,395
29	30	60	DK 3060	?	P	?	?	\$1,452
29	30	66	DK 3066	?	P	?	?	\$1,510
29	30	72	DK 3072	?	P	?	?	\$1,569
29	36	48	DK 3648	?	P	?	?	\$1,489
29	36	60	DK 3660	?	P	?	?	\$1,570
29	36	66	DK 3666	?	P	?	?	\$1,642
29	36	72	DK 3672	?	P	?	?	\$1,707
29	36	72 (bow)	BDK 3672	?	P	?	?	\$1,729

Desk Shell – 3/4 Modesty

- 3/4 modesty bottom is even with hanging box/file ped
- One top with grommets (tops 60" or less = 1 center grommet, 66" or more = 2 grommets)
- Two panel legs (panel leg grommets optional, no up-charge)
- Plastic wire management channels

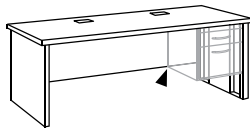
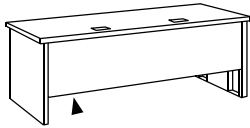

H	D	W	Part #	* = No grommet G= grommet	3/4 Height Modesty	Metal Color	Lam/Edge	Price
29	24	30	DK 2430	?	T	?	?	\$1,120
29	24	36	DK 2436	?	T	?	?	\$1,157
29	24	42	DK 2442	?	T	?	?	\$1,232
29	24	48	DK 2448	?	T	?	?	\$1,247
29	24	54	DK 2454	?	T	?	?	\$1,305
29	24	60	DK 2460	?	T	?	?	\$1,341
29	24	66	DK 2466	?	T	?	?	\$1,409
29	24	72	DK 2472	?	T	?	?	\$1,437
29	30	30	DK 3030	?	T	?	?	\$1,276
29	30	36	DK 3036	?	T	?	?	\$1,283
29	30	42	DK 3042	?	T	?	?	\$1,334
29	30	48	DK 3048	?	T	?	?	\$1,364
29	30	54	DK 3054	?	T	?	?	\$1,415
29	30	60	DK 3060	?	T	?	?	\$1,474
29	30	66	DK 3066	?	T	?	?	\$1,533
29	30	72	DK 3072	?	T	?	?	\$1,592

Desk Shell – Full Modesty

- One top with grommets (tops 60" or less = 1 center grommet, 66" or more = 2 grommets)
- Two panel legs (panel leg grommets optional, no up-charge)
- 36" work surfaces will include 29" panel legs, with 6" work surface overhang
- Full height modesty panel is 27-5/8" tall, raised 1/2" from floor
- Plastic wire management channels
- Bow front work surfaces have a 6-1/2" overhang in the center

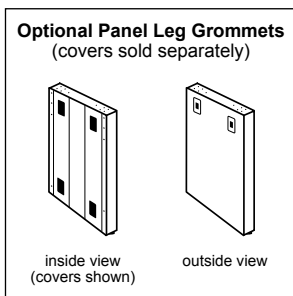
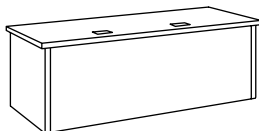

H	D	W	Part #	* = No grommet G= grommet	Full Modesty	Metal Color	Lam/Edge	Price
29	24	30	DK 2430	?	F	?	?	\$1,133
29	24	36	DK 2436	?	F	?	?	\$1,177
29	24	42	DK 2442	?	F	?	?	\$1,257
29	24	48	DK 2448	?	F	?	?	\$1,279
29	24	54	DK 2454	?	F	?	?	\$1,316
29	24	60	DK 2460	?	F	?	?	\$1,372
29	24	66	DK 2466	?	F	?	?	\$1,454
29	24	72	DK 2472	?	F	?	?	\$1,489
29	30	30	DK 3030	?	F	?	?	\$1,286
29	30	36	DK 3036	?	F	?	?	\$1,301
29	30	42	DK 3042	?	F	?	?	\$1,358
29	30	48	DK 3048	?	F	?	?	\$1,395
29	30	54	DK 3054	?	F	?	?	\$1,439
29	30	60	DK 3060	?	F	?	?	\$1,510
29	30	66	DK 3066	?	F	?	?	\$1,569
29	30	72	DK 3072	?	F	?	?	\$1,642
29	36	48	DK 3648	?	F	?	?	\$1,533
29	36	60	DK 3660	?	F	?	?	\$1,613
29	36	66	DK 3666	?	F	?	?	\$1,715
29	36	72	DK 3672	?	F	?	?	\$1,780
29	36	72 (bow)	BDK 3672	?	F	?	?	\$1,810

**Return Shell
– No Modesty**

- One top with grommets (tops 60" or less = 1 center grommet, 66" or more = 2 grommets)
- One panel leg (panel leg grommets optional, no up-charge)
- No modesty panel
- Two splice plates
- One gusset
- Plastic wire management channel
- Non-handed

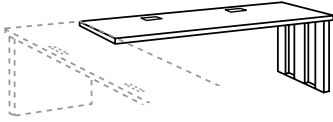

H	D	W	Part #	* = No grommet G= grommet	No Modesty	Metal Color	Lam/Edge #	Price
29	24	24	RT 2424	?	N	?	?	\$811
29	24	30	RT 2430	?	N	?	?	\$828
29	24	36	RT 2436	?	N	?	?	\$865
29	24	42	RT 2442	?	N	?	?	\$922
29	24	48	RT 2448	?	N	?	?	\$931
29	24	54	RT 2454	?	N	?	?	\$949
29	24	60	RT 2460	?	N	?	?	\$1,003
29	24	66	RT 2466	?	N	?	?	\$1,068
29	24	72	RT 2472	?	N	?	?	\$1,097
29	30	30	RT 3030	?	N	?	?	\$960
29	30	36	RT 3036	?	N	?	?	\$960
29	30	42	RT 3042	?	N	?	?	\$1,002
29	30	48	RT 3048	?	N	?	?	\$1,031
29	30	54	RT 3054	?	N	?	?	\$1,074
29	30	60	RT 3060	?	N	?	?	\$1,118
29	30	66	RT 3066	?	N	?	?	\$1,162
29	30	72	RT 3072	?	N	?	?	\$1,220

**Return Shell
– Partial Modesty**

- One top with grommets (tops 60" or less = 1 center grommet, 66" or more = 2 grommets)
- One panel leg (panel leg grommets optional, no up-charge)
- Partial modesty is 12" tall, raised 17" from the floor
- Two splice plates
- Modesty panel
- Modesty panel offset brackets
- Plastic wire management channel
- Non-handed

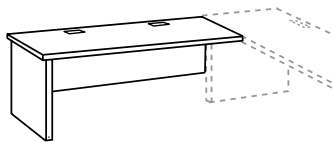

H	D	W	Part #	* = No grommet G= grommet	Partial Modesty	Metal Color	Lam/Edge #	Price
29	24	24	RT 2424	?	P	?	?	\$827
29	24	30	RT 2430	?	P	?	?	\$851
29	24	36	RT 2436	?	P	?	?	\$894
29	24	42	RT 2442	?	P	?	?	\$960
29	24	48	RT 2448	?	P	?	?	\$974
29	24	54	RT 2454	?	P	?	?	\$1,007
29	24	60	RT 2460	?	P	?	?	\$1,038
29	24	66	RT 2466	?	P	?	?	\$1,113
29	24	72	RT 2472	?	P	?	?	\$1,141
29	30	30	RT 3030	?	P	?	?	\$981
29	30	36	RT 3036	?	P	?	?	\$988
29	30	42	RT 3042	?	P	?	?	\$1,038
29	30	48	RT 3048	?	P	?	?	\$1,061
29	30	54	RT 3054	?	P	?	?	\$1,116
29	30	60	RT 3060	?	P	?	?	\$1,170
29	30	66	RT 3066	?	P	?	?	\$1,213
29	30	72	RT 3072	?	P	?	?	\$1,279

TRACE DESKS

SIN 33721

Return Shell – Full Modesty

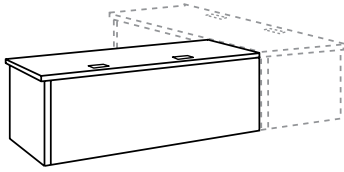

- One top with grommets (tops 60" or less = 1 center grommet, 66" or more = 2 grommets)
- One panel leg (panel leg grommets optional, no up-charge)
- Full modesty is 27-5/8" tall, raised 1/2" from the floor
- Two splice plates
- Modesty panel offset brackets
- Plastic wire management channel
- Non-handed

Optional Panel Leg
Grommets
(covers sold
separately)

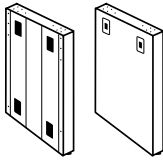

inside view
(covers shown) outside view

H	D	W	Part #	* = No grommet G= grommet	Full Modesty	Metal Color	Lam/Edge #	Price
29	24	24	RT 2424	?	F	?	?	\$863
29	24	30	RT 2430	?	F	?	?	\$885
29	24	36	RT 2436	?	F	?	?	\$929
29	24	42	RT 2442	?	F	?	?	\$1,002
29	24	48	RT 2448	?	F	?	?	\$1,025
29	24	54	RT 2454	?	F	?	?	\$1,075
29	24	60	RT 2460	?	F	?	?	\$1,127
29	24	66	RT 2466	?	F	?	?	\$1,206
29	24	72	RT 2472	?	F	?	?	\$1,243
29	30	30	RT 3030	?	F	?	?	\$1,010
29	30	36	RT 3036	?	F	?	?	\$1,025
29	30	42	RT 3042	?	F	?	?	\$1,082
29	30	48	RT 3048	?	F	?	?	\$1,127
29	30	54	RT 3054	?	F	?	?	\$1,184
29	30	60	RT 3060	?	F	?	?	\$1,243
29	30	66	RT 3066	?	F	?	?	\$1,294
29	30	72	RT 3072	?	F	?	?	\$1,365

Spec Guide Personal Storage Pedestals Laterals Lockers Towers Storage Cabinets Bookcases Cayenne Ht Adj Tables **Trace Desk** Desk Accessories Sparkology Terms/Conds

“D” & “P” Peninsula – No Modesty

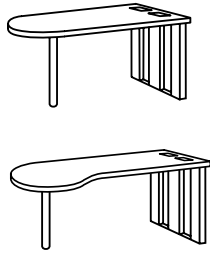

When adding a return, bridge, or peninsula to a single ped desk (L-Station), the single ped desk should be at least 66" wide to leave adequate knee space. Peninsulas are not freestanding units; they must attach to bridge, desk shell, or return.

- One top with grommets
- One post leg
- One panel leg (panel leg grommets optional, no up-charge)
- One gusset
- No modesty panel
- Plastic wire management channel

H	A	B	C	Top Shape	Part #	* = No grommet G= grommet	No Modesty	Metal Color	Lam/ Edge #	Price
29	30	60	30	“D”	PD 3060	?	N	?	?	\$1,301
29	30	66	30	“D”	PD 3066	?	N	?	?	\$1,416
29	30	72	30	“D”	PD 3072	?	N	?	?	\$1,424
29	30	60	36	“P” left	PNL 3060	?	N	?	?	\$1,758
29	30	66	36	“P” left	PNL 3066	?	N	?	?	\$1,867
29	30	72	36	“P” left	PNL 3072	?	N	?	?	\$1,874
29	30	60	36	“P” right	PNR 3060	?	N	?	?	\$1,758
29	30	66	36	“P” right	PNR 3066	?	N	?	?	\$1,867
29	30	72	36	“P” right	PNR 3072	?	N	?	?	\$1,874

“D” & “P” Peninsula – Partial Modesty

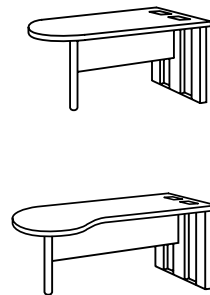

- One top with grommets
- One post leg
- One panel leg (panel leg grommets optional, no up-charge)
- Partial height modesty panel is 12" tall, raised 17" from floor
- Plastic wire management channel

H	A	B	C	Top Shape	Part #	* = No grommet G= grommet	Partial Modesty	Metal Color	Lam/ Edge #	Price
29	30	60	30	“D”	PD 3060	?	P	?	?	\$1,388
29	30	66	30	“D”	PD 3066	?	P	?	?	\$1,504
29	30	72	30	“D”	PD 3072	?	P	?	?	\$1,525
29	30	60	36	“P” left	PNL 3060	?	P	?	?	\$1,846
29	30	66	36	“P” left	PNL 3066	?	P	?	?	\$1,953
29	30	72	36	“P” left	PNL 3072	?	P	?	?	\$1,969
29	30	60	36	“P” right	PNR 3060	?	P	?	?	\$1,846
29	30	66	36	“P” right	PNR 3066	?	P	?	?	\$1,953
29	30	72	36	“P” right	PNR 3072	?	P	?	?	\$1,969

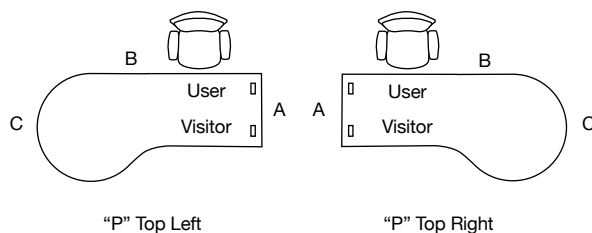

Optional Panel Leg Grommets (covers sold separately)

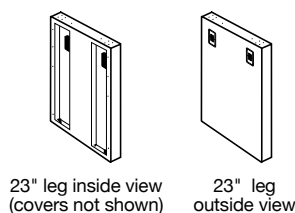

Corner – No Modesty

- One top with grommet
- One corner leg
- Two 12" panel legs include grommet and panel leg covers
- No modesty panels
- Plastic wire management channels

A corner may not be used as a stand-alone or end-of-run desk; it must be attached on both sides to a bridge or return.

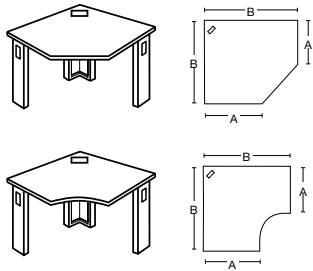

H	A	B	User Edge	Part #	Metal Color	Lam/Edge #	Price
29	24	36	straight	CS 2436 N	?	?	\$1,576
29	24	42	straight	CS 2442 N	?	?	\$1,757
29	24	48	straight	CS 2448 N	?	?	\$1,779
29	24	36	curved	CC 2436 N	?	?	\$1,576
29	24	42	curved	CC 2442 N	?	?	\$1,757
29	24	48	curved	CC 2448 N	?	?	\$1,779

Corner – Partial Modesty

- One top with grommet
- One corner leg
- Two 12" panel legs include grommet and panel leg covers
- Partial height modesty panels are 12" tall, raised 17" from the floor
- Plastic wire management channels

A corner may not be used as a stand-alone or end-of-run desk; it must be attached on both sides to a bridge or return.

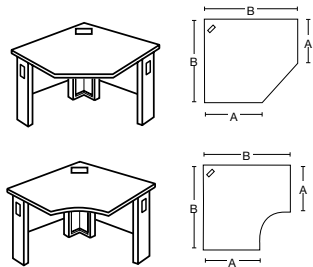

H	A	B	User Edge	Part #	Metal Color	Lam/Edge #	Price
29	24	36	straight	CS 2436 P	?	?	\$1,824
29	24	42	straight	CS 2442 P	?	?	\$2,012
29	24	48	straight	CS 2448 P	?	?	\$2,049
29	24	36	curved	CC 2436 P	?	?	\$1,824
29	24	42	curved	CC 2442 P	?	?	\$2,012
29	24	48	curved	CC 2448 P	?	?	\$2,049

Corner – Full Modesty

- One top with grommet
- One corner leg
- Two 12" panel legs include grommet and panel leg covers
- Full height modesty panels are 27-5/8" tall, raised 1/2" from the floor
- Plastic wire management channels

A corner may not be used as a stand-alone or end-of-run desk; it must be attached on both sides to a bridge or return.

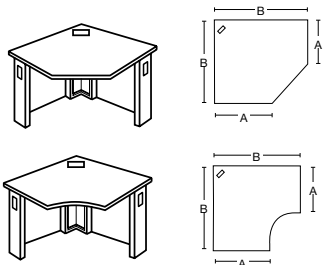

H	A	B	User Edge	Part #	Metal Color	Lam/Edge #	Price
29	24	36	straight	CS 2436 F	?	?	\$1,882
29	24	42	straight	CS 2442 F	?	?	\$2,084
29	24	48	straight	CS 2448 F	?	?	\$2,137
29	24	36	curved	CC 2436 F	?	?	\$1,882
29	24	42	curved	CC 2442 F	?	?	\$2,084
29	24	48	curved	CC 2448 F	?	?	\$2,137

Corner Leg Wire Management Cover

- Metal cover closes out the triangular corner legs to safely enclose cables. Magnetic attachment allows for easy removal and replacement
- Please specify color

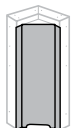

Product	Qty	Part #	Price
Corner Leg Cover (Specify Color)	Pkg. of 1 cover	GOC 151 K ?	\$68

TRACE DESKS

SIN 33721

Extended Corner No Modesty

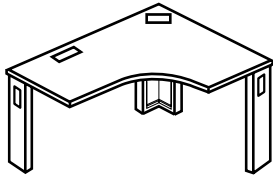

An extended corner that does not include an end-of-run 24" or 30" deep panel leg (see next page) may not be used as a stand-alone desk, it must be attached to a bridge or return on both sides. For end-of-run applications, see the following page.

- One top with grommet
- One corner leg, two 12" panel legs
- Two 12" panel legs include grommet and panel leg covers
- No modesty panels
- Plastic wire management channels

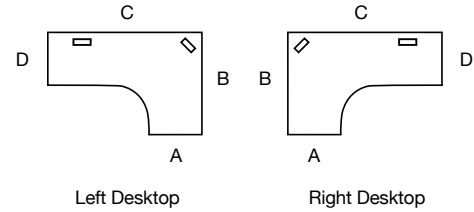

H	A	B	C	D	Part #	L/R	Part #	Metal Color	Lam/Edge #	Price
29	24	48	60	24	ET	L/R	24 60 24 N	?	?	\$2,192
29	24	48	66	24	ET	L/R	24 66 24 N	?	?	\$2,243
29	24	48	72	24	ET	L/R	24 72 24 N	?	?	\$2,325
29	24	48	60	30	ET	L/R	24 60 30 N	?	?	\$2,192
29	24	48	66	30	ET	L/R	24 66 30 N	?	?	\$2,243
29	24	48	72	30	ET	L/R	24 72 30 N	?	?	\$2,325
29	30	48	60	24	ET	L/R	30 60 24 N	?	?	\$2,192
29	30	48	66	24	ET	L/R	30 66 24 N	?	?	\$2,243
29	30	48	72	24	ET	L/R	30 72 24 N	?	?	\$2,325
29	30	48	60	30	ET	L/R	30 60 30 N	?	?	\$2,192
29	30	48	66	30	ET	L/R	30 66 30 N	?	?	\$2,243
29	30	48	72	30	ET	L/R	30 72 30 N	?	?	\$2,325

Extended Corner Partial Modesty

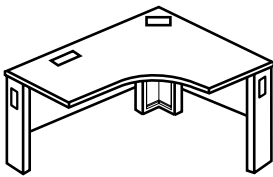

- One top with grommet
- One corner leg, two 12" panel legs
- Two 12" panel legs include grommet and panel leg covers
- Partial height modesty panels are 12" tall, raised 17" from floor
- Plastic wire management channels

H	A	B	C	D	Part #	L/R	Part #	Metal Color	Lam/Edge #	Price
29	24	48	60	24	ET	L/R	24 60 24 P	?	?	\$2,470
29	24	48	66	24	ET	L/R	24 66 24 P	?	?	\$2,538
29	24	48	72	24	ET	L/R	24 72 24 P	?	?	\$2,615
29	24	48	60	30	ET	L/R	24 60 30 P	?	?	\$2,470
29	24	48	66	30	ET	L/R	24 66 30 P	?	?	\$2,538
29	24	48	72	30	ET	L/R	24 72 30 P	?	?	\$2,615
29	30	48	60	24	ET	L/R	30 60 24 P	?	?	\$2,470
29	30	48	66	24	ET	L/R	30 66 24 P	?	?	\$2,538
29	30	48	72	24	ET	L/R	30 72 24 P	?	?	\$2,615
29	30	48	60	30	ET	L/R	30 60 30 P	?	?	\$2,470
29	30	48	66	30	ET	L/R	30 66 30 P	?	?	\$2,538
29	30	48	72	30	ET	L/R	30 72 30 P	?	?	\$2,615

Extended Corner Full Modesty

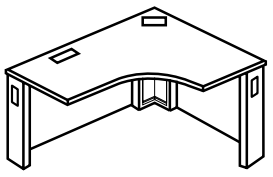

- One top with grommet
- One corner leg, two 12" panel legs
- Two 12" panel legs include grommet and panel leg covers
- Full height modesty panels are 27-5/8" tall, raised 1/2" from floor
- Plastic wire management channels

H	A	B	C	D	Part #	L/R	Part #	Metal Color	Lam/Edge #	Price
29	24	48	60	24	ET	L/R	24 60 24 F	?	?	\$2,571
29	24	48	66	24	ET	L/R	24 66 24 F	?	?	\$2,650
29	24	48	72	24	ET	L/R	24 72 24 F	?	?	\$2,731
29	24	48	60	30	ET	L/R	24 60 30 F	?	?	\$2,571
29	24	48	66	30	ET	L/R	24 66 30 F	?	?	\$2,650
29	24	48	72	30	ET	L/R	24 72 30 F	?	?	\$2,731
29	30	48	60	24	ET	L/R	30 60 24 F	?	?	\$2,571
29	30	48	66	24	ET	L/R	30 66 24 F	?	?	\$2,650
29	30	48	72	24	ET	L/R	30 72 24 F	?	?	\$2,731
29	30	48	60	30	ET	L/R	30 60 30 F	?	?	\$2,571
29	30	48	66	30	ET	L/R	30 66 30 F	?	?	\$2,650
29	30	48	72	30	ET	L/R	30 72 30 F	?	?	\$2,731

Spec Guide Personal Storage Pedestals Laterals Lockers Towers Storage Cabinets Bookcases Cayenne Ht Adj Tables Trace Desk Desk Accessories Sparkteology Terms/Conds

End-of-run corners are designed with a 23" or 29" panel leg located on the "D" side of the corner desk. This panel allows desking runs to be terminated at the corner in a way that ensures stability and offers a clean, finished look. An end-of-run may be used as an end run, it must be attached to a bridge or return on the side with the 12" panel leg.

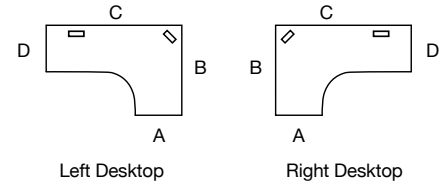

End-of-Run Extended Corner - No Modesty

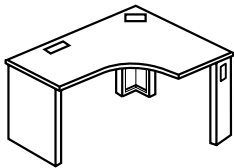

- One top with grommet
- One corner leg, one 12" panel leg, and one 23" or 29" panel leg
- No modesty panels
- Plastic wire management channels
- One gusset

H	A	B	C	D	Part #	L/R	Part #	Metal Color	Lam/Edge #	Price
29	24	48	60	24	ED	L/R	24 60 24 N	?	?	\$2,354
29	24	48	66	24	ED	L/R	24 66 24 N	?	?	\$2,410
29	24	48	72	24	ED	L/R	24 72 24 N	?	?	\$2,472
29	24	48	60	30	ED	L/R	24 60 30 N	?	?	\$2,370
29	24	48	66	30	ED	L/R	24 66 30 N	?	?	\$2,445
29	24	48	72	30	ED	L/R	24 72 30 N	?	?	\$2,494
29	30	48	60	24	ED	L/R	30 60 24 N	?	?	\$2,370
29	30	48	60	24	ED	L/R	30 66 24 N	?	?	\$2,439
29	30	48	72	24	ED	L/R	30 72 24 N	?	?	\$2,493
29	30	48	60	30	ED	L/R	30 60 30 N	?	?	\$2,391
29	30	48	66	30	ED	L/R	30 66 30 N	?	?	\$2,475
29	30	48	72	30	ED	L/R	30 72 30 N	?	?	\$2,513

End-of-Run Extended Corner - Partial Modesty

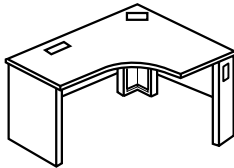

- One top with grommet
- One corner leg, one 12" panel leg, and one 23" or 29" panel leg
- Partial height modesty panels are 12" tall, raised 17" from floor
- Plastic wire management channels

H	A	B	C	D	Part #	L/R	Part #	Metal Color	Lam/Edge #	Price
29	24	48	60	24	ED	L/R	24 60 24 P	?	?	\$2,628
29	24	48	60	24	ED	L/R	24 66 24 P	?	?	\$2,695
29	24	48	72	24	ED	L/R	24 72 24 P	?	?	\$2,764
29	24	48	60	30	ED	L/R	24 60 30 P	?	?	\$2,647
29	24	48	66	30	ED	L/R	24 66 30 P	?	?	\$2,714
29	24	48	72	30	ED	L/R	24 72 30 P	?	?	\$2,784
29	30	48	60	24	ED	L/R	30 60 24 P	?	?	\$2,628
29	30	48	66	24	ED	L/R	30 66 24 P	?	?	\$2,729
29	30	48	72	24	ED	L/R	30 72 24 P	?	?	\$2,764
29	30	48	60	30	ED	L/R	30 60 30 P	?	?	\$2,647
29	30	48	66	30	ED	L/R	30 66 30 P	?	?	\$2,749
29	30	48	72	30	ED	L/R	30 72 30 P	?	?	\$2,781

End-of-Run Extended Corner - Full Modesty

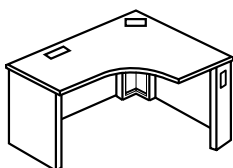

- One top with grommet
- One corner leg, one 12" panel leg, and one 23" or 29" panel leg
- Full height modesty panels are 27-5/8" tall, raised 1/2" from floor
- Plastic wire management channels

H	A	B	C	D	Part #	L/R	Part #	Metal Color	Lam/Edge #	Price
29	24	48	60	24	ED	L/R	24 60 24 F	?	?	\$2,731
29	24	48	66	24	ED	L/R	24 66 24 F	?	?	\$2,805
29	24	48	72	24	ED	L/R	24 72 24 F	?	?	\$2,888
29	24	48	60	30	ED	L/R	24 60 30 F	?	?	\$2,751
29	24	48	66	30	ED	L/R	24 66 30 F	?	?	\$2,838
29	24	48	72	30	ED	L/R	24 72 30 F	?	?	\$2,907
29	30	48	60	24	ED	L/R	30 60 24 F	?	?	\$2,731
29	30	48	66	24	ED	L/R	30 66 24 F	?	?	\$2,805
29	30	48	72	24	ED	L/R	30 72 24 F	?	?	\$2,888
29	30	48	60	30	ED	L/R	30 60 30 F	?	?	\$2,751
29	30	48	66	30	ED	L/R	30 66 30 F	?	?	\$2,829
29	30	48	72	30	ED	L/R	30 72 30 F	?	?	\$2,907

TRACE DESKS

SIN 33721

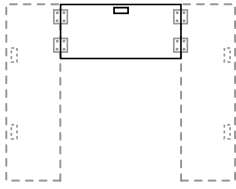

Bridges attach to desk shells, single pedestal desks, corner desks, and peninsulas to form a U-shaped configuration. Bridges cannot attach to returns or single pedestal returns. When adding a bridge to a single pedestal desk (L-Station), the single pedestal desk should be at least 66" wide to leave adequate knee space.

Bridge – No Modesty

- One top with grommet (tops 60" or less = 1 center grommet, 66" or more = 2 grommets)
- Four splice plates
- No modesty panels

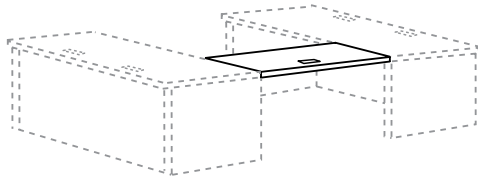

H	D	W	Part #	Lam/ Edge #	Price
29	24	24	BR 2424 N	?	\$450
29	24	30	BR 2430 N	?	\$471
29	24	36	BR 2436 N	?	\$501
29	24	42	BR 2442 N	?	\$566
29	24	48	BR 2448 N	?	\$574
29	24	60	BR 2460 N	?	\$646
29	24	66	BR 2466 N	?	\$713
29	24	72	BR 2472 N	?	\$740

Bridge – Partial Modesty

- One top with grommet (tops 60" or less = 1 center grommet, 66" or more = 2 grommets)
- Four splice plates
- Partial height modesty panels are 12" tall, raised 17" from floor
- Modesty panel offset brackets

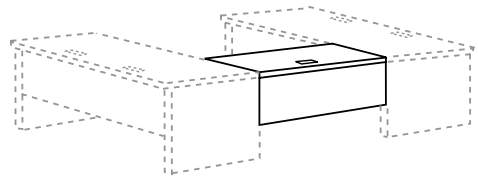

H	D	W	Part #	Metal Color	Lam/ Edge #	Price
29	24	24	BR 2424 P	?	?	\$603
29	24	30	BR 2430 P	?	?	\$632
29	24	36	BR 2436 P	?	?	\$669
29	24	42	BR 2442 P	?	?	\$733
29	24	48	BR 2448 P	?	?	\$749
29	24	60	BR 2460 P	?	?	\$836
29	24	66	BR 2466 P	?	?	\$908
29	24	72	BR 2472 P	?	?	\$937

Bridge – Full Modesty

- One top with grommet (tops 60" or less = 1 center grommet, 66" or more = 2 grommets)
- Four splice plates
- Full height modesty panels are 27-5/8" tall, raised 1/2" from floor
- Modesty panel offset brackets

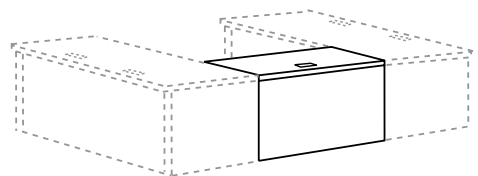

H	D	W	Part #	Metal Color	Lam/ Edge #	Price
29	24	24	BR 2424 F	?	?	\$632
29	24	30	BR 2430 F	?	?	\$662
29	24	36	BR 2436 F	?	?	\$705
29	24	42	BR 2442 F	?	?	\$784
29	24	48	BR 2448 F	?	?	\$807
29	24	60	BR 2460 F	?	?	\$901
29	24	66	BR 2466 F	?	?	\$981
29	24	72	BR 2472 F	?	?	\$1,016

Desk Component Note and Warranty Disclaimer:

Desk components are provided for customer convenience when creating customized desk configurations. It is exclusively the customer's responsibility to select the correct components and component sizes, and to ensure product safety and stability in the application of these components.

Please see the TRACE Desk Assembly Guide (supplied with each order) for proper placement, sequence and tools for connecting support legs, modesty panels, and work surfaces. See the TRACE Freestanding Desk FAQ's for a detailed description of the components listed here.

TRACE Panel Leg (non-handed)

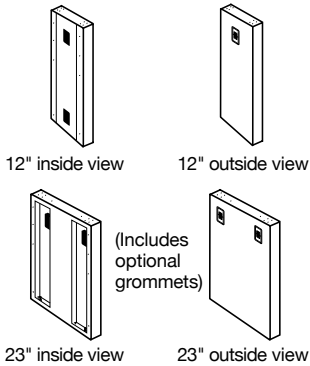

- Each 12" panel leg includes (1) 18" plastic wire management channel, (1) metal wire management cover, and a single centered grommet at the top of the leg
- Each 23" and 29" panel leg includes (1) 18" plastic wire management channel. Metal wire management covers are sold separately (see below)
- Panel legs may be ordered to include two rectangular plastic grommets, positioned at the top of the leg. Add the suffix "G" to include these grommets (no extra charge)
- Leveling glides provide 7/8" adjustment

Description	Pkg Wt	Pkg Cube	Part #	Metal Color	* = No grommet G= grommet	Price
(1) 12" panel leg	11.5 lb	.3 ft	GOL 1201	?	?	\$313
(2) 12" panel leg	25 lb	.8 ft	GOL 1202	?	?	\$626
(1) 23" panel leg	17 lb	.6 ft	GOL 2401	?	?	\$313
(2) 23" panel leg	37 lb	1.5 ft	GOL 2402	?	?	\$626
(1) 29" panel leg	23 lb	1.1 ft	GOL 3001	?	?	\$342
(2) 29" panel leg	46 lb	2.2 ft	GOL 3002	?	?	\$687

TRACE Panel Leg Wire Management Cover

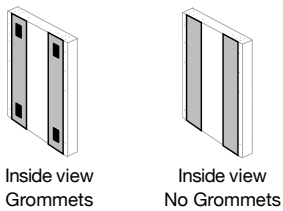

- Provides a finished look for panel leg
- For use on the 23" and 29" panel legs, two covers needed per leg.
- Covers with grommets include two grommets with edge protectors, one each located at top and bottom of each cover
- Specify with or without grommets

Product	Qty	Pkg Wt	Pkg Cube	Part #	Metal Color	Grommets	Price
panel leg cover	pkg. of 2 covers	4 lb	.2 ft	GCV 0002	?	Yes	\$78
	pkg. of 4 covers	8 lb	.2 ft	GCV 0004	?	Yes	\$153
panel leg cover	pkg. of 2 covers	4 lb	.2 ft	GCN 0002	?	No	\$78
	pkg. of 4 covers	8 lb	.2 ft	GCN 0004	?	No	\$153

TRACE Corner Leg

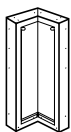

- Each corner leg includes (1) 18" plastic wire management channel. Corner leg wire management cover is sold separately
- Leveling glides provide 7/8" adjustment

Product	Qty	Pkg Wt	Pkg Cube	Part #	Metal Color	Price
corner leg	pkg. of 1 leg	8.7 lb	1.1 ft	GOC 01 K	?	\$231

TRACE Corner Leg Wire Management Cover

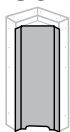

- Attaches magnetically to corner leg

Product	Qty	Pkg Wt	Pkg Cube	Part #	Metal Color	Price
corner leg cover	pkg. of 1 cover	2 lb	.2 ft	GOC 151 K	?	\$68

Panel Leg Gusset



- One gusset is required per 23" or 29" panel leg when no modesty panel or adjacent storage cabinet is present

Product	Qty	Pkg Wt	Pkg Cube	Part #	Metal Color	Price
gussets	pkg. of 1 gusset	1.1 lb	.1 ft	GUS 01 K	?	\$57
	pkg. of 2 gussets	2.2 lb	.2 ft	GUS 02 K	?	\$112

Post Leg

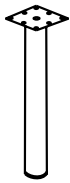

- Post leg is 3" diameter and 27-3/4" high Includes leveling glide
- Pre-drilled to accommodate partial and full-height modesty panels
- Leveling glides provide 7/8" adjustment

Product	Qty	Pkg Wt	Pkg Cube	Part #	Metal Color	Price
post leg (specify color)	pkg. of 1 leg	7 lb	.8 ft	GSK 0036	?	\$251

"H" Leg

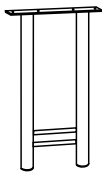

- For use with work surfaces 24" to 30" deep
- H leg is 27-3/4" high, with leveling glides
- Top plate is 6" x 18"
- Leg width is 16"

Product	Qty	Pkg Wt	Pkg Cube	Part #	Metal Color	Price
"h" leg (specify color)	pkg. of 1 leg	15 lb	2.0 ft	GHL 2214	?	\$560

Splice Plate

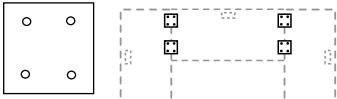

- Connect two work surfaces at 90 degree angles to one another. 4" x 4"

Product	Qty	Pkg Wt	Pkg Cube	Part #	Metal Color	Price
splice plates (black)	pkg. of 2 plates	1.1 lb	.01 ft	GSP 02 K	?	\$46

**Modesty Panel
Offset Bracket**

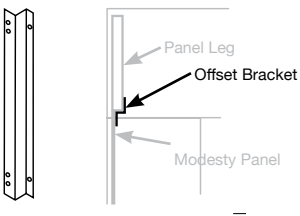

- For use when attaching a modesty panel to the end of a panel leg, as with a return or bridge. Specify bracket for full-height or partial height modesty panel

Product	Qty	Pkg Wt	Pkg Cube	Part #	Metal Color	Price
full-height bracket (specify color)	pkg. of 1 bracket	2 lb	2.0 ft	MPBF 01 K	?	\$61
partial-height bracket (specify color)	pkg. of 1 bracket	2 lb	2.0 ft	MPBH 01 K	?	\$54

**Panel Leg /
Pedestal Bracket**

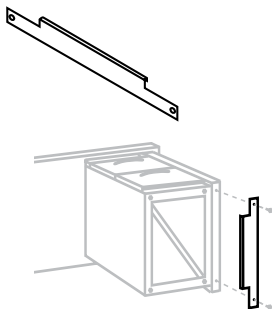

- Securely attaches pedestal to bottom of a panel leg. For use during rugged furniture rearrangement
- Bracket is black

Product	Qty	Pkg Wt	Pkg Cube	Part #	Metal Color	Price
23" panel leg bracket	pkg. of 1 bracket	.5 lb	1.0 ft	PLB 2401 K	?	\$46
23" panel leg bracket	pkg. of 2 brackets	1 lb	1.0 ft	PLB 2402 K	?	\$92
29" panel leg bracket	pkg. of 1 bracket	.8 lb	1.0 ft	PLB 3001 K	?	\$54
29" panel leg bracket	pkg. of 2 brackets	1.6 lb	1.0 ft	PLB 3002 K	?	\$107

Panel leg leveling glides screw through bracket back into panel leg to secure bracket to both pedestal and leg

Modesty Panels

All TRACE modesty panels are single piece 22 gauge metal. Pre-drilled for quick installation with any size panel leg or corner leg. Full height modesty panels are 27-5/8" high, partial height are 12" high. Plan for 1/2" work surface overhang on all sides of legs, modesty panels, and case goods. Panel legs are 1-1/2" thick. Please specify metal color.

Modesty Panel Position	Mod. Width	Pkg Wt	Pkg Cube	Full Height Part #	Metal Color	Full Height Price	Partial Height Part #	Metal Color	Partial Height Price	
Desk Shells Modesty is 4" narrower than work surface width.	30" wide	26"	9 lb	0.7 ft	GKM 2627	?	\$184	GKM 2612 ?	?	\$129
	36" wide	32"	11 lb	0.8 ft	GKM 3227	?	\$198	GKM 3212 ?	?	\$139
	42" wide	38"	13 lb	0.9 ft	GKM 3827	?	\$221	GKM 3812 ?	?	\$145
	48" wide	44"	15 lb	1.1 ft	GKM 4427	?	\$237	GKM 4412 ?	?	\$150
	54" wide	50"	17 lb	1.2 ft	GKM 5027	?	\$251	GKM 5012 ?	?	\$152
	60" wide	56"	20 lb	1.4 ft	GKM 5627	?	\$268	GKM 5612 ?	?	\$161
	66" wide	62"	22 lb	1.5 ft	GKM 6227	?	\$282	GKM 6212 ?	?	\$168
	72" wide	68"	24 lb	1.7 ft	GKM 6827	?	\$297	GKM 6812 ?	?	\$175
Return Shells and Transitional Returns Modesty is 1.5" narrower than work surface width.	30" wide	28.5"	10 lb	0.7 ft	GKM 2827	?	\$190	GKM 2812	?	\$175
	36" wide	34.5"	12 lb	0.9 ft	GKM 3427	?	\$207	GKM 3412	?	\$139
	42" wide	40.5"	14 lb	1.0 ft	GKM 4027	?	\$221	GKM 4012	?	\$145
	48" wide	46.5"	16.5 lb	1.2 ft	GKM 4627	?	\$237	GKM 4612	?	\$150
	60" wide	58.5"	20.5 lb	1.5 ft	GKM 5827	?	\$263	GKM 5812	?	\$161
	66" wide	64.5"	22.5 lb	1.6 ft	GKM 6427	?	\$291	GKM 6412	?	\$168
	72" wide	70.5"	25 lb	1.7 ft	GKM 7027	?	\$306	GKM 7012	?	\$175
"P" Peninsulas Modesty is 20" narrower than works surface width.	60" wide	38"	14 lb	1.0 ft	Full Height Modesty not available		GKM 3812	?	\$145	
	66" wide	44"	16 lb	1.1 ft			GKM 4412	?	\$150	
	72" wide	50"	18 lb	1.3 ft			GKM 5012	?	\$152	
"D" Peninsulas Modesty is 17.5" narrower than work surface width.	60" wide	40.5"	14 lb	1.0 ft	Full Height Modesty not available		GKM 4012	?	\$145	
	66" wide	46.5"	16 lb	1.1 ft			GKM 4612	?	\$150	
	72" wide	52.5"	18 lb	1.3 ft			GKM 5212	?	\$152	
Corners Modesty is 10" narrower than work surface width.	36" wide	26"	18 lb	1.4 ft	GKM 2627	?	\$184	GKM 2612	?	\$129
	42" wide	32"	22 lb	1.6 ft	GKM 3227	?	\$198	GKM 3212	?	\$139
	48" wide	38"	26 lb	1.8 ft	GKM 3827	?	\$221	GKM 3812	?	\$145
Extended Corners Modesty is 10" narrower than work surface width.	48" wide	38"	13 lb	0.9 ft	GKM 3827	?	\$184	GKM 3812	?	\$145
	60" wide	50"	17 lb	1.2 ft	GKM 5027	?	\$198	GKM 5012	?	\$152
	72" wide	62"	22 lb	1.5 ft	GKM 6227	?	\$221	GKM 6212	?	\$168
Bridges Modesty is 1" longer than work surface width.	24" wide	25"	9 lb	0.6 ft	GKM 2527	?	\$182	GKM 2512	?	\$129
	30" wide	31"	11 lb	0.8 ft	GKM 3127	?	\$198	GKM 3112	?	\$133
	36" wide	37"	13 lb	0.9 ft	GKM 3727	?	\$213	GKM 3712	?	\$139
	42" wide	43"	15 lb	1.1 ft	GKM 4327	?	\$232	GKM 4312	?	\$145
	48" wide	49"	16 lb	1.1 ft	GKM 4927	?	\$246	GKM 4912	?	\$152
	54" wide	55"	17 lb	1.2 ft	GKM 5527	?	\$261	GKM 5512	?	\$161
	60" wide	61"	21 lb	1.5 ft	GKM 6127	?	\$277	GKM 6112	?	\$168
	66" wide	67"	23.5 lb	1.7 ft	GKM 6727	?	\$293	GKM 6712	?	\$172
72" wide	73"	25.5 lb	1.8 ft	GKM 7327	?	\$308	GKM 7312	?	\$175	
3/4 Pedestal Desks Modesty panels are all 20" high, and 4" narrower than the work surface width.	60" wide	56"	One height only, to match hanging pedestal height: 19-3/8"				GKM 5620	?	\$268	
	66" wide	62"					GKM 6220	?	\$282	
	72" wide	68"					GKM 6820	?	\$297	

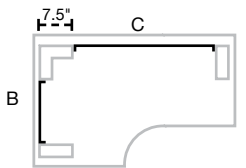
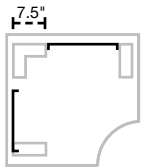
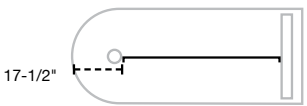
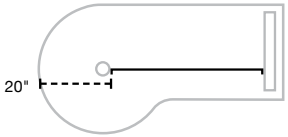
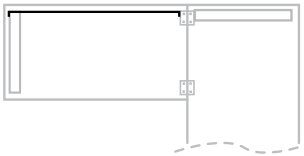

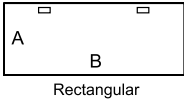

Work Surface Shape	A	B	C	D	Pkg Wt	Pkg Cube	Part #	Lam/Edge #	Price
Rectangular	23.5	48.0	(ped tower work surface)		39.5 lb	0.8 ft	WS 2348	?	\$558
	23.5	60.0	(ped tower work surface)		49.4 lb	1.0 ft	WS 2360	?	\$622
	24.0	24.0			20.2 lb	0.4 ft	WS 2424 G	?	\$435
	24.0	30.0			25.2 lb	0.5 ft	WS 2430 G	?	\$440
	24.0	36.0			30.2 lb	0.6 ft	WS 2436 G	?	\$475
	24.0	42.0			35.3 lb	0.7 ft	WS 2442 G	?	\$538
	24.0	48.0			40.3 lb	0.8 ft	WS 2448 G	?	\$543
	24.0	54.0			45.4 lb	0.9 ft	WS 2454 G	?	\$605
	24.0	60.0			50.4 lb	1.0 ft	WS 2460 G	?	\$612
	24.0	66.0			55.4 lb	1.2 ft	WS 2466 LR	?	\$650
	24.0	72.0			60.5 lb	1.3 ft	WS 2472 LR	?	\$694
	30.0	30.0			31.5 lb	0.7 ft	WS 3030 G	?	\$485
	30.0	36.0			37.8 lb	0.8 ft	WS 3036 G	?	\$526
	30.0	42.0			44.1 lb	0.9 ft	WS 3042 G	?	\$602
	30.0	48.0			50.4 lb	1.0 ft	WS 3048 G	?	\$609
	30.0	54.0			56.7 lb	1.2 ft	WS 3054 G	?	\$685
	30.0	60.0			63 lb	1.3 ft	WS 3060 G	?	\$691
	30.0	66.0			69.3 lb	1.4 ft	WS 3066 LR	?	\$757
	30.0	72.0			75.6 lb	1.5 ft	WS 3072 LR	?	\$764
	36.0	48.0			60.5 lb	1.3 ft	WS 3648 G	?	\$761
36.0	60.0			67.3 lb	1.5 ft	WS 3660 G	?	\$823	
36.0	66.0			83.2 lb	1.7 ft	WS 3666 LR	?	\$837	
36.0	72.0			90.7 lb	1.9 ft	WS 3672 LR	?	\$858	
Bow Rectangular	30.0	72.0	36.0		90.7 lb	1.9 ft	WSB 3672 LR	?	\$1,037
Curved Corner	24.0	36.0			30.2 lb	0.6 ft	WRCR 3636	?	\$648
	24.0	42.0			35.3 lb	0.7 ft	WRCR 4242	?	\$863
	24.0	48.0			40.3 lb	0.8 ft	WRCR 4848	?	\$881
Straight Corner	24.0	36.0			30.2 lb	0.6 ft	WCR 3636	?	\$650
	24.0	42.0			35.3 lb	0.7 ft	WCR 4242	?	\$865
	24.0	48.0			40.3 lb	0.8 ft	WCR 4848	?	\$879
Extended Corner Left	24.0	48.0	60.0	24.0	76 lb	2.1 ft	EC 23602 L	?	\$1,306
	24.0	48.0	72.0	24.0	86 lb	2.5 ft	EC 23722 L	?	\$1,483
	24.0	48.0	60.0	30.0	83 lb	2.1 ft	EC 23603 L	?	\$1,306
	24.0	48.0	72.0	30.0	96 lb	2.5 ft	EC 23723 L	?	\$1,483
	30.0	48.0	60.0	24.0	81 lb	2.1 ft	EC 33602 L	?	\$1,306
	30.0	48.0	72.0	24.0	87 lb	2.1 ft	EC 33722 L	?	\$1,483
	30.0	48.0	60.0	30.0	91 lb	2.5 ft	EC 33603 L	?	\$1,306
	30.0	48.0	72.0	30.0	100 lb	2.5 ft	EC 33723 L	?	\$1,483
Extended Corner Right	24.0	48.0	60.0	24.0	76 lb	2.1 ft	EC 23602 R	?	\$1,306
	24.0	48.0	72.0	24.0	86 lb	2.5 ft	EC 23722 R	?	\$1,483
	24.0	48.0	60.0	30.0	83 lb	2.1 ft	EC 23603 R	?	\$1,306
	24.0	48.0	72.0	30.0	96 lb	2.5 ft	EC 23723 R	?	\$1,483
	30.0	48.0	60.0	24.0	81 lb	2.1 ft	EC 33602 R	?	\$1,306
	30.0	48.0	72.0	24.0	87 lb	2.1 ft	EC 33722 R	?	\$1,483
	30.0	48.0	60.0	30.0	91 lb	2.5 ft	EC 33603 R	?	\$1,306
	30.0	48.0	72.0	30.0	100 lb	2.5 ft	EC 33723 R	?	\$1,483
"D" Shaped Peninsula	23.5	48.0			39.5 lb	0.8 ft	WP 2348 LR	?	\$671
	23.5	60.0			49.4 lb	1.0 ft	WP 2360 LR	?	\$757
	30.0	60.0			63 lb	1.3 ft	WP 3060 LR	?	\$875
	30.0	66.0			69.3 lb	1.4 ft	WP 3066 LR	?	\$967
"P" Shaped Peninsula Left	30.0	72.0			75.6 lb	1.6 ft	WP 3072 LR	?	\$979
	30.0	60.0	36.0		73.5 lb	1.6 ft	WPL 3060 LR	?	\$1,191
	30.0	66.0	36.0		79 lb	1.7 ft	WPL 3066 LR	?	\$1,327
	30.0	72.0	36.0		85 lb	1.9 ft	WPL 3072 LR	?	\$1,341
"P" Shaped Peninsula Right	30.0	60.0	36.0		73.5 lb	1.6 ft	WPR 3060 LR	?	\$1,191
	30.0	66.0	36.0		79 lb	1.7 ft	WPR 3066 LR	?	\$1,327
	30.0	72.0	36.0		85 lb	1.9 ft	WPR 3072 LR	?	\$1,341
	30.0	72.0	36.0		85 lb	1.9 ft	WPR 3072 LR	?	\$1,341

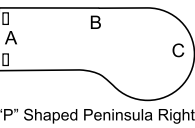
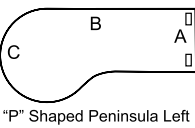
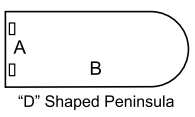
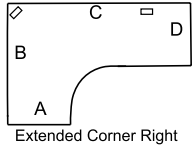
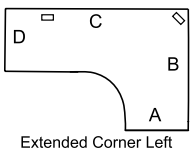
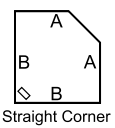
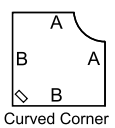
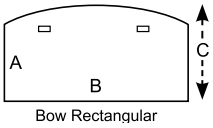

KD Desk Hutch

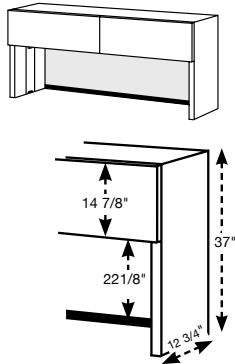

- Doors flip up to stow over the top, hutch compartment includes a vertical center divider
- 36" and 42" wide hutches include one door, all others include two doors
- Inside depth is 12-1/2" and inside height is 12-1/4"
- Out-of-sight locks are located beneath shelf, and the two doors are keyed alike
- Includes UM series locks - also available in LL. SL locks are not available
- Includes tack board and rubber wire management strip
- Bottom shelf accommodates a task light (sold separately)
- To add a loop pull (S: Satin Nickel Loop) to hutch doors, add an "L" as a suffix to the product number (no up-charge)
- Removable metal wire management covers on hutch side panels conceal task light cord
- Hutch upright side panels must be placed within 2" of a pedestal, panel leg, or corner leg to ensure adequate support
- Hutch width is actually 1" narrower than listed, to allow for 1/2" setback on both sides
- Hutch ships knocked down with assembly instructions for field installation
- Specify metal color and fabric
- For yardage requirements see "Ordering COM Fabrics" in this price book

H	D	W	Pkg Wt	Pkg Cube	Part #	Metal Color	Fabric #	GR 1 Price	GR 2 Price	GR 3 Price	GR 4 Price	GR 5 Price	COM Price
37	13-5/8	36	60 lb	13.3 ft	HGC 3602	?	?	\$2,041	\$2,148	\$2,224	\$2,301	\$2,364	\$1,940
37	13-5/8	42	66 lb	15.4 ft	HGC 4202	?	?	\$2,190	\$2,192	\$2,269	\$2,346	\$2,409	\$1,986
37	13-5/8	48	75 lb	17.5 ft	HGC 4802	?	?	\$2,235	\$2,236	\$2,312	\$2,389	\$2,451	\$2,028
37	13-5/8	54	81 lb	19.6 ft	HGC 5402	?	?	\$2,290	\$2,347	\$2,450	\$2,552	\$2,635	\$2,075
37	13-5/8	60	87 lb	21.7 ft	HGC 6002	?	?	\$2,337	\$2,390	\$2,494	\$2,596	\$2,679	\$2,119
37	13-5/8	66	93 lb	23.8 ft	HGC 6602	?	?	\$2,384	\$2,433	\$2,536	\$2,638	\$2,722	\$2,161
37	13-5/8	72	99 lb	25.9 ft	HGC 7202	?	?	\$2,452	\$2,561	\$2,689	\$2,817	\$2,921	\$2,224

LED Linear Task Light

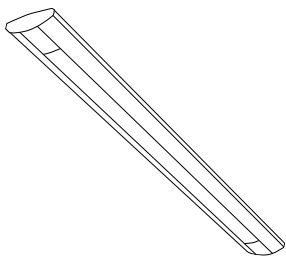

- 9' black power cord
- 3500K color temperature
- Metal trough reflector with diffuser lens
- Magnetic or screw mounting options
- Clear anodized aluminum with flint color end caps, UL/CUL listed
- 5 year warranty

LED Green Advantages:

- Solid state technology eliminates the need for Chicago Code (fused plugs)
- Low energy consumption, No UV emissions, no flickering
- No disposal hazards - no mercury, lead, or gases
- Long life @ 50,000 hours eliminating re-lamp and maintenance time
- Allows for low profile, light weight, fixture designs

For Use on	H	D	W	LEDs	Pkg Wt	Pkg Cube	Part #	Price
24" to 36" shelves	1/2	2	16-1/2	24	4 lb	2 ft	LD 618	\$511
42" to 72" shelves	1/2	2	30-1/8	48	10 lb	3 ft	LD 1236	\$824

Fluorescent Task Light



- Task light snaps in place beneath the hutch shelf with spring clips
- A 3-1/2" wide lens opening provides maximum light output
- T8 Tri-phosphor 3500K fluorescent lamp
- Includes a 9' black SJT cord
- UL and CUL listed

For Use on	H	D	W	Pkg Wt	Pkg Cube	Part #	Price
36" hutch	1-1/2	6-7/8	18-1/3	6 lb	3.1 ft	VT 18-B K	\$291
42", 48", 54" hutch	1-1/2	6-7/8	36-1/3	12 lb	6.8 ft	VT 36-B K	\$351
60", 66", 72" hutch	1-1/2	6-7/8	48-1/3	18 lb	9.1 ft	VT 48-B K	\$390

Personal Drawer

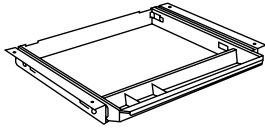

- Sleek, metal design allows the drawer to hide discretely beneath the desk
- Full extension steel ball-bearing slides
- Four integral storage compartments
- Mounts to underside of work surface using "L" brackets affixed to drawer slides
- Drawer and mounting brackets are 22 gauge steel
- Charcoal powder coat finish
- Available with or without a lock
- Lock may also be ordered separately for field installation, and add 1-1/2" width to the drawer size

Description	H	D	W	Pkg Wt	Pkg Cube	Part #	Price
drawer with lock	2-1/8	17-1/4	21-3/4	13 lb	1 ft	NFC7657889-UM	\$327
drawer only	2-1/8	17-1/4	21-3/4	13 lb	1 ft	NFC7657889	\$227
lock only	2-1/8	1-1/2	1-1/2	1 lb	.5 ft	NFCX00020	\$99

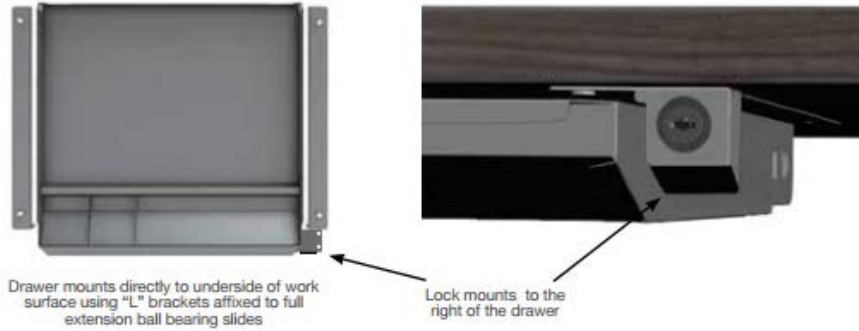

**Acrylic
Privacy Screens**

- Frosted acrylic screens are 1/4" thick
- Screens 54" and smaller include two aluminum brackets
- Screens 60" and wider include three aluminum brackets
- These brackets may be paired with modesty panel brackets shown below
- Top of Acrylic privacy screen to floor measures 41-1/2"

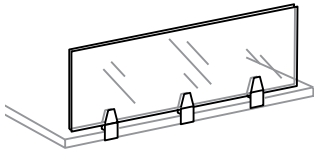

H	W	Description	Pkg Wt	Pkg Cube	Part #	Price
12-1/2	23	24" acrylic privacy screen	3.5 lb	0.7 ft	ACR 1124 F	\$226
12-1/2	29	30" acrylic privacy screen	4.25 lb	0.9 ft	ACR 1130 F	\$260
12-1/2	35	36" acrylic privacy screen	5.0 lb	1.08 ft	ACR 1136 F	\$287
12-1/2	41	42" acrylic privacy screen	5.75 lb	1.26 ft	ACR 1142 F	\$307
12-1/2	47	48" acrylic privacy screen	6.25 lb	1.44 ft	ACR 1148 F	\$330
12-1/2	53	54" acrylic privacy screen	7.0 lb	1.63 ft	ACR 1154 F	\$509
12-1/2	59	60" acrylic privacy screen	7.75 lb	1.81 ft	ACR 1160 F	\$538
12-1/2	65	66" acrylic privacy screen	8.75 lb	1.99 ft	ACR 1166 F	\$543
12-1/2	71	72" acrylic privacy screen	9.59 lb	2.17 ft	ACR 1172 F	\$546

**Acrylic
Modesty Panels**

- Frosted acrylic screens are 1/4" thick
- Panel widths are designed to be 12" narrower than the work surface (6" inset on each side)
- Screens 54" and smaller include two aluminum brackets
- Screens 60" and wider include three aluminum brackets
- These brackets may be paired with privacy screen brackets shown above

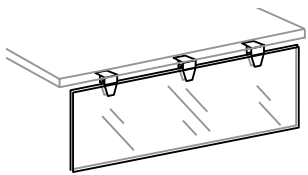

H	W	Description	Pkg Wt	Pkg Cube	Part #	Price
12-1/2	29	30" acrylic modesty panel	4.25 lb	0.9 ft	ACR 1130	\$255
12-1/2	35	36" acrylic modesty panel	5.0 lb	1.08 ft	ACR 1136	\$282
12-1/2	41	42" acrylic modesty panel	5.75 lb	1.26 ft	ACR 1142	\$302
12-1/2	47	48" acrylic modesty panel	6.25 LB	1.44 ft	ACR 1148	\$326
12-1/2	53	54" acrylic modesty panel	7.0 lb	1.63 ft	ACR 1154	\$503
12-1/2	59	60" acrylic modesty panel	7.75 lb	1.81 ft	ACR 1160	\$531
12-1/2	65	66" acrylic modesty panel	8.75 lb	1.99 ft	ACR 1166	\$535
12-1/2	71	72" acrylic modesty panel	9.59 lb	2.17 ft	ACR 1172	\$539

**Brackets Sold
Separately**

Our brushed aluminum clips are also sold separately to be used with customer-supplied privacy screen or modesty panel material. (1/4" thickness required for modesty panel and 1-1/4" thickness for worksurface.)

Description	Part #	Price
Two complete clip assemblies to support both above-surface screen and below-surface modesty panel. Includes mounting hardware and instruction sheets	ACM 02K	\$157
Three complete clip assemblies to support both above-surface privacy screen and below-surface modesty panel. Includes mounting hardware and instruction sheets	ACM 03K	\$213

Bracket Detail:

Modesty panel bracket, as shown \$80. Sold in units of (1) MSC0025
Privacy screen bracket, as shown \$90. Sold in units of (1) PSC0010

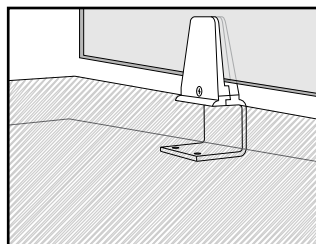

Privacy Screen Bracket
Attaches underneath work surface
with fasteners (included)

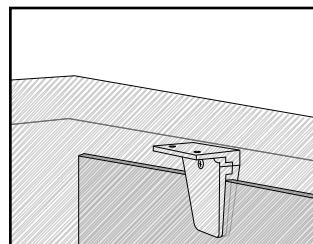

Modesty Panel Bracket
Attaches underneath work surface
with fasteners (included)

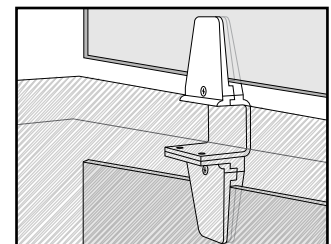

Privacy Screen and Modesty Panel
brackets may be used together

**Metal
Modesty Panels
- Solid**

- These metal modesty panels are solid; they do not include perforations
- Wire management tray at bottom is 2" deep
- Panels are 20 gauge
- Panels attach underneath the work surface with 3/4" fasteners (included)
- Panels are designed to be in-set 6" from each side of the work surface

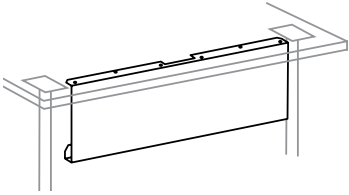

H	D	W	Description	Pkg Wt	Pkg Cube	Part #	Metal Color	Price
11	2	18	18" panel for 30" WS	3.25 lb	0.38 ft	MOD 1811	?	\$174
11	2	24	24" panel for 36" WS	4.25 lb	0.50 ft	MOD 2411	?	\$185
11	2	30	30" panel for 42" WS	5.25 lb	0.61 ft	MOD 3011	?	\$196
11	2	36	36" panel for 48" WS	6.25 lb	0.73 ft	MOD 3611	?	\$206
11	2	42	42" panel for 54" WS	6.75 lb	0.84 ft	MOD 4211	?	\$217
11	2	48	48" panel for 60" WS	8.12 lb	0.95 ft	MOD 4811	?	\$228
11	2	54	54" panel for 66" WS	9.25 lb	1.07 ft	MOD 5411	?	\$240
11	2	60	60" panel for 72" WS	9.75 lb	1.18 ft	MOD 6011	?	\$251

**Metal
Modesty Panels
- Perforated**

- Perforated metal modesty panel
- Perforations are 1/2" in diameter
- Wire management tray at bottom is 2" deep
- Panels are 20 gauge
- Panels attach underneath the work surface with 3/4" fasteners (included)
- Panels are designed to be in-set 6" from each side of the work surface

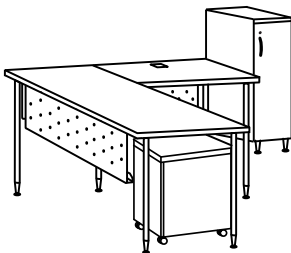
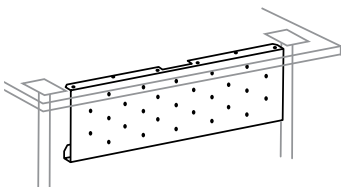

H	D	W	Description	Pkg Wt	Pkg Cube	Part #	Metal Color	Price
11	2	18	18" panel for 30" WS	3.25 lb	0.38 ft	MOD 1811 P	?	\$185
11	2	24	24" panel for 36" WS	4.25 lb	0.50 ft	MOD 2411 P	?	\$196
11	2	30	30" panel for 42" WS	5.25 lb	0.61 ft	MOD 3011 P	?	\$206
11	2	36	36" panel for 48" WS	6.25 lb	0.73 ft	MOD 3611 P	?	\$217
11	2	42	42" panel for 54" WS	6.75 lb	0.84 ft	MOD 4211 P	?	\$228
11	2	48	48" panel for 60" WS	8.12 lb	0.95 ft	MOD 4811 P	?	\$240
11	2	54	54" panel for 66" WS	9.25 lb	1.07 ft	MOD 5411 P	?	\$251
11	2	60	60" panel for 72" WS	9.75 lb	1.18 ft	MOD 6011 P	?	\$262

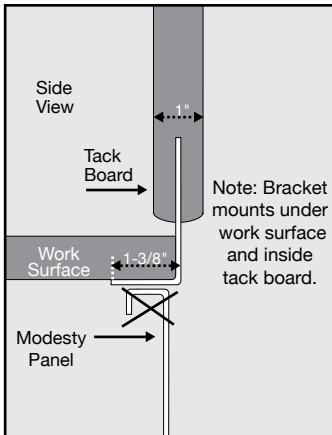

Cannot be used with modesty panels.

- Tackable board is covered on both sides with fabric of your choice. Brackets and fasteners are included, which allow the screen to be fastened to the underside of the work surface
- 12 gauge metal mounting brackets slide between these back-to-back tackable boards and are hidden from sight (See cut-away diagram below)
- Please note that tackable privacy screens may not be added to a desk when modesty panels are in use because the screen mounting brackets interfere with the modesty panel location
- Screens 35" and narrower include two mounting brackets
- Screens 41" and wider include three mounting brackets
- Privacy screen widths may be matched to that of the corresponding work surface size
- Screens measure one inch less than the work surface widths to allow for even spacing between screens, wire management, and cornering applications
- For yardage requirements see "Ordering COM Fabrics" in this price book on page 10

Tackable Screen – Rectangular

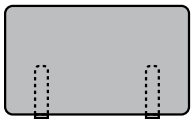

Dotted lines indicate hidden mounting brackets

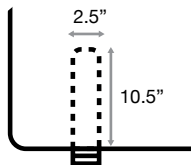

H	D	W	Pkg Wt	Pkg Cube	Part #	Fabric #	GR 1 Price	GR 2 Price	GR 3 Price	GR 4 Price	GR 5 Price	COM Price
20-3/4	1	23	9 lb	.6 ft	PSR 24	?	\$505	\$635	\$687	\$740	\$783	\$500
20-3/4	1	29	10 lb	.8 ft	PSR 30	?	\$568	\$697	\$750	\$803	\$844	\$563
20-3/4	1	35	11 lb	.9 ft	PSR 36	?	\$625	\$820	\$898	\$976	\$1,039	\$620
20-3/4	1	41	13 lb	1.0 ft	PSR 42	?	\$680	\$875	\$953	\$1,031	\$1,094	\$675
20-3/4	1	47	14 lb	1.2 ft	PSR 48	?	\$719	\$914	\$992	\$1,070	\$1,134	\$714
20-3/4	1	59	17 lb	1.5 ft	PSR 60	?	\$896	\$1,221	\$1,351	\$1,481	\$1,587	\$891
20-3/4	1	65	18 lb	1.6 ft	PSR 66	?	\$943	\$1,269	\$1,398	\$1,528	\$1,634	\$938
20-3/4	1	71	19 lb	1.8 ft	PSR 72	?	\$1,027	\$1,353	\$1,482	\$1,613	\$1,718	\$1,022

H	D	W	Pkg Wt	Pkg Cube	Part #	Fabric #	GR 1 Price	GR 2 Price	GR 3 Price	GR 4 Price	GR 5 Price	COM Price
11	1	23	7 lb	.6 ft	SPR 24	?	\$443	\$571	\$624	\$676	\$719	\$438
11	1	29	8 lb	.8 ft	SPR 30	?	\$484	\$613	\$666	\$718	\$760	\$479
11	1	35	9 lb	.9 ft	SPR 36	?	\$531	\$726	\$804	\$882	\$945	\$526
11	1	41	11 lb	1.0 ft	SPR 42	?	\$579	\$773	\$852	\$930	\$993	\$574
11	1	47	12 lb	1.2 ft	SPR 48	?	\$611	\$806	\$884	\$962	\$1,025	\$606
11	1	59	14 lb	1.5 ft	SPR 60	?	\$762	\$1,088	\$1,217	\$1,347	\$1,453	\$757
11	1	65	16 lb	1.6 ft	SPR 66	?	\$800	\$1,126	\$1,255	\$1,385	\$1,491	\$795
11	1	71	19 lb	1.8 ft	SPR 72	?	\$872	\$1,197	\$1,327	\$1,457	\$1,562	\$867

Tackable Screen – Scalloped

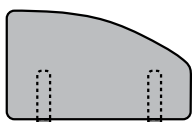

Hidden mounting brackets

- Scalloped-shaped screen provides a "finished" look for desks positioned at the end of a run
- Available for use with 20-3/4" high rectangular screens only
- See page 10 for yardage requirements

H	D	W	Pkg Wt	Pkg Cube	Part #	Fabric #	GR 1 Price	GR 2 Price	GR 3 Price	GR 4 Price	GR 5 Price	COM Price
20-3/4	1	29	10 lb	.8 ft	SPSR 30	?	\$622	\$751	\$804	\$856	\$898	\$617
20-3/4	1	35	11 lb	.8 ft	SPSR 36	?	\$672	\$867	\$945	\$1,023	\$1,087	\$667

Modular Electrical Components

How to order:

- Determine the configurations that need power and electrical load requirements.
- Choose Base Feed. **
- Establish placement of Power Blocks.
- Identify # and style of Receptacles per power block.
- Determine connecting cable lengths by taking center to center distance between power blocks, adding any additional cable required to pass under or around object. Subtract 8" and use the next largest size cable unless measurement is exact.

For Example:

Sample #1 the power blocks are centered in the 42" returns, so half the return size is 21" for each return (21" + 21") plus 30" depth of the peninsula, minus 8".

$$(21" + 21" + 30" - 8" = 64" \text{ connector length})$$

- Determine needed accessories.

Description	Part #	Price
6' Base Feed	84SB272	\$258
12' Base Feed (Extra Long)	84SB2144	\$410
Power Block*	844AA/78MB	\$125
Receptacle 1	84S1BL150	\$23
Receptacle 2	84S2BL150	\$23
Receptacle 4	84S4BL150	\$23
Isolated Receptacle 3***	84SIGOR150	\$26
Receptacle Removal Tool	8SR	\$11

* Mounting bracket included

** Base feed required

*** Isolated Receptacles are to protect electronic equipment from electromagnetic noise

Note: In some configurations, the power block will not be centered.

Description	Part #	Price
Connector 16"	84FF16	\$167
Connector 22"	84FF22	\$180
Connector 28"	84FF28	\$192
Connector 34"	84FF34	\$205
Connector 40"	84FF40	\$216
Connector 46"	84FF46	\$230
Connector 52"	84FF52	\$243
Connector 58"	84FF58	\$255
Connector 64"	84FF64	\$267
Connector 70"	84FF70	\$280
Connector 76"	84FF76	\$293
Connector 82"	84FF82	\$306
Connector 88"	84FF88	\$318
Connector 94"	84FF94	\$331

Base Feed



84SB272 - 6 foot length
84SB2144 - 12 foot length

Note: 8 Wire, 4 Circuit System:
Must be hard wired by a Licensed Electrician

Power Blocks & Receptacles

Power Block 844AA/78MB*
(2) 84S1BL150, 84S2BL150, 84S4BL150

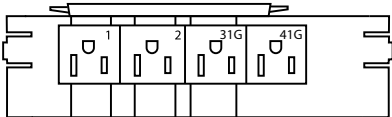

Power Block is two sided Power block does not include the receptacles shown

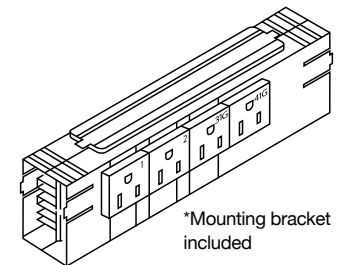

*Mounting bracket included

Connecting Cables

Available Lengths - 16" to 95"



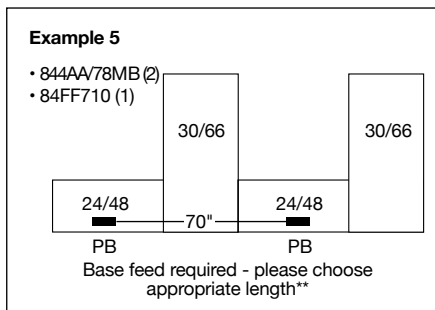
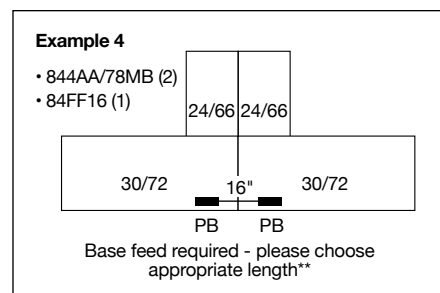
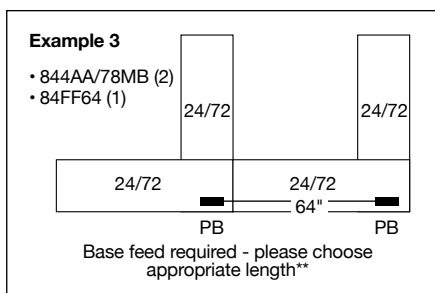
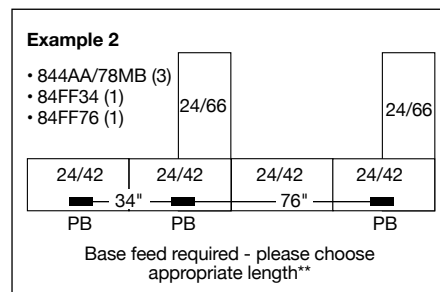
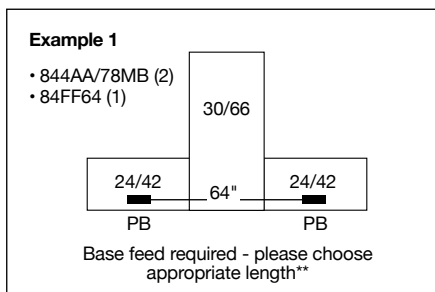

**Cove - Table Top
Solutions**

- Flush-mount data, power & USB charging
- Versatile power & charging solution designed to integrate power, USB charging ports & data capabilities into a variety of spaces

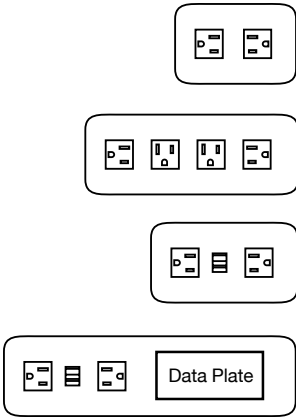

Description	Color	Pkg Wt	Pkg Cube	Part #	Price
(2) Power	white	3 lb	.07 ft	COV2 108 W	\$507
(2) Power	silver	3 lb	.07 ft	COV2 108 S	\$507
(2) Power	black	3 lb	.07 ft	COV2 108 B	\$507
(4) Power	white	5 lb	.11 ft	COV4 108 W	\$876
(4) Power	silver	5 lb	.11 ft	COV4 108 S	\$876
(4) Power	black	5 lb	.11 ft	COV4 108 B	\$876
(2) Power (2) USB	white	3.5 lb	.07 ft	COV2U 108 W	\$758
(2) Power (2) USB	silver	3.5 lb	.07 ft	COV2U 108 S	\$758
(2) Power (2) USB	black	3.5 lb	.07 ft	COV2U 108 B	\$758
(2) Power (2) USB Data Plate Cut-out*	white	5.25 lb	.11 ft	COV2UD 108 W	\$758
(2) Power (2) USB Data Plate Cut-out*	silver	5.25 lb	.11 ft	COV2UD 108 S	\$758
(2) Power (2) USB Data Plate Cut-out*	black	5.25 lb	.11 ft	COV2UD 108 B	\$758

Data Plate

- Data plates allow you to harness the data & AV capabilities of your table top solutions
- Additional configurations available. Contact Sales for a quote.

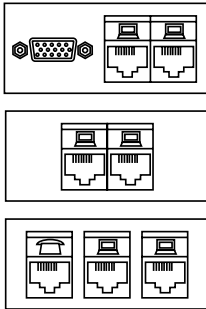

Description	Pkg Wt	Pkg Cube	Part #	Price
(2) RJ 45 (1) 15 pin VGA	0.5 lb	.2 ft	A BL B B C51	\$402
(2) RJ 45	0.5 lb	.2 ft	A BL B B	\$222
(1) RJ11 (2) RJ 45	0.5 lb	.2 ft	A BL A B B	\$281

**Work Surface
Splice Plate**

- Connect two work surfaces at 90 degree angles to one another.
- Plate dimensions: 4" x 4"

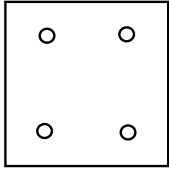

Description	Qty	Pkg Wt	Pkg Cube	Part #	Price
splice plates (black)	pkg. of 2 plates	1.1 lb	.01 ft	GSP 02 K	\$46



**Work Surface
Grommet
Field Installed**

- Package of ten 2-1/2" diameter round black plastic grommets for field installation
- Circular shape allows for easy installation at the work site

Description	Pkg Wt	Pkg Cube	Part #	Price
(10) round grommets	4 lb	.6 ft	GRM 0010	\$104

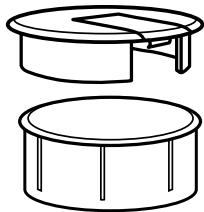

**Plastic Wire
Management
Channel**

- Black plastic wire organizer channels hide tangled wires and cables. Self-adhesive backing mounts horizontally or vertically on modesty panels, end panel legs, pedestals or underside of work surfaces
- Kit includes 4 channels that are 18" long x 2-1/2" wide x 1-1/4" tall. Channels may be cut to desired length

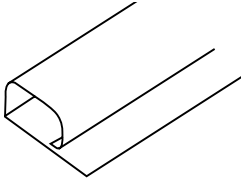

Description	Pkg Wt	Pkg Cube	Part #	Price
(4) 18" channels	6 lb	3 ft	WMG 4018	\$63

Wire Tray

- Includes (1) 35" channel, (15) hooks, (2) end-caps, and fasteners
- Fits behind modesty panels
- End-caps screw to bottom of work surface and secure wire tray

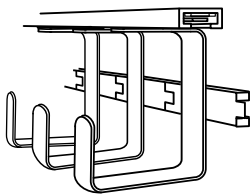

H	D	W	Description	Pkg Wt	Pkg Cube	Part #	Price
3-7/16	2-11/16	35	35" under desk wire tray	2 lb	.5 ft	WIR3515	\$165

Corner Wedge

- Used in 90° desk applications to add more user desk space
- Includes two splice plates and fasteners for securing to work surface
- Center drawers cannot be mounted underneath because of splice plate placement
- Specify laminate and edge band

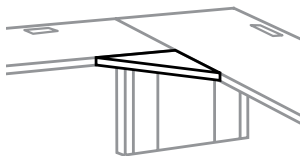
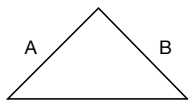

Description	A	B	Pkg Wt	Pkg Cube	Part #	Lam/Edge #	Price
corner wedge	12"	12"	5 lb	1 ft	W1212	?	\$322

Pete



- Translucent solid resin top is 1" thick with a soft profiled edge and a slightly textured finish on all sides and edges.
- Trumpet table base is 16 gauge spun steel with a powder coat finish. Weldment consist of a star top plate, and a spun steel weighted base. The table base is attached to the resin table top by means of a precisionally machined, powder coated decorative insert and a 1/4-20 satin nickel, decorative head machine screw
- 1-3/8" diameter black nylon leveling glides with a stainless steel stem
- Light assembly required

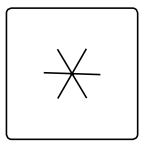
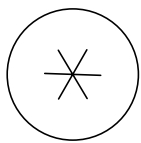

H	Diameter	Top	Part #	Metal #	Price
16	17	Circular	PETE-C-1716-TT	?	\$1,634
		Circular w/USB	PETE-C-USB-1716-TT		\$1,876
23	29	Circular	PETE-C-2923-TT	?	\$2,768
		Circular w/USB	PETE-C-USB-2923-TT		\$3,010
29	29	Circular	PETE-C-2929-TT	?	\$2,768
		Circular w/USB	PETE-C-USB-2929-TT		\$3,010
29	35	Circular	PETE-C-3529-TT	?	\$3,545
		Circular w/USB	PETE-C-USB-3529-TT		\$3,787
40	35	Circular	PETE-C-3540-TT	?	\$3,608
		Circular w/USB	PETE-C-USB-3540-TT		\$3,850
29	41	Circular	PETE-C-4129-TT	?	\$3,655
		Circular w/USB	PETE-C-USB-4129-TT		\$3,897
29	47	Circular	PETE-C-4729-TT	?	\$3,782
		Circular w/USB	PETE-C-USB-4729-TT		\$4,024
29	29	Square	PETE-S-2929-TT	?	\$2,768
		Square w/USB	PETE-S-USB-2929-TT		\$3,010
29	35	Square	PETE-S-3529-TT	?	\$3,545
		Square w/USB	PETE-S-USB-3529-TT		\$3,787
29	41	Square	PETE-S-4129-TT	?	\$3,655
		Square w/USB	PETE-S-USB-4129-TT		\$3,897

Cupcake



- The seat frame is constructed of one horizontal panel fabricated from upholstery grade, 15/16" thick, 7-ply fir plywood.
- Cushion top panel is 3 inch thick, fire retardant polyurethane foam of 2.8 lb density and 80 lb IFD. The vertical outside surfaces are 1/4" thick, fire retardant polyurethane foam of 1.6 lb density and 55 lb IFD at 25% deflection
- Meets California Technical Bulletin 117 for flammability. Class A fire rated in accordance with Commercial Standard CS-191-53.
- Fully upholstered unit is in accordance with BIFMA F-1-1978 (Rev. A80), First Generation Voluntary Upholstered Furniture Flammability Standard for Business and Institution Markets
- Trumpet stool base is 16 gauge spun steel with a powder coat finish. Weldment consists of a vented top plate and a spun steel weighted base. The stool base is attached to the cushion assembly by means of a 1/4-20 satin nickel, decorative head machine screw and a 1/4-20 nonvisible propeller nut. The underside of the base is Teflon coated to produce a non-abrasive, easy-slide surface
- Yardage Requirements: 1 yard, based on 54" wide plain fabric. Please contact customer service for fabrics with repeats or different widths to determine yardage requirements

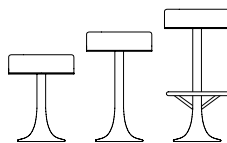

FABRIC

- COM Customer Supplied
- GR1 Grade 1
- GR2 Grade 2
- GR3 Grade 3
- GR4 Grade 4
- GR5 Grade 5

H	Diameter	Part #	Metal #	Fabric #	GR 1 Price	GR 2 Price	GR 3 Price	GR 4 Price	GR 5 Price	GR 6 Price	COM Price
19	15	CUPCAKE-SIDE	?	?	\$1,500	\$1,558	\$1,587	\$1,645	\$1,703	\$1,762	\$1,419
24	15	CUPCAKE-CTR	?	?	\$1,677	\$1,735	\$1,763	\$1,822	\$1,880	\$1,938	\$1,595
29	15	CUPCAKE-BAR	?	?	\$2,048	\$2,106	\$2,135	\$2,193	\$2,251	\$2,309	\$1,966

Sly



- Metal base available in any Great Openings color, or your choice of custom color
- Tapered, curved design
- Body-conforming profile
- Four standard laminate options
- Two heights: stackable side chair and bar stool

WILSONART LAMINATE OPTIONS

BL Black 1595-07
GM Grey Mesh 4877-38
WC Wild Cherry 7054-60
KM Kensington Maple 10776-60

Back Height	Seat Height	D	W	Part #	Laminate #	Metal #	Price
32.75	18.50	22	18.50	SLY-SIDE	?	?	\$724
32.25	30.25	22	18.50	SLY-BAR STOOL	?	?	\$904

Manny

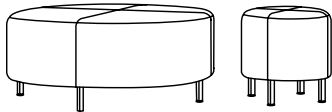

YARDAGE REQUIREMENTS

MAN-19R 2 yards
MAN-27R 3 yards
MAN-45R 5 yards

- Legs are 3" round nickel welded to an 11 gauge top plate
- 1-3/8" diameter black nylon leveling glides with a stainless steel stem
- Trim is 11 gauge steel fastened proud to underside of the case
- Available with and without power. ONE AXL-Z UNIT INCLUDED WITH POWER OPTION - default position is right hand seated side
- Manny overstitch thread color is gray
- Fabric yardage requirements are based on 54" wide plain fabric. Please contact customer service for fabrics with repeats or different widths to determine yardage requirements
- Upholstery is a tight, weltless design with over stitching creating a quartered appearance
- Foam meets California Technical Bulletin 117 for flammability
- Ships fully assembled

H	Dia	Part #	Power	Fabric #	GR 1 Price	GR 2 Price	GR 3 Price	GR 4 Price	GR 5 Price	COM Price
19	19	MAN-19R	-	?	\$1,868	\$1,981	\$2,038	\$2,151	\$2,264	\$1,708
19	27	MAN-27R	-	?	\$2,251	\$2,419	\$2,504	\$2,674	\$2,844	\$2,011
		MAN-27R	EL	?	\$2,956	\$3,124	\$3,209	\$3,379	\$3,549	\$2,716
19	45	MAN-45R	-	?	\$2,796	\$3,079	\$3,220	\$3,503	\$3,786	\$2,399
		MAN-45R	EL	?	\$3,501	\$3,784	\$3,925	\$4,208	\$4,491	\$3,104

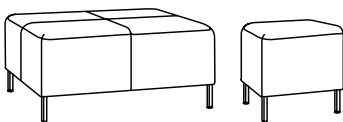

YARDAGE REQUIREMENTS

MAN-19 2 yards
MAN-32 5 yards
MAN-44 6 yards

H	D	W	Part #	Power	Fabric #	GR 1 Price	GR 2 Price	GR 3 Price	GR 4 Price	GR 5 Price	COM Price
19	19	19	MAN-19	-	?	\$1,757	\$1,870	\$1,926	\$2,040	\$2,153	\$1,587
19	32	32	MAN-32	-	?	\$2,474	\$2,757	\$2,900	\$3,182	\$3,465	\$2,050
19	44	44	MAN-44	-	?	\$2,969	\$3,308	\$3,477	\$3,816	\$4,158	\$2,459
			MAN-44	EL	?	\$3,674	\$4,013	\$4,182	\$4,521	\$4,863	\$3,164

SPARKEOLOGY

Ben

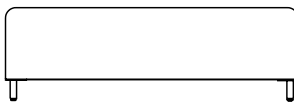
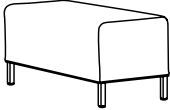

YARDAGE REQUIREMENTS

BEN-3219 2 yards
 BEN-4419 3 yards
 BEN-5619 3 yards

- Legs are 3" round nickel welded to an 11 gauge top plate
- 1-3/8" diameter black nylon leveling glides with a stainless steel stem
- Trim is 11 gauge steel fastened proud to underside of the case
- Available with and without power. One AXIL-Z power unit included with power option, available in black or white - please note desired location with order
- Cushion includes a top panel of 3" thick, fire retardant polyurethane foam
- Fabric yardage requirements are based on 54" wide plain fabric. Please contact customer service for fabrics with repeats or different widths to determine yardage requirements
- Upholstery is a tight, weltless design
- Foam meets California Technical Bulletin 117 for flammability
- Ships fully assembled

H	D	W	Part #	Power	Fabric Grade	GR 1 Price	GR 2 Price	GR 3 Price	GR 4 Price	GR 5 Price	COM Price
19	19	32	BEN-3219	-	?	\$1,645	\$1,760	\$1,815	\$1,930	\$2,043	\$1,477
			BEN-3219 (power included)	EL	?	\$2,350	\$2,465	\$2,520	\$2,635	\$2,748	\$2,182
19	19	44	BEN-4419	-	?	\$1,886	\$2,058	\$2,143	\$2,313	\$2,483	\$1,633
			BEN-4419 (power included)	EL	?	\$2,591	\$2,763	\$2,848	\$3,018	\$3,188	\$2,338
19	19	56	BEN-5619	-	?	\$2,028	\$2,198	\$2,283	\$2,453	\$2,622	\$1,773
			BEN-5619 (power included)	EL	?	\$2,733	\$2,903	\$2,988	\$3,158	\$3,327	\$2,478

Sofia

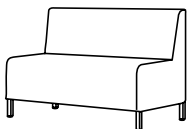

- The seat frame is constructed of one horizontal panel fabricated from upholstery grade, 15/16" thick, 7-ply fir plywood
- Cushion top panel is 3" thick, fire retardant polyurethane foam of 2.8 lb density and 80 lb IFD. The vertical outside surfaces are 1/4" inch thick, fire retardant polyurethane foam of 1.6 lb density and 55 lb IFD at 25% deflection
- Meets California Technical Bulletin 117 for flammability. Class A fire rated in accordance with Commercial Standard CS-191-53
- Fully upholstered unit is in accordance with BIFMA F-1-1978 (Rev. A80), First Generation Voluntary Upholstered Furniture Flammability Standard for Business and Institution Markets
- Power models include AXIL-Z flush mounted receptacle available in black or white

H	D	W	Part #	Fabric Grade	GR 1 Price	GR 2 Price	GR 3 Price	GR 4 Price	GR 5 Price	COM Price
32.75	25.5	48	SOFIA-4826	?	\$3,588	\$3,928	\$4,098	\$4,439	\$4,779	\$3,114
32.75	25.5	72	SOFIA-7226	?	\$4,534	\$4,873	\$5,043	\$5,383	\$5,723	\$4,060
32.75	25.5	48	SOFIA-4826-EL (power included)	?	\$4,293	\$4,633	\$4,803	\$5,144	\$5,484	\$3,819
32.75	25.5	72	SOFIA-7226-EL (power included)	?	\$5,239	\$5,578	\$5,748	\$5,383	\$6,428	\$4,764

Oscar



- Choose laminate color and size of your recycling job with the two or four bin unit. Matte nickel steel legs and drawer pulls come standard on every Oscar
- Stainless steel flush mounted inserts
- Matte nickel steel legs and door pulls
- 1-3/8" diameter black nylon leveling glides with a stainless steel stem
- Trim is 11 gauge steel fastened proud to underside of the case
- Oscar-2 includes two 23 gallon Slim Jims, Oscar-4 includes four 23 gallon Slim Jims
- Laminate available in Frosty White, Slate Grey and Black

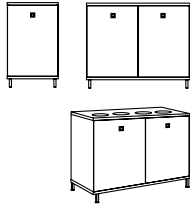

H	D	W	Part #	Price
39.9	24	24	OSCAR-2	\$3,785
39.9	24	48	OSCAR-4	\$5,528

Lily



- Integrated pen groove and cupholder

H	D	W	Part #	Metal #	Price
24.5	15.75	24	LILY	?	\$1,019

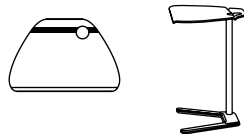

Flip



- The powder coated side panels are 12 gauge steel that is laser cut and contoured
- Resin shelf
- The seat has (4) decorative, color matching, snap rivets to protect the surface when being used as a bag holder
- Open side edges are protected by a color matched u-channel the length of the unit when being used as a seat or a table

H	D	W	Part #	Metal #	Price
20	11	16	FLIP	?	\$691

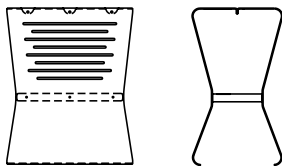

These conditions of sale supersede all previous selling policies. Prices, discounts, lead-times and product offerings are subject to change without notice.

Order Placement

Great Openings requires that all orders be submitted in writing to avoid errors and/or duplication. Sales of all Great Openings' products are made only on the Company's standard terms and conditions of sale, unless modified in writing by an authorized Great Openings representative.

Orders received at Great Openings after 4:00pm EST will be processed the following day.

Order Acknowledgement

We diligently issue order acknowledgements via e-mail within 24 hours of purchase order receipt. If you do not receive an acknowledgement within 24 hours, please call our Customer Service department to determine the reason; we may not have received your order, or we may have questions that are delaying order entry.

**PLEASE CHECK
ACKNOWLEDGEMENTS
FOR ERRORS
IMMEDIATELY UPON RECEIPT.**

The order acknowledgement process is designed to ensure protection for both the buyer and the seller. We strongly urge the buyer to make sure the acknowledgement accurately reflects the intended purchase.

Order Discrepancies

Great Openings will not be held responsible for extra costs due to errors resulting from purchase order inaccuracies. If and when a discrepancy is detected on the purchase order or acknowledgement, all corrections must be received in writing before further order processing can occur.

Changes, Cancellations

Orders may not be changed, corrected or cancelled, in whole or in part, after Great Openings has issued its order acknowledgement without the written consent of an authorized Great Openings representative. Special order items (special or custom cabinets, Customer's Own Materials (COM) fabric and laminates) already in production are not subject to change or cancellation under any circumstances.

Canadian Orders

Canadian orders may be processed using this price book. The pricing and payment terms included in this book are in U.S. funds. Custom brokerage fees and GST/HST taxes will be charged as separate line items on the invoice. All prices are freight included; FOB: Destination. A Regional Small Order Freight Charge applies to all orders less than \$5,000 list (does not apply to accessory orders). See regional map for applicable fee.

Lead-Time

Lead-times are measured in working days, and begin after receipt of clean order.

Lead-times may change without notice. Stated lead-times will not commence until purchase order is actually entered into our system. We are not responsible for delays caused by order discrepancies or late receipt of COM items.

Special Shipping Instructions

Great Openings will accommodate special shipping/delivery requests whenever possible. Purchaser will be responsible for any and all extra costs incurred by reason of Great Openings complying with a special shipping request. Examples of special requests that may cause extra charges (dollar amounts shown are approximate, actual amounts may vary):

- special carrier/lift gate: starting at \$85.00
- inside delivery: starting at \$50.00
- expediting, re-consignment, delays causing carrier storage: starting at \$50.00
- truck load delivery times after 3:00 pm, Monday through Thursday start at \$400
- truck load delivery after 3:00 pm, on Friday: \$800
- delivery times outside normal business hours including weekends and holidays: starting at \$450.00 per truck
- exact, narrow scheduling window (elevator time): starting at \$150.00
- non-commercial/residential deliveries: starting at \$60.00

The maximum amount of time allowed for off-loading product from trailers is 3 hours. Carrier costs associated with any additional delivery time will be charged to the dealer. Any additional charges that result from the purchaser failing to accept a shipment as agreed upon will be the responsibility of the purchaser.

Special Delivery Charges

Once a delivery truck arrives at a destination, if the recipient is not ready to accept delivery as scheduled and the truck must wait, deliver "after hours", or make a second drop at a later time, the carrier charges a penalty for that delay which Great Openings must pass on to the customer.

These charges are as follows (dollar amounts shown are approximate, actual amounts may vary):

Night Delivery:

3:30-4:30 p.m.: \$400 additional charge
4:30-5:30 p.m.: \$450 additional charge
5:30 p.m. and later: \$500 additional charge
Detention fee will be \$75 per hour after two hours. Drop charge will be \$75 per drop.

Weekend and holiday deliveries will be quoted per load depending on location and delivery time.

Please use caution when planning and communicating delivery requirements so that these exorbitant fees will not be necessary.

Key-Alike Services

Key-alike service is offered free of charge provided the key-alike request is associated with an order for a matching quantity of cabinets. Additional key/core sets, master and core keys are available for a nominal charge. All Great Openings products are keyed randomly prior to shipment. Special cores and keys are shipped separately to be changed-out in the field. See the Specification Guide in the front of this book.

COM & Fabric Grades

If COM materials are difficult to apply or inadequate, Great Openings reserves the right to apply extra charges or to cancel the order. Great Openings has no control over COM material quality or performance and will not be held responsible for material defects or damage caused by improper use or application.

Limited Lifetime Warranty

Great Openings warrants its Great Openings brand Metal Case-goods, Trace and Cayenne Desks, Files, Storage, Lockers and Sparkeology products to be free from defects in materials and workmanship for the life of the product, except as set forth below. This warranty applies to Great Openings products delivered in the United States and Canada and is non-transferable. The warranty is valid from the date of delivery to the End User. This warranty does not cover ordinary wear and tear, improper installation, outdoor use, or direct mis-use of the product. This warranty does not apply to Customer's Own Materials (COM) for fabric, laminates, or edge bands. In addition, supplier warranties will apply to products not manufactured by Great Openings. End User means the final purchaser acquiring a product from Great Openings or the Great Openings Dealer channel for the purchaser's own use and not for resale, remarketing or distribution. Great Openings will not be liable for loss of time, inconvenience, commercial loss, incidental or consequential damages.

EXCEPTIONS TO THE LIFETIME COVERAGE

Laminate Lockers – 12 years

Single, Double, Multi-purpose, Quad, and Cubby Laminate Lockers and includes both TFL and HPL options.

Tables – 5 years

Sparkeology Line Products: Pete and Oscar

Seating and Tables – 2 years

Height Adjustable Tables, Sparkeology Line Products: Ben, Manny, Sly, Sophia, Cupcake, and Lily

High Wear Parts – 1 year

Mobile Storage Casters, Gas Rods, Cushion Pads, Hinges, Power and Electrical components

Surfaces Materials Disclaimer:

- Exact matching of surface finishes, including an exact match to cuttings, samples, or swatch cards are not covered.
- Changes in surface finishes and colorfastness due to aging, exposure to artificial light or exposure to direct sunlight are not covered.

Credit Card Transaction Fee

Credit card payments in excess of the following thresholds will be subject to a 2.16% transaction fee. Please note that Great Openings also accepts payments via ACH, wire transfer, and check – all free of charge.

Type of Sale	Credit Card Threshold (per sales order)	Fee Assessed for Amount Over this Threshold
Commercial	\$10,000.00	2.16%
GSA: Project in USA	\$20,000.00	2.16%
GSA: Project outside of USA	\$30,000.00	2.16%

Regional Pricing

Great Openings reserves the right to adopt regional discount programs and small order freight charges to address the freight cost impact applicable to each geographic region. A buyer's region will be determined by shipping destination.

Payment Terms

Orders are invoiced at the time of shipment and payment is due upon receipt of the invoice. Invoices unpaid thirty (30) days after the invoice date are subject to a late payment charge in the amount of one and one-half percent (1-1/2%) per month on the unpaid balance until paid. Great Openings reserves the right to modify or establish special credit arrangement for any customers at any time at its sole discretion. All prices are subject to change without notice.

Remit to: Great Openings
Dept. for Lockbox: 9521-11
PO Box 30516
Lansing, MI 48909-8016

Taxes

All sales, use, excise and other applicable taxes (excluding only taxes on the net income of Great Openings) are the purchaser's responsibility and will be invoiced to the purchaser. If purchaser claims an exemption from such taxes, it shall be the purchaser's responsibility to furnish an appropriate exemption certificate to Great Openings.

For Canadian orders, Great Openings does invoice and collect for GST/HST.

Freight Policy

All prices are freight included, F.O.B. Destination. Prices are based on a single shipment to a single location. A Small Order Freight Charge applies to all orders less than \$5,000 list (does not apply to orders for accessories).

See the map below for Small Order Freight Charge by destination. Effective March 1, 2017, orders totaling less than \$5,000 list that are shipped to Michigan, Wisconsin, Illinois, Indiana, Ohio, Kentucky, and West Virginia a Small Order Freight Charge of \$100 net will apply. For orders totaling less than \$5,000 list that are shipped to the remainder of the continental U.S. and southern portions of Canada as shown on the map, a Small Order Freight Charge of \$200 net will apply. For Alaska, Hawaii, and all other portions of Canada, please call for a quote.

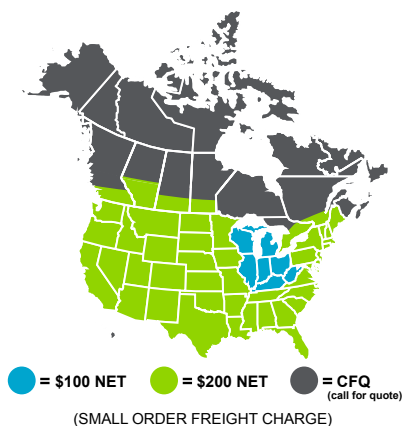

A flat rate \$15 FedEx shipping and handling fee will be charged at time of purchase order to handle incidental small product packages (i.e. keys, name plates, file bars, etc.).

Standard Packaging

All Great Openings' products are packaged in accordance with industry standards and common carrier requirements. Pedestal products are individually boxed with polystyrene corner guard inserts, then palletized, and shrink wrapped. Lateral and storage product packaging consists of corrugated top and bottom trays, corner guards, palletized, shrink wrapped and labeled. For full truckloads only, upon special requests, we can provide a blanket wrapped shipment; please call for a quote.

Shipment and Delivery

Freight is included in the prices as displayed in this price book. All shipments are FOB destination: free freight to destination in the continental United States. Shipments outside the contiguous 48 states will be freight collect from exit port. Exception for Canadian shipments; see the section on Canadian orders. Great Openings will select the mode and carrier of shipment.

- Partial shipments may be necessary and are at the discretion of Great Openings.
- Great Openings cannot guarantee exact time of delivery.
- Any charges resulting from late deliveries beyond our control are not the responsibility of Great Openings.
- Ship dates contained in order acknowledgements are estimated and not guaranteed.

Great Openings will often consolidate orders to maximize shipping efficiency. In these situations, a customer's designated ship date may change, though Great Openings will make every effort to ensure that requested delivery dates are still met.

Product Storage Fees

Once an order enters production, it is not possible to stop production on that order if a last-minute request is made to delay shipment. If it is absolutely necessary to hold the product at Great Openings for a later ship date, a holding fee of \$7 net per pallet or \$100 net per trailer will be assessed each week and partial week until the product ships. Weekly storage fees will be the responsibility of the purchaser on any delayed shipment of a produced order.

Returns

Great Openings will not accept returned goods.

Claim Policy

It is the purchaser's responsibility to examine goods upon receipt and to notify Great Openings customer service with any concerns. Any claims against Great Openings for apparent defects, errors or shortages must be made by the purchaser within five (5) working days after any delivery. Failure by the purchaser to make any claim against Great Openings within (5) days shall constitute acceptance of the goods and waiver of any apparent defects, errors or shortages.

Freight Damage Claims

Great Openings' terms are FOB destination, Great Openings is not responsible for damage that occurs in transit. All Great Openings' products are carefully inspected prior to shipment. The carrier signs for all goods received in apparent good order.

It is the buyer's responsibility to inspect goods upon receipt for both apparent and concealed damage. In the rare instance where shipping damage is found, we ask the purchaser NOT to refuse shipment. Accepting shipment will give us more opportunities to remedy the situation through parts (fronts, tops) replacement and within the guidelines of the stated terms.

Claim and Replacement Policy

In the case of documented shipping damage, Great Openings will file a claim with the carrier and issue at no charge any replacement parts or product only if the purchaser meets the following conditions:

- Product is shipped via a Great Openings designated carrier
- Accept the shipment
- Retain packaging
- Inspect the shipment and document damage on the bill of lading
- Contact Great Openings immediately upon discovery and documentation of damage

Failure of purchaser to meet these conditions will prevent Great Openings from obtaining carrier reimbursement and thereby require us to charge full price for product replacement.

Great Openings is not responsible for labor or trip costs associated with freight damage product replacement.

Concealed Damage Policy

Concealed damage (damage discovered after acceptance with no bill of lading documentation) should be reported to Great Openings immediately upon discovery. Please retain packaging and request carrier inspection immediately. Carrier liability ceases 7 calendar days after receipt of shipment. Great Openings will investigate on a case-by-case basis. In any case, Great Openings assumes no liability beyond the 7-day carrier liability and reserves the right to apply no remedy and/or various remedies dictated by individual event circumstances.

The buyer may make NO DEDUCTION UNDER ANY CIRCUMSTANCES ensuing from freight claims when settling invoices with Great Openings.

Service

Please contact Great Openings with any service concerns:

Great Openings
 902 E. Fourth Street
 Ludington, MI 49431
 Ph: 888-712-8582

- Metal filing, storage, and freestanding desk products
- Contract Number: GS-28F-0001S
- Current Contract Period: October 1, 2015- September 30, 2025
- Great Openings/Metalworks tax ID: 38 189 8020

- FSC Schedule MAS - Office Furniture
- Special Item Numbers (SIN) 33721
- Certified Small Business
- greatopenings.com

1a) Special Item Numbers Awarded:

SIN 33721 Work surfaces, Workstations, Computer Furniture and Accessories Filing and Storage Cabinets, Shelves, Mobile Carts, Dollies, Racks, and Accessories

1b) Lowest Priced Item:

SIN 33721 6" Drawer Divider ECOX 1070- 1 (\$11.00 list)

1c) Hourly rates not applicable

2) Maximum Order:

SIN 33721 \$250,000 net

3) Minimum Order:

SIN 33721 \$50.00

4) Geographic Coverage:

All 48 contiguous states and the District of Columbia. Port of embarkation for delivery to Alaska, Hawaii, Puerto Rico, The Virgin Islands. U.S. Government installations overseas.

5) Point of Production:

Ludington, Michigan; Manistee, Michigan

6) Discount From List Prices

69.8%

7) Tier Discounts:

Tier discounts are available, call for details.

8) Prompt Payment Terms:

Net 30 Days

9a) Government Purchase Cards - Below Micro Threshold:

Visa and MasterCard accepted

9b) Government Purchase Cards - Above Micro Threshold:

Visa and MasterCard accepted

10) Foreign Items:

None (All products are manufactured, painted and assembled in U.S.)

11a) Time of Delivery:

Shipment: When applicable, within our standard lead-time, which is noted in the Commercial Terms and Conditions.
Delivery: 30 days after receipt of order.

11b) Expedited Delivery:

Considered on a case-by-case basis.
Call Great Openings for availability and cost.

11c) Overnight and Two-Day Delivery:

Considered on a case-by-case basis
Call Great Openings for availability and cost.

11d) Urgent Requirements:

Considered on a case-by-case basis.
Call Great Openings for availability and cost.

12) F.O.B. Destination, Freight Prepaid and Allowed:

48 Contiguous States and Washington D.C.

For orders totaling less than \$1,000 net that are shipped to the western U.S. (including Montana, Wyoming, Colorado, New Mexico, Texas and all states west), the state of Florida, and New York City (including the Bronx, Brooklyn, Manhattan, Queens, and Staten Island), a Small Order Handling Fee of \$100 will apply. For orders totaling less than \$1,000 net that are shipped to the remainder of the U.S., a Small Order Handling Fee of \$50 will apply.

13a) Ordering Address:

Great Openings
902 E. Fourth Street
Ludington, Michigan 49431
Phone 888-712-8582
goorders@greatopenings.com

13b) Ordering Procedures:

For supplies and services, the ordering procedures, information on Blanket Purchase Agreements (BPA's), and a sample BPA can be found in Federal Acquisition Regular (FAR) 8.405-3.

14) Payment Address:

Great Openings
Department for Lockbox: 9521-11
P.O. Box 30516
Lansing, MI 48909-8016

15) Warranty Provision:

Lifetime Warranty
See warranty section for complete details in the Commercial Terms and Conditions.

16) Export Packaging Charges:

Quoted upon request

17) Terms And Condition of Government Purchase Card:

See item 9a + 9b. No additional discounts given.

18) Terms and Conditions of Rental, Maintenance and repair:

Not Applicable

19) Terms and Conditions of Installation:

Contact dealer or installation representative.

20) Terms and Conditions of Repair Parts:

Not Applicable

20a) Terms and Conditions for Any Other Services:

Not applicable

21) List of Service and Distribution Points:

Not Applicable

22) List of Dealers:

Please contact Great Openings for your nearest Great Openings Dealer.

23) Preventative Maintenance:

Not offered

24a) Environmental Attributes:

Has an active environmental program. Please contact Great Openings Dealer.

24b) Section 508 Electronic Compliance:

Currently not available

25) DUNS Number:

00-495-0549

26) SAM:

Great Openings is registered with the System For Award Management database. Cage Code: 33LN6

Cancellation Policy:

Orders may not be cancelled or changed without approval from Great Openings. If an order is cancelled prior to production, no cancellation charge will apply.

After production has begun, the Government will pay actual costs that the contractor can demonstrate if the product is not sold in a reasonable length of time (3 months).

Returns / Restocking Charge:

The Government will pay a 33% restocking charge.

The customer agency must obtain written authorization from Great Openings before returning any product. The customer agency will pay all return freight charges. Product returned in damaged condition will not be accepted.

DOD Requirements for Wood Packaging:

DOD's requirements (ISPM 15) for wood packaging material (WPM) are designed to block the movement of forest-destrating pests from one nation to another. Please clearly mark DOD-related purchase orders so that the required packaging can be included.



902 East 4th Street
Ludington, MI 49431
888-712-8582
greatopenings.com
goorders@greatopenings.com